

# LK3–B430EMark II

## Electronic Lockstitch Bar Tacker



### Specifications

	-1, -5	-2	-7
Application	Ordinary materials	Denim	Knitted materials
Stitch formation	Single needle lock stitch		
Max. sewing speed	2,700 rpm		
(X × Y) Max. pattern size	Max. 30 × 10 mm		
Feed mechanism	R–θintermittent feed mechanism (pulse–motor driven mechanism)		
Stitch length	0.1–10.0 mm		
No. of stitches	Variable (14, 15, 19, 21, 22, 28, 29, 30, 35, 42, 43, 45, 56, 58, 64 stitches pre–set)		
Max. stitch number	20,000 stitches (including 10,000 stitches which can be added.)		
Work clamp lifter	Solenoid type		
Work clamp height	17mm max.		
Hook	Shuttle hook (× 2shuttle hook, optional)		
Wiper device	Standard equipment		
Thread trimmer device	Standard equipment		
Thread take-up device	Standard equipment	Option	Standard equipment
Data storage method	PROM (Any sewing pattern can be added using BAS–PC300.)		
No. of user programs	16		
No. of cycle programs	4		
No. of stored data	35 sewing patterns are set already. (Up to 100 patterns can be added. Total number of stitches of stored data which can be added is within 10,000.)		
Motor	Three phase 400W induction motor		
Weights	Machine head: 47kg, Option panel: 0.6kg, Control box: 9–19kg (depending on destination)		
Power supply	Single phase 110V, 220–230V, 240V Three phase 220V, 380V, 400V Maximum electric power consumption; 600VA		

## Main use

Jeans...Belt loop attachment, pocket top, front, crotch

Slacks...Belt loop attachment, side-pocket top, rear pocket, front jackets, foundation garments, underwear, etc.

## LK3-B430E Mark II-

Subclass	Materials
-1	Ordinary materials
-5	
-2	Denim
-7	Knitted materials

\*To prevent thread breakage due to heat, set the sewing speed to a maximum of 2,500 rpm for sewing ordinary materials and knitted materials.

\*The difference between -1 and -5 specifications is that the standard work clamp and feed plate are different.

## LK-B430E Mark II List of pre-programmed patterns

Spec.	Program No.	Sewing pattern	No. of stitches	Pattern size X-Y (mm)
Ordinary materials (-1)	1		42	16 × 2
	4		30	16 × 2
Ordinary materials (-5)	5		29	10 × 2
	8		21	7 × 2
	13		35	10 × 2
	15		42	10 × 2
	20		28	7 × 2
	21		35	7 × 2
Denim (-2)	2		42	20 × 3
	3		35	20 × 3
	6		30	16 × 3
	14		35	16 × 3
	16		43	16 × 3
	17		42	24 × 3
	18		56	24 × 3
	19		64	24 × 3

\*Length when the sewing size is 100%.

## LK-B430E Mark II List of pre-programmed patterns

Spec.	Program No.	Sewing pattern	No. of stitches	Pattern size X-Y (mm)
Knitted wear (-7)	7		14	8 × 2
	9		21	7 × 2
	22		28	7 × 2
	31		28	8 × 2
	32		22	8 × 2
	33		15	8 × 2
Straight tacking	10		21	10 × 0.3
	11		28	10 × 0.3
	12		28	20 × 0.3
	23		35	25 × 0.3
	24		42	25 × 0.3
	25		45	25 × 0.3

\*Length when the sewing size is 100%.

\*Use the presser foot and feed plate for straight bar tacking when using the straight bar tacking programs.

Spec.	Vertical bar tacking		Vertical straight tacking		
	Program No.	26	27	28	29
Sewing pattern					
No. of stitches	28	35	19	21	28
Pattern size X × Y (mm)	3 × 10	3 × 10	0.3 × 10	0.3 × 10	0.3 × 10

\*Length when the sewing size is 100%.

\*Use the presser foot and feed plate for vertical straight bar tacking when using the above programs.

Spec.	Crescent bar tacking	
	Program No.	34
Sewing pattern		
No. of stitches	35	58
Pattern size X × Y (mm)	12 × 7	12 × 7

\*Length when the sewing size is 100%.

\*Use the presser foot and feed plate for crescent bar tacking when using the left programs.

\* The left programs are added to the standard programs for the main P-ROM version MN-E and later.

# Optional device Thread take-up mechanism

< デニム用 (B430E, B433E) / For Denim (B430E, B433E) >

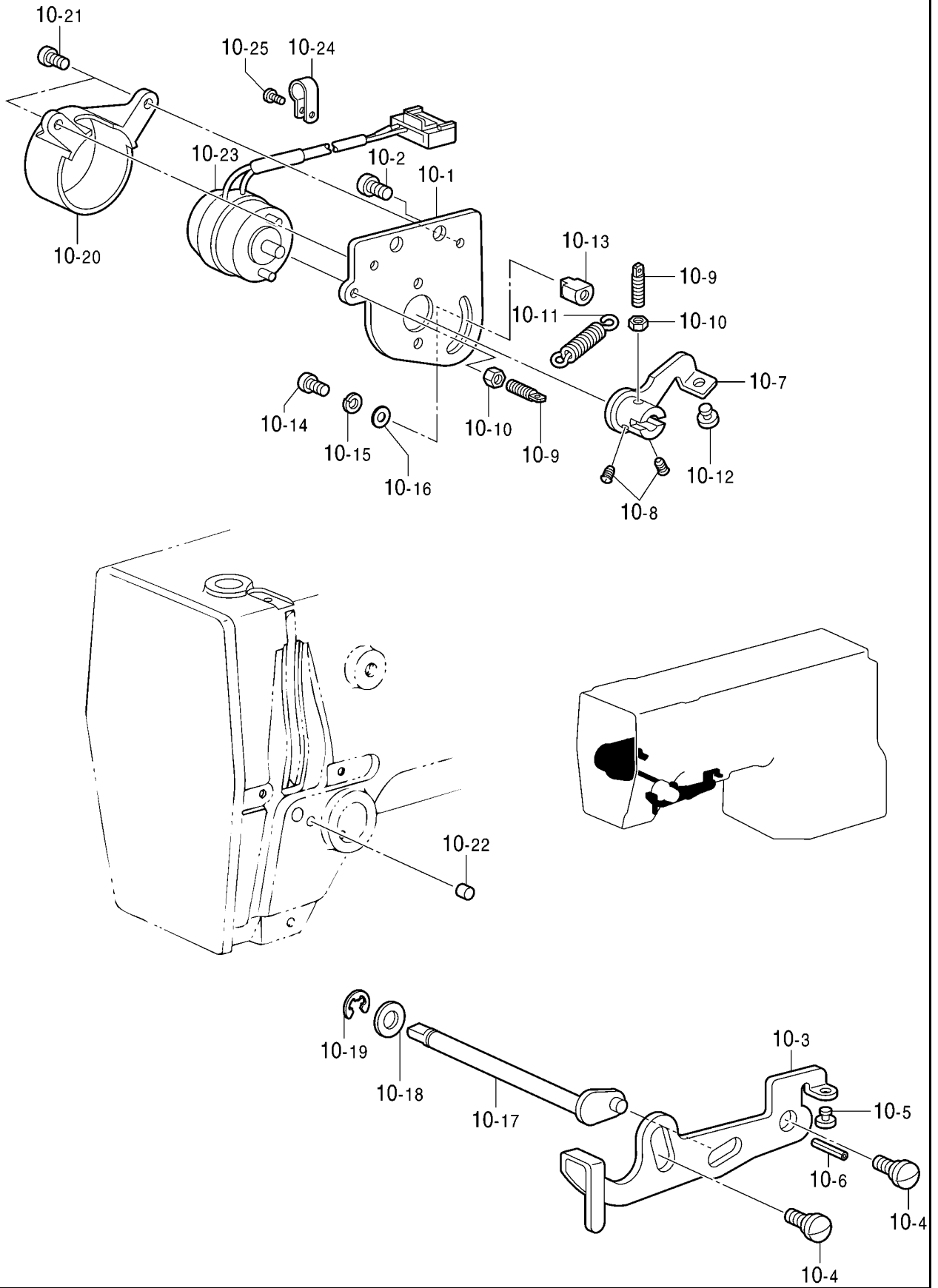





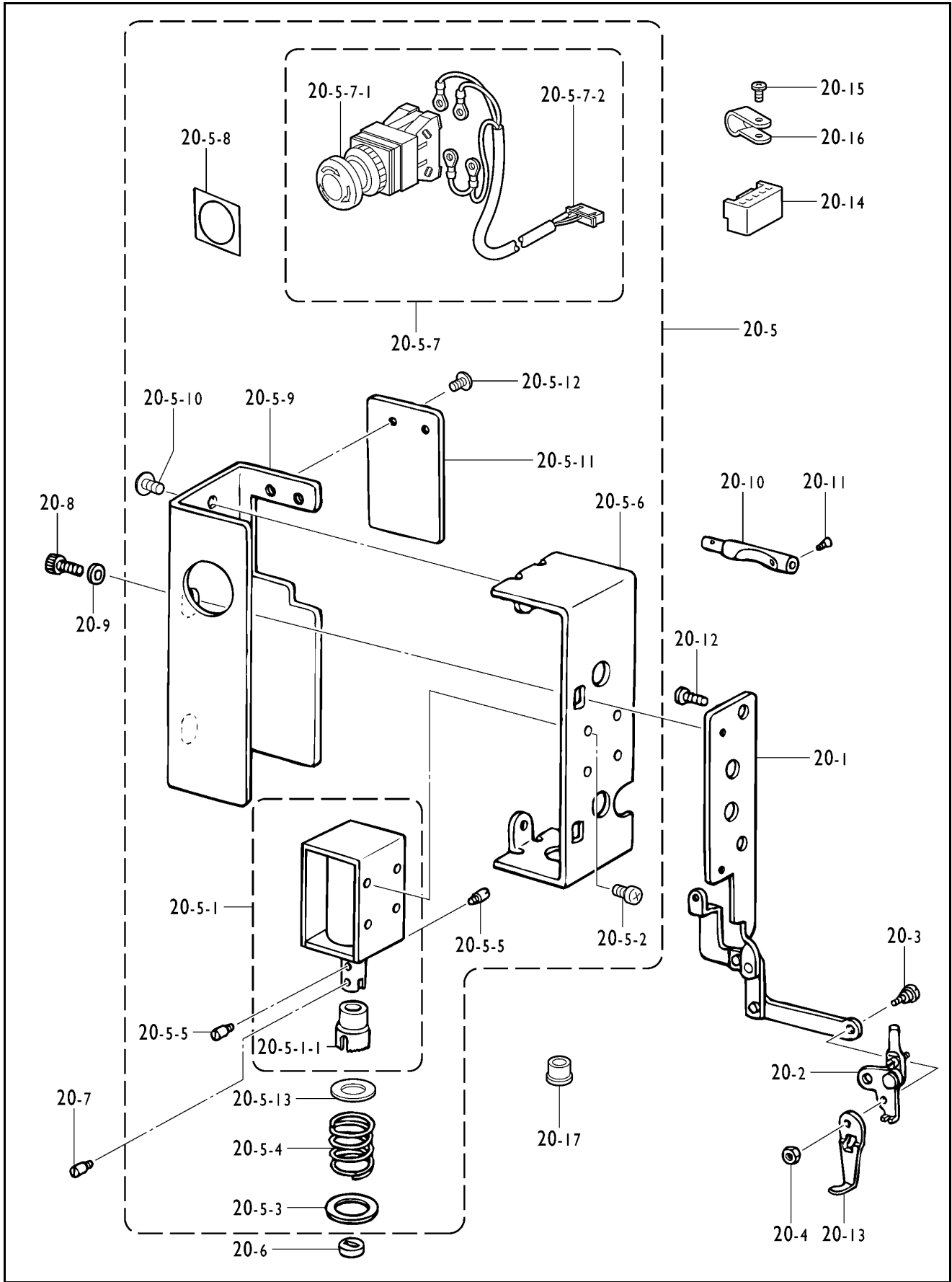







Ref. No.	Part name	Part code	Q'ty
<b>&lt;Option parts for Denim&gt;</b>			
10	Thread take-up device	S49956-001	1
10-1	Solenoid setting plate	S49659-001	1
10-2	Screw, pan SM4.76 – 32×8	062710-812	2
10-3	Thread take-up lever	S49660-001	1
10-4	Shoulder screw, SM4.76	107321-003	2
10-5	Differential crank cushion	S19748-001	1
10-6	Pin, spring roll AW4	047401-442	1
10-7	Thread trimming solenoid joint	S49661-001	1
10-8	Set screw, SM3.57	S01998-001	2
10-9	Spring hook	110251-001	2
10-10	Nut, 1 SM3.57	021670-102	2
10-11	Thread trimmer spring	S34883-001	1
10-12	Differential crank cushion	S19748-001	1
10-13	Nut, SM3.57	S49663-001	1
10-14	Screw, pan SM3.57 – 40×10	062671-012	1
10-15	Washer, spring 2 - 3.5	028350-242	1
10-16	Washer, plain L3.5	025350-332	1
10-17	Crankshaft	S49662-001	1
10-18	Washer, plain	155559-001	1
10-19	Retaining ring, E4	048040-342	1
10-20	Thread take-up solenoid cover	S49664-000	1
10-21	Screw, pan SM3.57 – 40×8	062670-812	2
10-22	Rubber cap, 5.3	S20878-000	1
10-23	Thread take-up solenoid	S49464-000	1
10-24	Cord holder, 5N	S00480-000	3
10-25	Screw, bind SM3.57 – 40×6	060670-612	3

**Optional device  
Solenoid thread wiper**



Ref. No.	Part name	Part code	Q'ty
20	Thread wiper solenoid assy	S49615-009	1
20-1	Thread wiper connect rodassy	S41656-001	1
20-2	Thread wiper armassy	S44600-001	1
20-3	Shoulder screw, SM3.57	153112-001	1
20-4	Nut, 2 SM3.57	021670-202	1
20-5	Solenoid box assy	S49616-009	1
20-5-1	Thread wiper solenoid assy	S49619-001	1
20-5-1-1	Plunger rubber	S41204-050	1
20-5-2	Screw, pan M3 x 6	062300-612	4
20-5-3	Washer, plain	S41205-001	1
20-5-4	Spring, t-wiper	S41206-001	1
20-5-5	Plunger pin	S25456-001	2
20-5-6	Setting plate, W-sol.	S42017-109	1
20-5-7	EM-lock switch harness assy	S49482-000	1
20-5-7-1	Switch, AVS311N	S32335-000	1
20-5-7-2	EM-switch harness	S49466-000	1
20-5-8	EM-switch spacer, 3	S37057-001	1
20-5-9	Solenoid cover, W	S42018-109	1
20-5-10	Screw, truss M4 x 6	008400-604	2
20-5-11	Solenoid cover lid, E	S37806-109	1
20-5-12	Screw, truss M4 x 6	008400-604	2
20-5-13	Washer, plain 13	115007-001	1
20-6	Spacer rubber	S41207-000	1
20-7	Plunger pin	S25456-001	1
20-8	Bolt, socket M4 x 6	018400-632	2
20-9	Washer	100645-003	2
20-10	Tension release rod, DW	S41657-001	1
20-11	Screw, flat M3.5 x 6	061350-616	1
20-12	Screw, pan SM4.37-40 x 8	062680-812	2
20-13	Thread wiper, A	156206-001	1
20-14	Connector	S49947-000	1
20-15	Screw, bind SM3.57-40 x 6	060670-612	3
20-16	Cord holder, 7N	149287-000	3
20-17	Rubber cap, 15.5	104449-009	1









## Different parts list

Specification	-2	-1	-5	-7
Use	For denim		For ordinary materials	For knitted materials
Part name				
Needle hole plate 	(φ2.6) S10212-101 E ○		(φ2.2) S49980-001 FM	(φ1.6) S10211-001 A ○
Bobbin case assy 	152690-301 B ◎		159610-201 A ◎	159610-201 A ◎
	S15902-401 LA ○		S15902-401 LA ○	
Tensionspring 	154340-001 B ◎		154339-001 A ◎	154339-001 A ◎
	S16074-101 LA ○		S16074-101 LA ○	
Screw 			154341-001 ◎	154341-001 ◎
			S16492-101 LA ○	
Spring, anti-spin 	154342-001 B ○		159612-001 A ◎	159612-001 A ◎
	S15667-001 LA ◎		S15667-001 LA ○	
Bobbin 			159613-051 ◎	159613-051 ◎
			S15665-001 LA ○	
Shuttle hook box assy 	152687-902 B ◎		152685-903 A ◎	152685-903 A ◎
	S15663-991 LB ○		S15662-992 LA ○	
Shuttle race body 	152686-101 B ◎		152682-101 A ◎	
Tensionspring 	107606-001 ◎		104525-001 ◎	
Spring 	144588-001 B ◎		145519-001 ◎	
Needle bar thread guide   A B	152890-001 A ◎		S41222-001 B ◎	

\*◎: Common with the LK3-B430E.

○: Common with the BAS-311E.



Specification	-2	-1	-5	-7
Use	For denim	For ordinary materials		For knitted materials
Part name				
Needle assy	S37928-419 	107415-414		107415-409 
Needle	DP × 17 NY #19 S37928-019 	DP × 5 #14 107415-014		DP × 5 #9 107415-009 
Work clamp arm assy	S49591-001	S49594-001	S49596-001	S51095-001
Work clamp, U	 5.6 × 23 (3mm) R. 153608-101 L. 154527-001 	 4 × 18 (2mm) R. 152777-001 L. 152778-001	 4 × 12 (2mm) R. 152779-001 L. 152780-001	4 × 12 (2mm) R. S49695-001 L. S49694-001
Feed plate	 S49697-001	12 × 31 (L / Submerged type, L) S49698-001	16 × 24 (S / Submerged type, S) S49700-001	5.4 × 13.4 (2mm) S49696-001

## Standard parts

Standard size for work clamps and feed plates are as follows.

(The actual sewing area has 1.5 mm margin on every size; inside the lines which the dimensions indicate.)

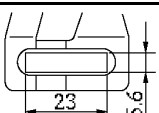
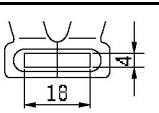
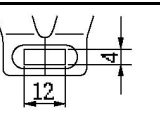
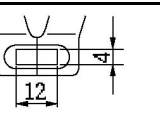
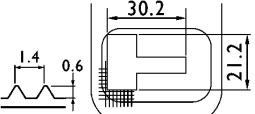
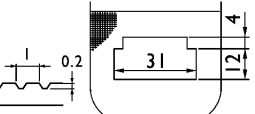
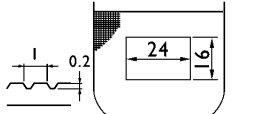
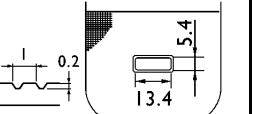
Spec.	-2	-1	-5	-7
R	153608-101	152777-001	152779-001	S49695-001
L	154527-001	152778-001	152780-001	S49694-001
Work clamp, U				
	S49697-001	S49698-001	S49700-001	S49696-001
Feed plate				

Standard needle hole plates are as follows.

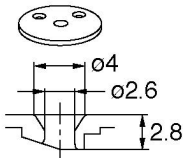
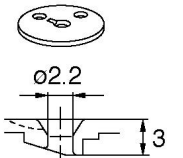
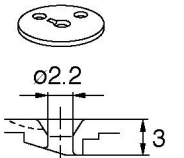
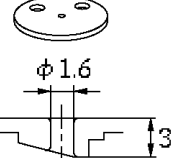
Spec.	-2	-1	-5	-7
	E S10212-101	FM S49980-001	FM S49980-001	A S10211-001
Needle hole plate				

## Gauge parts list (Optional parts)

\*Each work clamp pair is used in combination with the feed plate directly below them.

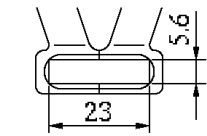
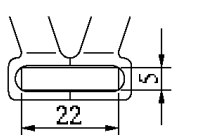
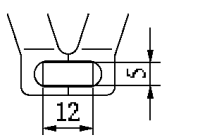
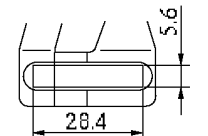
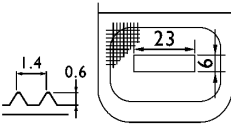
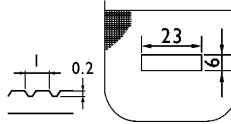
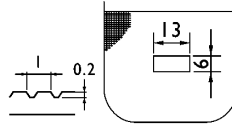
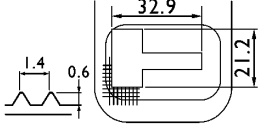
	1	2	3	4
R	152781-001 (For denim)	153201-001 (PL)	153203-001 (PS)	S00906-001 (1 inch)
L	152782-001 (For denim)	153202-001 (PL)	153204-001 (PS)	S00907-001 (1 inch)
Work clamp, U				
Feed plate	S49942-001 (For denim)	S49943-001 (PL)	S49944-001 (PS)	S49946-001 (1 inch)
				

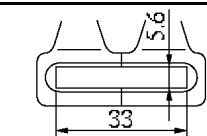
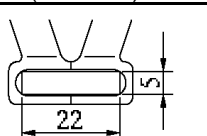
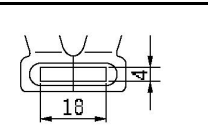
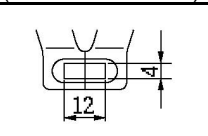
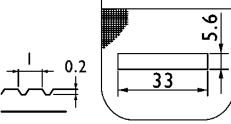
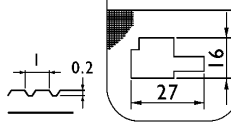
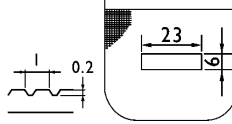
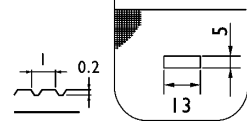
	5	6	7	8
R	S33747-001 (30mm)	153201-001 (For denim)	152777-001 (PM)	152779-001 (For knitted materials)
L	S33748-001 (30mm)	153202-001 (For denim)	152778-001 (PM)	152780-001 (For knitted materials)
Work clamp				
Feed plate	S49948-001 (30mm)	S49949-001 (For denim)	S49943-001 (PL)	S49699-001 (For knitted materials)
				

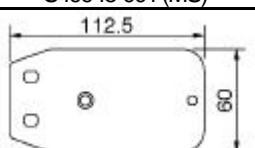
	9
Feed plate	S49945-001 (MS)
	

	10		11		12		13	
R	S46771-001 (For straight bar tacking)		S46771-001 (For straight bar tacking / submerged)		S46774-001 (For vertical bar tacking)		S46774-001 (For vertical straight bar tacking / submerged)	
L	S46770-001 (For straight bar tacking)		S46770-001 (For straight bar tacking / submerged)		S46773-001 (For vertical bar tacking)		S46773-001 (For vertical bar tacking / submerged)	
Work clamp, U								
Feed plate	S49970-001 (For straight bar tacking)		S49974-001 (For straight bar tacking / submerged)		S49971-001 (For vertical bar tacking)		S49975-001 (For vertical straight bar tacking / submerged)	
Work clamp, U	156006-001	017680-512	156006-001	017680-512	156006-001	017680-512	156006-001	017680-512
Bolt								

	14		15	
R	S46777-001 (For circular stitching)		S46780-001 (For crescent bar tacking)	
L	S46776-001 (For circular stitching)		S46779-001 (For crescent bar tacking)	
Work clamp, U				
Feed plate	S49972-001 (For circular stitching)		S49973-001 (For crescent bar tacking)	
Work clamp, U	156006-001	017680-512	156006-001	017680-512
Bolt				

\*Separate programs must be created if using 14 or 15.

### Gauge parts list (Optional parts)

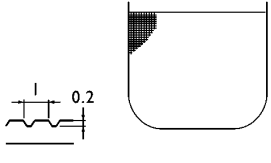
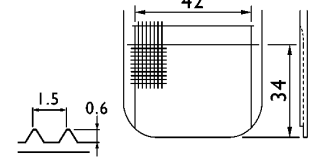
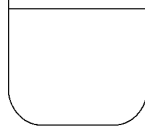
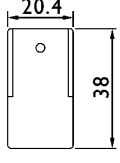
Feed plate blank		Work clamp blank	
S49976-000	S49977-000	S49978-000	155994-000
		 Without lozenge	

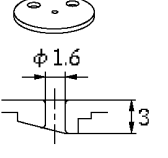
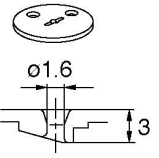
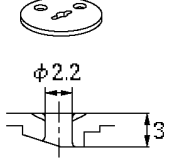
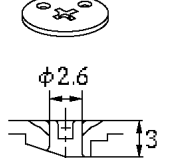
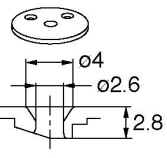
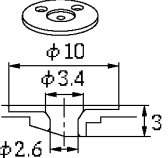
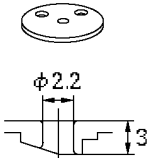
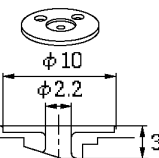
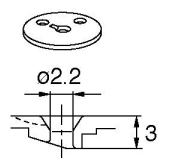
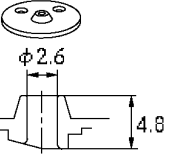
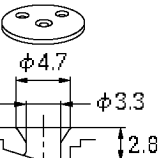
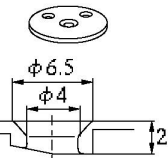
Needle hole plate											
A	S10211-001	AF	S51449-001	BZ	S41013-001	D	S29997-001	E	S10212-101	ED	S30925-001
											
(For knitted materials)								(For denim)			
F	S10213-001	FD	S30926-001	FM	S49980-001	H	S30450-001	L	S25127-001	M	S34348-001
											
		(For ordinary materials)									