

DT4-B281

Four Needle Double Chain stitcher

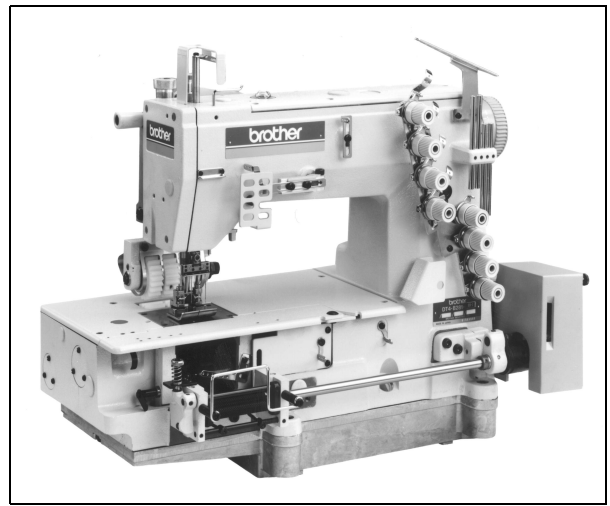

Specifications

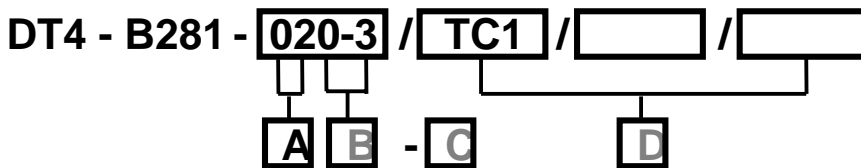

A	Specifications	Gauge	Needle size Schmetz (Organ) (UY113GS)	Max. stitch length (mm)	Height of presser foot (mm)	Max. sewing speed (rpm)
00	Plain stitching	0-2	# 75 - # 110 (# 11 - # 18)	3.6	7	5,000
		0-3				
		0-4				
		0-5				
		0-6				
		0-7				
		0-8				
		0-9				
		1-0				
		1-1				
02	Elastic gathered waistbands (With bottom metering device and puller)	0-1	# 75 - # 110 (# 11 - # 18)	3.6	7	5,000
		0-2				
		0-3				
		0-4				
		0-5				
04	Shirtfronts (With puller)	0-9	# 75 - # 110 (# 11 - # 18)	3.6	7	5,000
		0-1				
		0-5				
		0-6				
		0-7				
		0-8				
05	Waistbands (With puller)	1-0	# 75 - # 110 (# 11 - # 18)	3.6	7	3,500
		1-1				
		0-3				
		0-6				
		0-7				
06		0-6	# 120 - # 140 (# 19 - # 22)			

Specifications

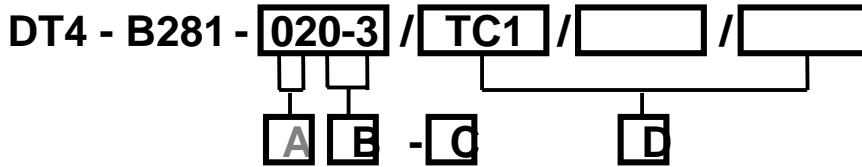

B	C	Needle gauge (inch)
0	1	3/4
0	2	1
0	3	1 1/8
0	4	1 1/4
0	5	1 1/2
0	6	1/4 - 1 - 1/4
0	7	3/16 - 7/8 - 3/16
0	8	1/4 - 3/4 - 1/4
0	9	1/4 - 1/2 - 1/4
1	0	3/16 - 1 - 3/16
1	1	3/16 - 3/4 - 3/16

D	Optional device		
TC1	Air-type tape cutter	For Japan	S16671-001
		For export	S16671-002
TC3	Solenoid-type tape cutter	For Japan 100 V	S15186-101
		For Japan 200 V	S15186-103
		For export 110 V	S15186-102
		For export 220 V	S15186-104
		For export 240 V	S15186-106
		For export 380 V	S15186-107
		For export 400 V	S15186-108
		For export 415 V	S15186-109

Option parts Lapper

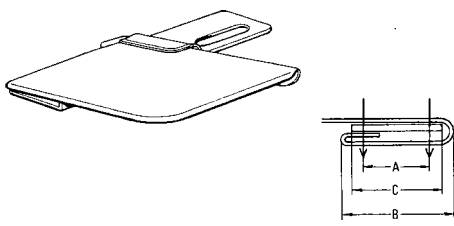
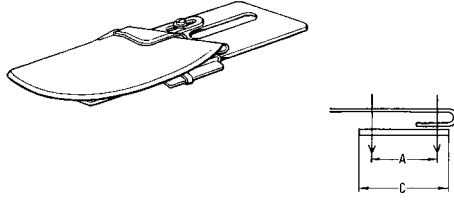
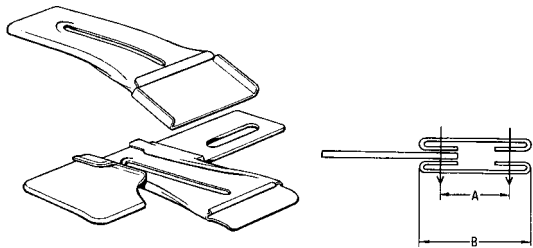
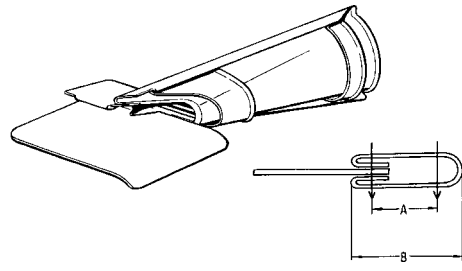
	Needle spacing (mm)	Finished size (mm)	Tape size (mm)	Part code
	A	B	C	
Elastic hemmer (Down turn) 	28.5	33	31	S15691-001
	25.4	30	28	S15691-002
	38.1	42	40	S15691-003
	19.1	25	23	S15691-004
	31.8	36	34	S15691-005
Elastic hemmer (Open elastic) 	-	-	Elastic max. Size 40	S15692-001
Top and bottom waistband attachment  * Order the lapper set plate assy (S18635-001) together.	38.1	42	65	S15693-001
	31.8	35	56	S15693-002
Right angle elbow binder 	38.1	42	110	S15694-001
	31.8	35	95	S15694-002
	25.4	30	85	S15694-003

Option parts

Lapper set plate assy

*For using the lapper for upper and lower waist band (S15693-001, S15693-002), order the parts listed below.

05
06

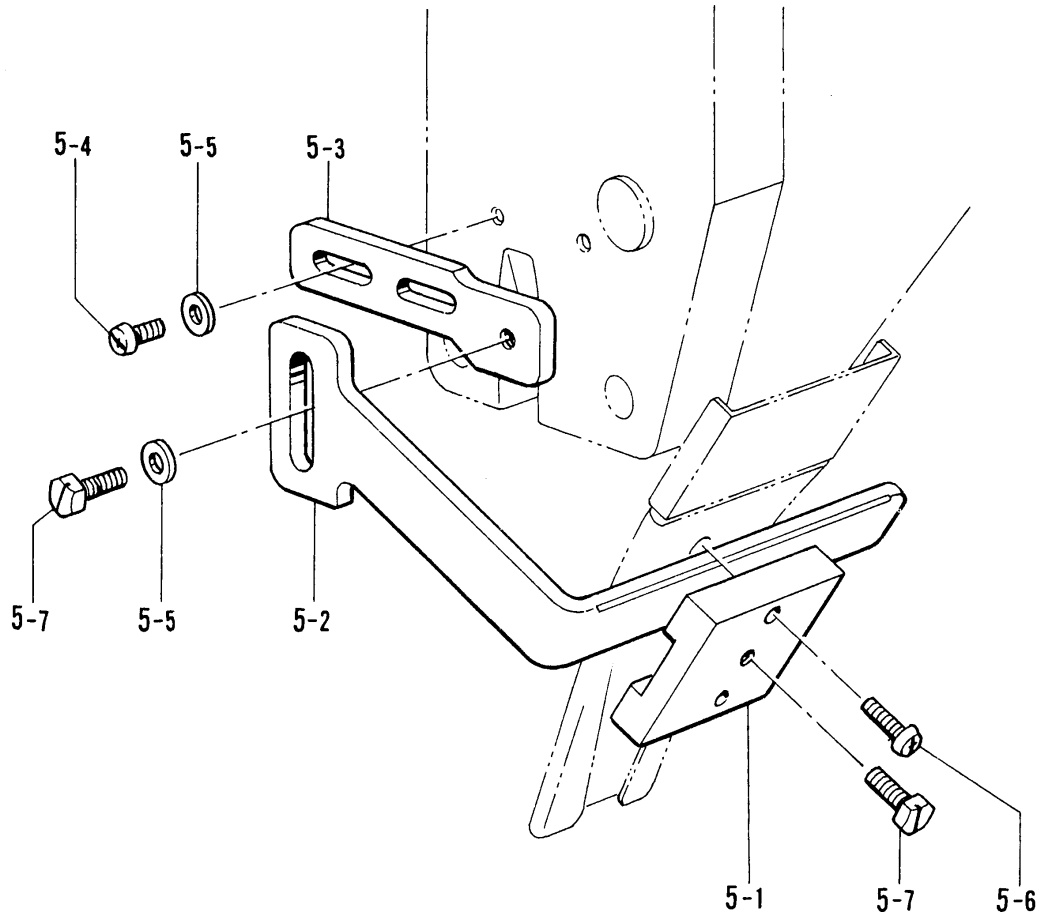

Ref. No.	Part name	Part code	Q'ty
	<05, 06> For top and bottom waistband attachment		
5	Lapper set plate assy	S18635-001	1
5-1	Lapper set plate	S18574-001	1
5-2	Angle plate	S18575-001	1
5-3	Angle bracket	S18576-001	1
5-4	Screw, pan M4.37-40 × 10	062681-012	2
5-5	Washer	146354-001	3
5-6	Screw, pan M3.57-40 × 12	062671-212	2
5-7	Bolt, M4.37	117516-001	2

Puller

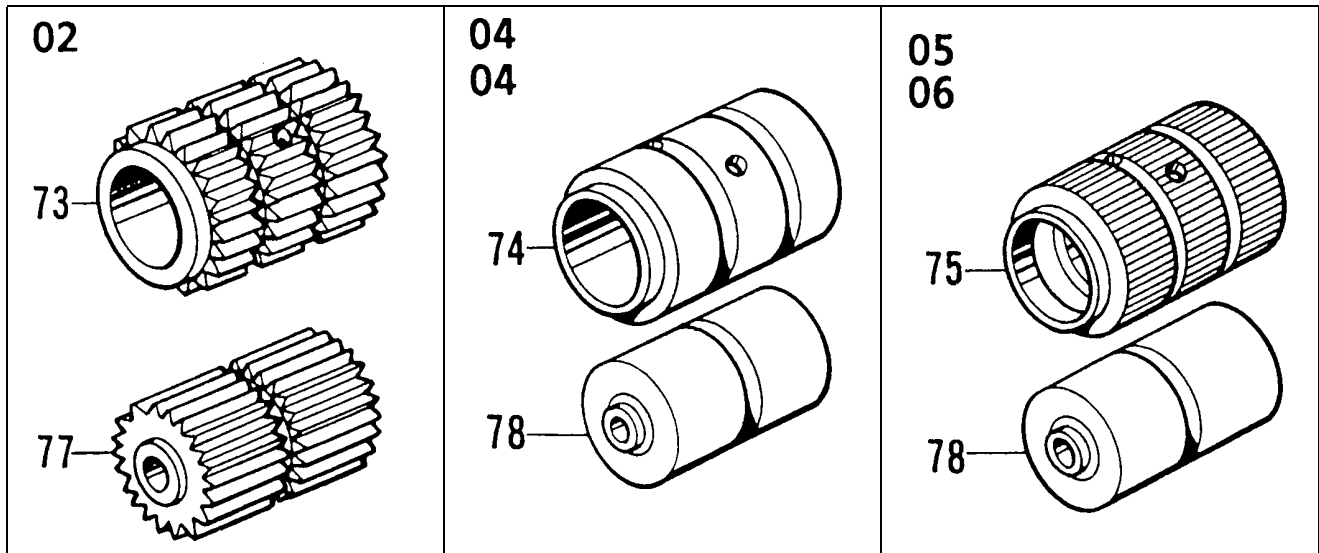

Ref. No.	Part name	Part code	Q'ty
	<02> For elastic gathered waistbands		
73	Plastic gear (U28)	S28875-000	1
77	Plastic gear (D23)	S28876-000	1
	<04> For shirtfronts		
74	Rubber roller (U)	S12956-001	1
78	Rubber roller (D) assy	S12959-000	1
	<05, 06> For waistbands of jeans		
75	Steel gear (U60)	S12957-001	1
78	Rubber roller (D) assy	S12959-000	1
	<02> Option parts		
73	Plastic gear (U22)	S12955-000	1
77	Plastic gear (D18)	S12958-000	1

Option parts 6 threads guide assembly

This is a part set required for converting from 4-needle specification to 6-needle specification. Use this set with the gauges available in the market.

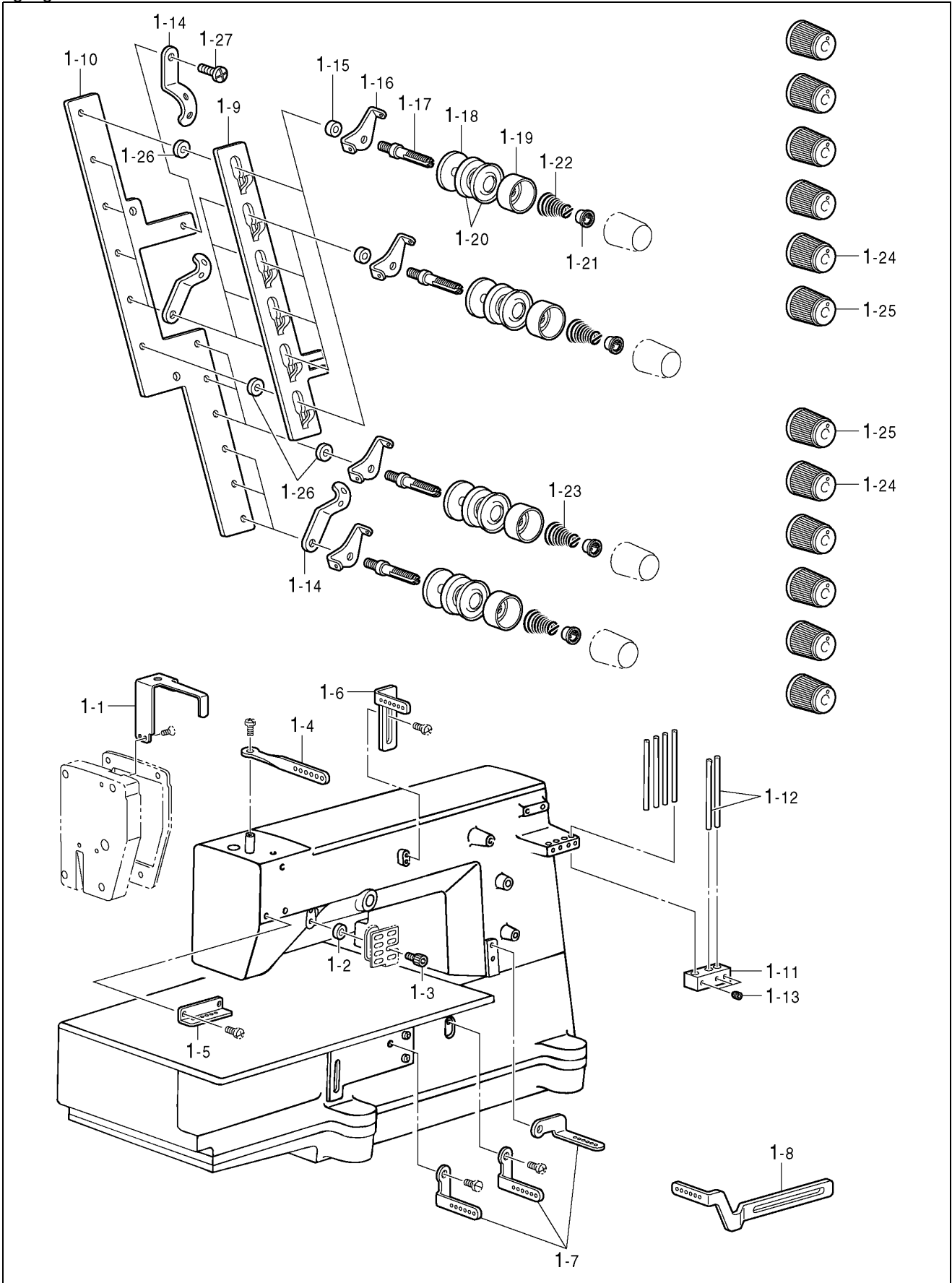





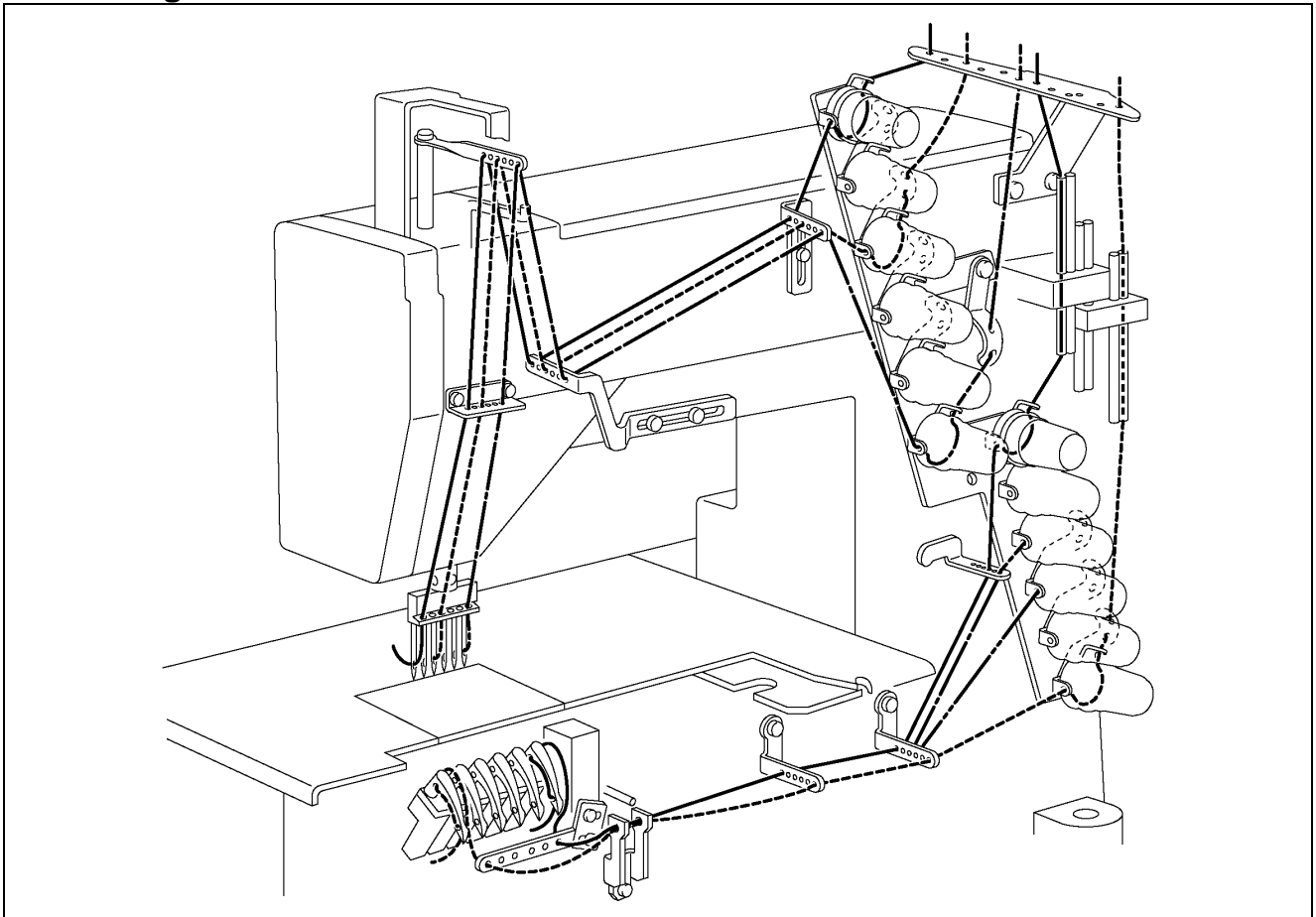



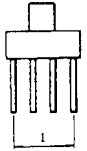
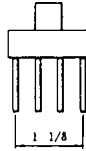

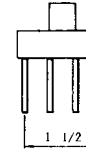
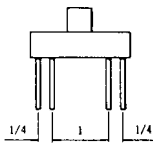
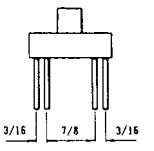
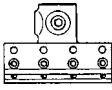
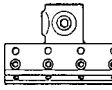
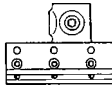
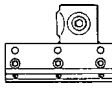
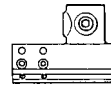
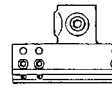
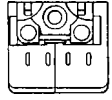
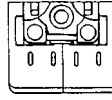
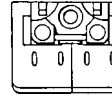
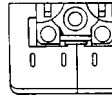
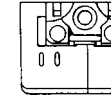
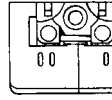
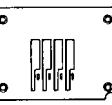
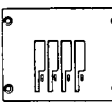
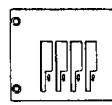
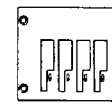
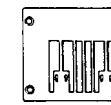
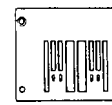



Ref. No.	Part name	Part code	Q'ty
1	6 threads guide assembly	S55634-001	1
1-1	Cover, ; N-bar & T/take-up	S55593-001	1
1-2	Collar	141617-001	1
1-3	Bolt, socket M6 × 12	018061-232	1
1-4	Thread take-up, ; N-bar 6	S55585-001	1
1-5	Thread guide, U6	S55586-001	1
1-6	Thread guide, 6	S55587-001	1
1-7	Thread guide, 6	S55588-001	3
1-8	Needle thread take-up, 6	S55589-001	1
1-9	Tension release plate, 6	S55590-001	1
1-10	Tension bracket, 6	S55591-001	1
1-11	Pipe support, ; TR-guide	S55592-001	1
1-12	Thread guide pipe, L	150645-009	2
1-13	Set screw, socket (CP) SM4.37	014680-432	3
1-14	Thread guide, ; T-bracket	S08963-001	4
1-15	Spacer	S08964-001	2
1-16	Thread guide, ; needle	110813-001	4
1-17	Tension stud	159574-101	4
1-18	Felt, ;T-disc	110832-009	4
1-19	Disc presser, ;tension	144103-009	4
1-20	Disc, tension	145446-001	8
1-21	Washer	S30564-000	4
1-22	Thread tension adjust spring	144104-001	2
1-23	Tension spring	S12872-001	2
1-24	Tension nut, red	S30565-003	2
1-25	Tension nut, light blue	S30565-001	2
1-26	Washer, plain 5	146354-001	5
1-27	Screw, pan SM4.37 – 40 × 6	062680-612	1

Threading







Gauge parts list

Specifications	000-2	000-3	000-4	000-5	000-6	000-7
Label	S12808-040	S12808-041	S12808-042	S12808-043	S12808-044	S12808-045
Application	For plain stitching					
Needle spacing (inch)						
Name of parts	A	B	C	D	E	F
Needle clamp assy	S13400-001 	S13401-001 	S13402-001 	S13403-001 	S13404-001 	S13405-001 
Presser foot assy	S12767-001 	S12774-001 	S12777-001 	S12780-001 	S12783-001 	S12786-001 
Needle plate	S12760-001 	S12761-001 	S12762-001 	S12763-001 	S12764-001 	S12765-001 
Feed dog	S12792-001 	S12793-001 	S12794-001 	S12795-001 	S12796-001 	S12797-001 
Retainer holder assy	S13407-001 	S13408-001 	S13409-001 	S13410-001 	S13411-001 	S13412-001 
Looper holder *	S12839-001 (4 piece)	S12839-001 (4 piece)	S12839-001 (4 piece)	S12839-001 (4 piece)	S12839-001 (4 piece)	S13814-001 (2 piece)
Needle size Schmetz (Organ)	#75 - #100 (#11 - #18)	#75 - #100 (#11 - #18)	#75 - #100 (#11 - #18)	#75 - #100 (#11 - #18)	#75 - #100 (#11 - #18)	#75 - #100 (#11 - #18)

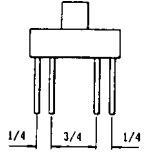
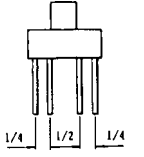
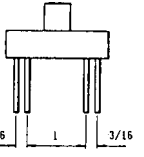
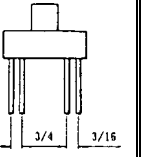
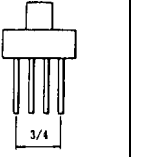
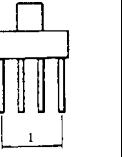
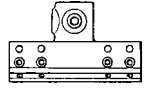
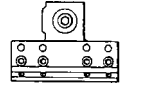
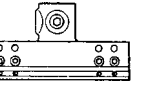
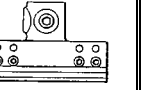
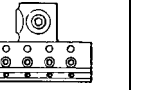
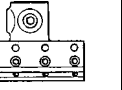
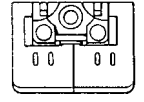
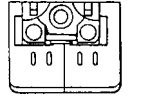
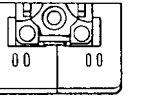
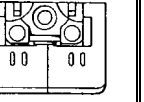
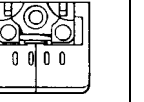
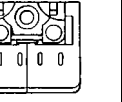
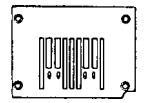
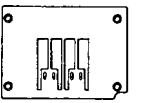
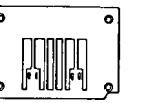
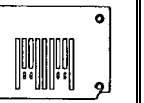
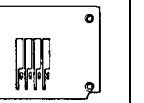
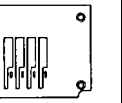
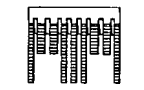
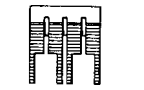
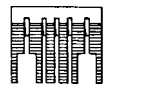
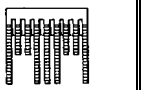
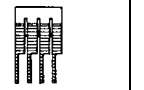
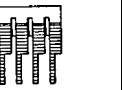

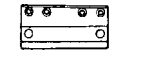
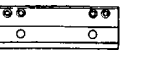
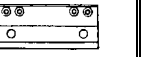

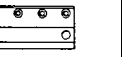



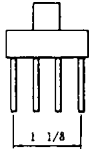
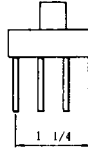
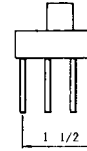
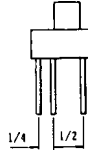
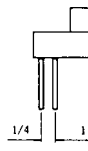
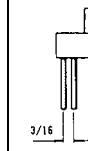
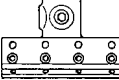
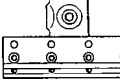
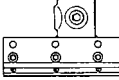
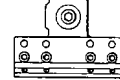
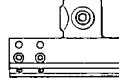
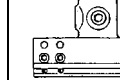
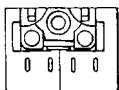
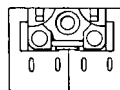
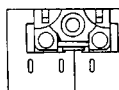
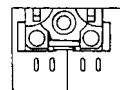
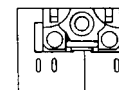
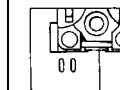
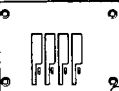
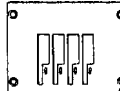
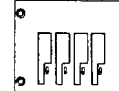
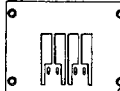
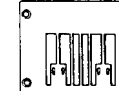
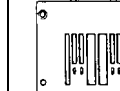

* For changing the gauge, the looper holder nut (S12840-001) and bolt, socket M3 × 12 (018301-222) are required in the same quantity as the looper holder.

Gauge parts list

Specifications	000-8	000-9	001-0	001-1	020-1	020-2
Label	S12808-046	S12808-047	S12808-048	S12808-049	S12808-006	S12808-007
Application	For plain stitching				For elastic gathered waistbands	
Needle spacing (inch)						
Name of parts	G	H	J	K	L	A
Needle clamp assy	S13406-001 	S13598-001 	S14261-001 	S14263-001 	S16041-001 	S13400-001 
Presser foot assy	S12789-001 	S13601-001 	S14270-001 	S14273-001 	S16044-001 	S12767-001 
Needle plate	S12766-001 	S13600-001 	S14267-001 	S14268-001 	S16043-001 	S12760-001 
Feed dog	S12798-001 	S13604-001 	S14279-001 	S14280-001 	S16047-001 	S12792-001 
Retainer holder assy	S13413-001 	S13605-001 	S14282-001 	S14284-001 	S16048-001 	S13407-001 
Looper holder *	S12839-001 (4 piece)	S12839-001 (4 piece)	S13814-001 (2 piece)	S13814-001 (2 piece)	S12839-001 (4 piece)	S12839-001 (4 piece)
Needle size Schmetz (Organ)	#75 - #100 (#11 - #18)	#75 - #100 (#11 - #18)	#75 - #100 (#11 - #18)	#75 - #100 (#11 - #18)	#75 - #100 (#11 - #18)	#75 - #100 (#11 - #18)

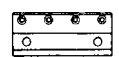
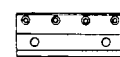

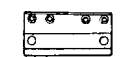
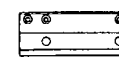
* For changing the gauge, the looper holder nut (S12840-001) and bolt, socket M3 × 12 (018301-222) are required in the same quantity as the looper holder.

Gauge parts list

Specifications	020-3	020-4	020-5	020-9	040-6	040-7
Label	S12808-008	S12808-009	S12808-010	S12808-033	S12808-011	S12808-012
Application	For elastic gathered waistbands				For shirtfronts	
Needle spacing (inch)						
Name of parts	B	C	D	H	E	F
Needle clamp assy	S13401-001 	S13402-001 	S13403-001 	S13598-001 	S13404-001 	S13405-001 
Presser foot assy	S12774-001 	S12777-001 	S12780-001 	S13601-001 	S12783-001 	S12786-001 
Needle plate	S12761-001 	S12762-001 	S12763-001 	S13600-001 	S12764-001 	S12765-001 
Feed dog	S12793-001 	S12794-001 	S12795-001 	S13604-001 	S12796-001 	S12797-001 
Retainer holder assy	S13408-001 	S13409-001 	S13410-001 	S13605-001 	S13411-001 	S13412-001 
Looper holder *	S12839-001 (4 piece)	S12839-001 (4 piece)	S12839-001 (4 piece)	S12839-001 (4 piece)	S12839-001 (4 piece)	S13814-001 (2 piece)
Needle size Schmetz (Organ)	#75 - #100 (#11 - #18)	#75 - #100 (#11 - #18)	#75 - #100 (#11 - #18)	#75 - #100 (#11 - #18)	#75 - #100 (#11 - #18)	#75 - #100 (#11 - #18)



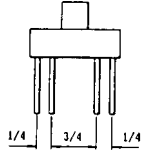
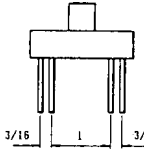
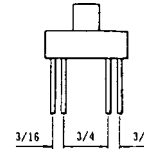
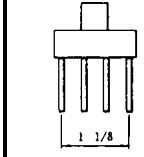
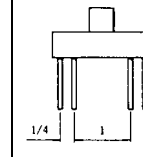
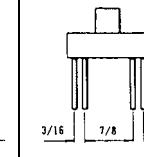
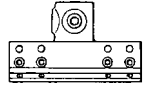
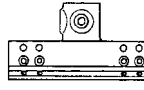
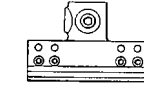
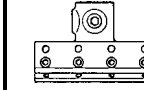
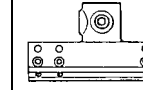
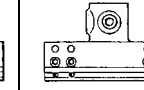
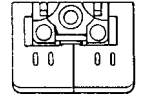
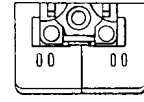
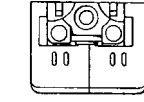
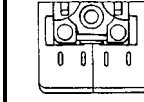
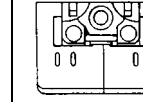
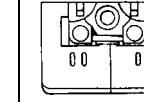
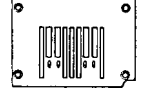
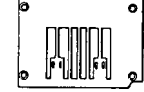
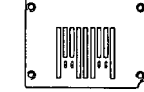
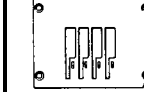
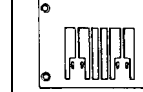
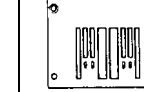
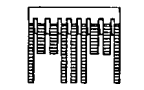
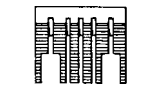
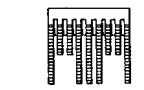
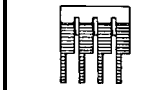
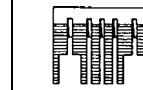
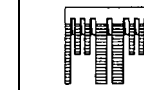

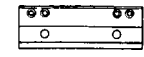
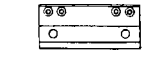
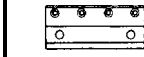
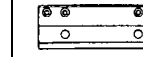
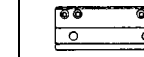

* For changing the gauge, the looper holder nut (S12840-001) and bolt, socket M3 × 12 (018301-222) are required in the same quantity as the looper holder.

Gauge parts list

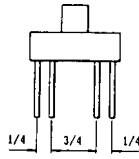
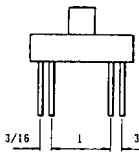
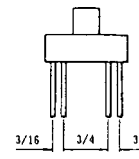
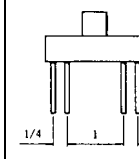
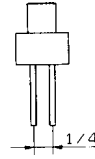
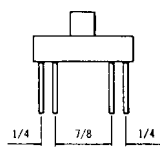
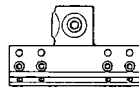
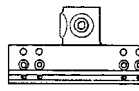
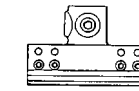
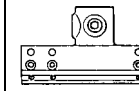
Specifications	040-8	041-0	041-1	050-3	050-6	050-7
Label	S12808-013	S12808-014	S12808-015	S12808-023	S12808-016	S12808-017
Application	For shirtfronts			For waistbands of jeans		
Needle spacing (inch)						
Name of parts	G	J	K	B	E	F
Needle clamp assy	S13406-001 	S14261-001 	S14263-001 	S13401-001 	S13404-001 	S13405-001 
Presser foot assy	S12789-001 	S14270-001 	S14273-001 	S12774-001 	S12783-001 	S12786-001 
Needle plate	S12766-001 	S14267-001 	S14268-001 	S12761-001 	S12764-001 	S12765-001 
Feed dog	S12798-001 	S14279-001 	S14280-001 	S12793-001 	S12796-001 	S12797-001 
Retainer holder assy	S13413-001 	S14282-001 	S14284-001 	S13408-001 	S13411-001 	S13412-001 
Looper holder *	S12839-001 (4 piece)	S13814-001 (2 piece)	S13814-001 (2 piece)	S12839-001 (4 piece)	S12839-001 (4 piece)	S13814-001 (2 piece)
Needle size Schmetz (Organ)	#75 - #100 (#11 - #18)	#75 - #100 (#11 - #18)	#75 - #100 (#11 - #18)	#75 - #100 (#11 - #18)	#75 - #100 (#11 - #18)	#75 - #100 (#11 - #18)

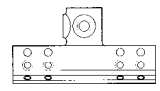
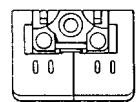
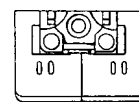
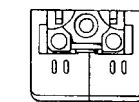
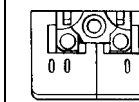
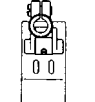
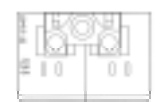
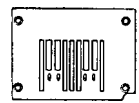
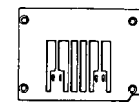
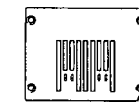
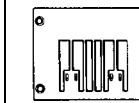
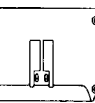
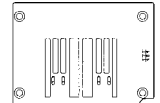
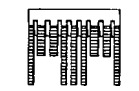
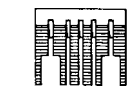
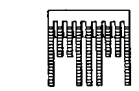
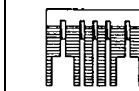
* For changing the gauge, the looper holder nut (S12840-001) and bolt, socket M3 × 12 (018301-222) are required in the same quantity as the looper holder.

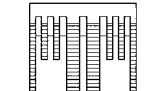
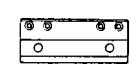
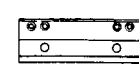
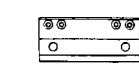
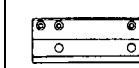
Gauge parts list

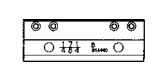
Specifications	050-8	051-0	051-1	060-6	Option	Option
Label	S12808-018	S12808-019	S12808-020	S12808-050	-	-
Application	For waistbands of jeans			(For heavy)	For plain stitching of twin needle machine (for heavy)	-
Needle spacing (inch)						
Name of parts	G	J	K	E, EH	N, L	M, F
Needle clamp assy	S13406-001 	S14261-001 	S14263-001 	S13404-001(E) 	S28879-001(N) 	S18435-001(M) 
Presser foot assy	S12789-001 	S14270-001 	S14273-001 	S28872-001 (EH) 	S28882-001(N) 	S18437-001(M) 
Needle plate	S12766-001 	S14267-001 	S14268-001 	S28871-001 (EH) 	S28881-001(N) 	S18436-001(M) 
Feed dog	S12798-001 	S14279-001 	S14280-001 	S12796-001(E) 	S28884-001(N) 	S12797-001(F) 
Retainer holder assy	S13413-001 	S14282-001 	S14284-001 	S13411-001(E) 	S16048-001(L) 	S18440-001(M) 
Looper holder *	S12839-001 (4 piece)	S13814-001 (2 piece)	S13814-001 (2 piece)	S12839-001 (4 piece)	S12839-001 (4 piece)	S12839-001 (4 piece)
Needle size Schmetz (Organ)	#75 - #100 (#11 - #18)	#75 - #100 (#11 - #18)	#75 - #100 (#11 - #18)	#120 - #140 (#19 - #22)	#100 - #130 (#16 - #21)	#75 - #100 (#11 - #18)

* For changing the gauge, the looper holder nut (S12840-001) and bolt, socket M3 × 12 (018301-222) are required in the same quantity as the looper holder.

Needle hole size of Needle plate

Needle plate	Needle hole size
EH (S28871-001)	2.0 mm
N (S28881-001)	1.8 mm
Others	1.6 mm