

DB2-B773 · B774

DB2-B7740 · B7741

Single Needle Adjustable Top and Bottom
Feed Lock Stitcher

Single Needle Adjustable Top and Bottom
Feed Lock Stitcher
with Thread Trimmer

Single Needle Adjustable Top and Bottom
Feed Lock Stitcher

with Thread Trimmer and Ply Sensor

Single Needle Adjustable Top and Bottom Feed Lock Stitcher
with Thread Trimmer and Programmable Shirring Device



Specifications

Model	DB2-B773 · B774 · B7740 · B7741	
Subclass	- □□3	- □□6
Use	Thin · medium heavy materials	
Sewing speed	4,500 rpm	
Max. stitch length	5.0 mm	
Feed method	Top & bottom feed	
Height of presser foot	Knee : 13 mm Manual : 6 mm Automatic : 8 mm	
Needle bar stroke	31.0 mm	
Thread take-up stroke	57.4 mm	
Height of feed dog	0.8 mm	
Max. upper feed amount	6.0 mm	8.0 mm
Intermediate gathering	-	○
Needle	DB × 1 #11	

	Thread trimmer	Ply sensor	Programmable shirring device	Application
B773	-	-	-	Men's wear: seaming sleeves, attaching facings, sewing up whole linings, seaming back centers, seaming backs, lining centers, seaming side, matching shoulders Slacks: seaming sleeves, matching shoulders, attaching fasteners, seaming sides, attaching and seaming sleeves, rolled-hemming linings, attaching yokes, attaching cuffs, joining waists
B774	○	-	-	Leather jumper: seaming necks, attaching facing at back centers, lining jeresy fonts, lining jeresy rounds Ski anorak: sewing inside cotton for front & back shirts, front & back shirts, sides, necks, outer & inner sleeves and front & back bodies, attaching fasteners
B7740	○	○	-	Same applications as B773 and B774. Especially attaching pockets, stitching collars.
B7741	○	-	○	Same applications as B773 and B774. Especially attaching sleeves (easing).

DB2-B773-00

Gathering	
3	– (Standard)
6	○ (Gathering type)

DB2-B774-0

Function				
	Thread trimmer	Thread wiper	Quick back	Automatic presser foot lifter
3	○	–	○	–
4	○	○	○	–
9	○	○	○	○ (Solenoid)

Shirring	
3	– (Standard)
6	○ (Shirring type)

DB2-B7740-2

Function				
	Thread trimmer	Thread wiper	Quick back	Automatic presser foot lifter
4	○	○	○	–
9	○	○	○	○ (Solenoid)

Shirring device	
3	– (Standard)
6	○ (Shirring type)

DB2-B7741-46

Function				
	Thread trimmer	Thread wiper	Quick back	Automatic presser foot lifter
4	○	○	○	–
9	○	○	○	○ (Solenoid)

Feed guide device

[DB2-B773, B774]

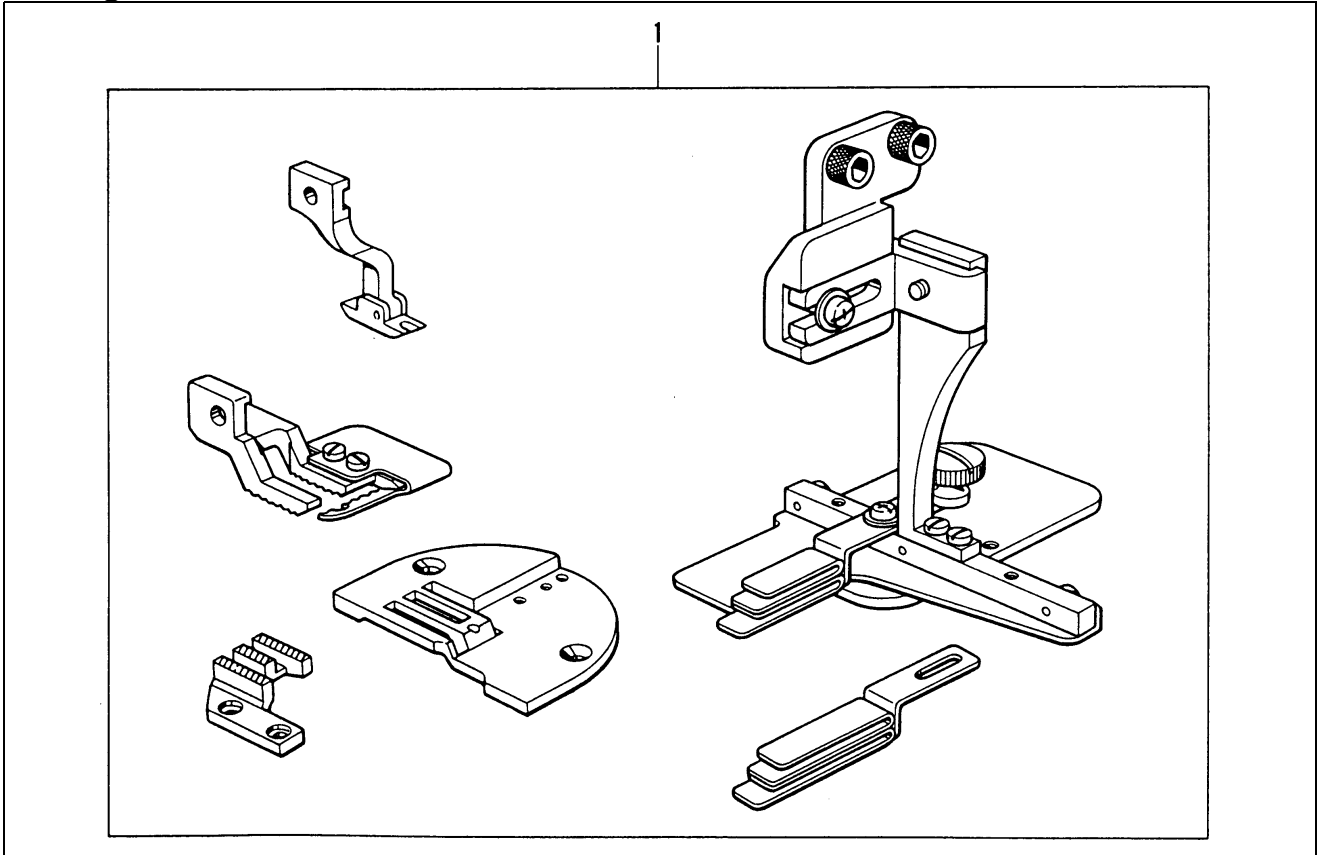

Ref. No.	Part name	Part code	Q'ty
1	FG guide assy	S16125-001	1

Feed guide base device

[DB2-B773, B774]

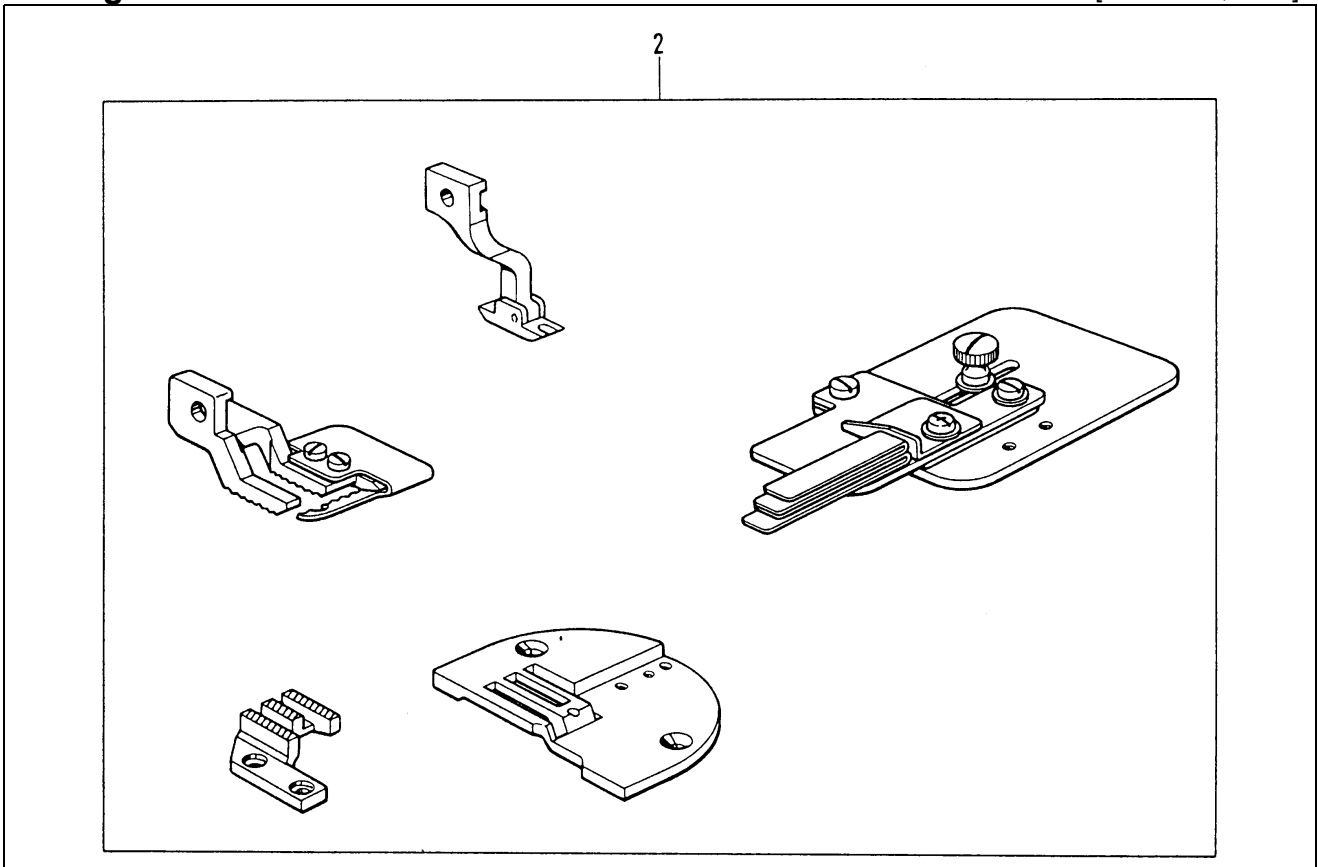

Ref. No.	Part name	Part code	Q'ty
2	FG guide base assy	S16126-001	1

3

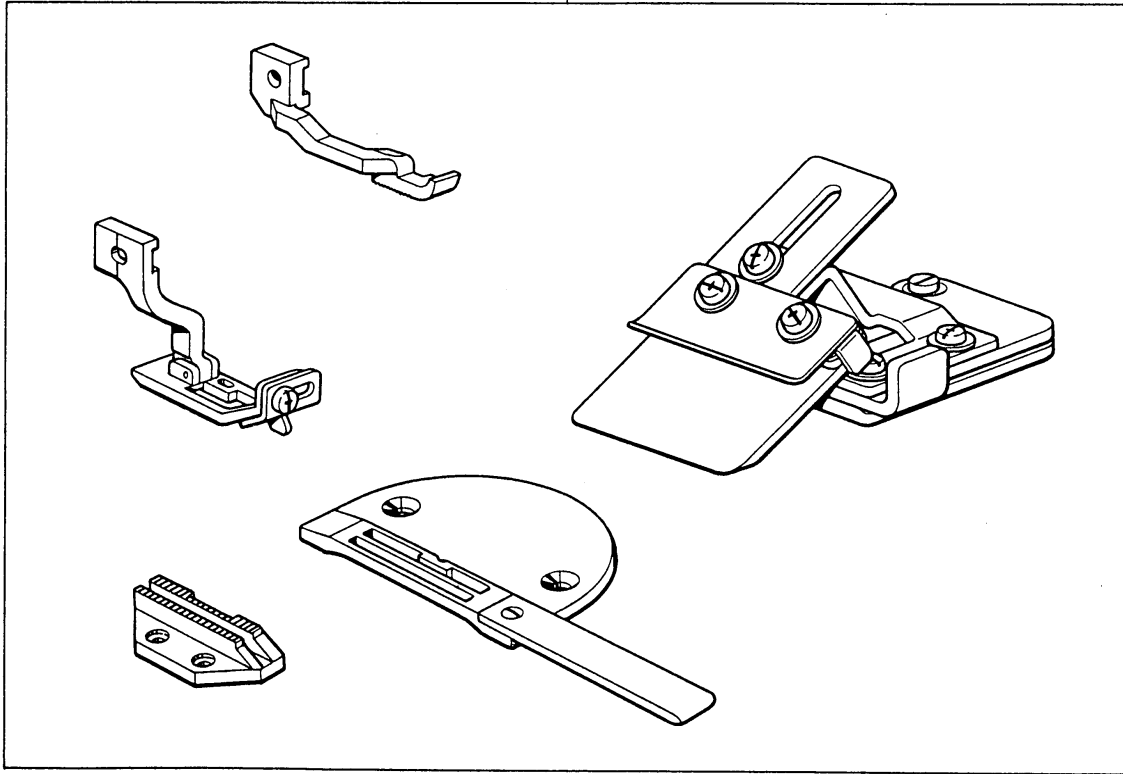

Ref. No.	Part name	Part code	Q'ty
3	WB device assy	183553-001	1

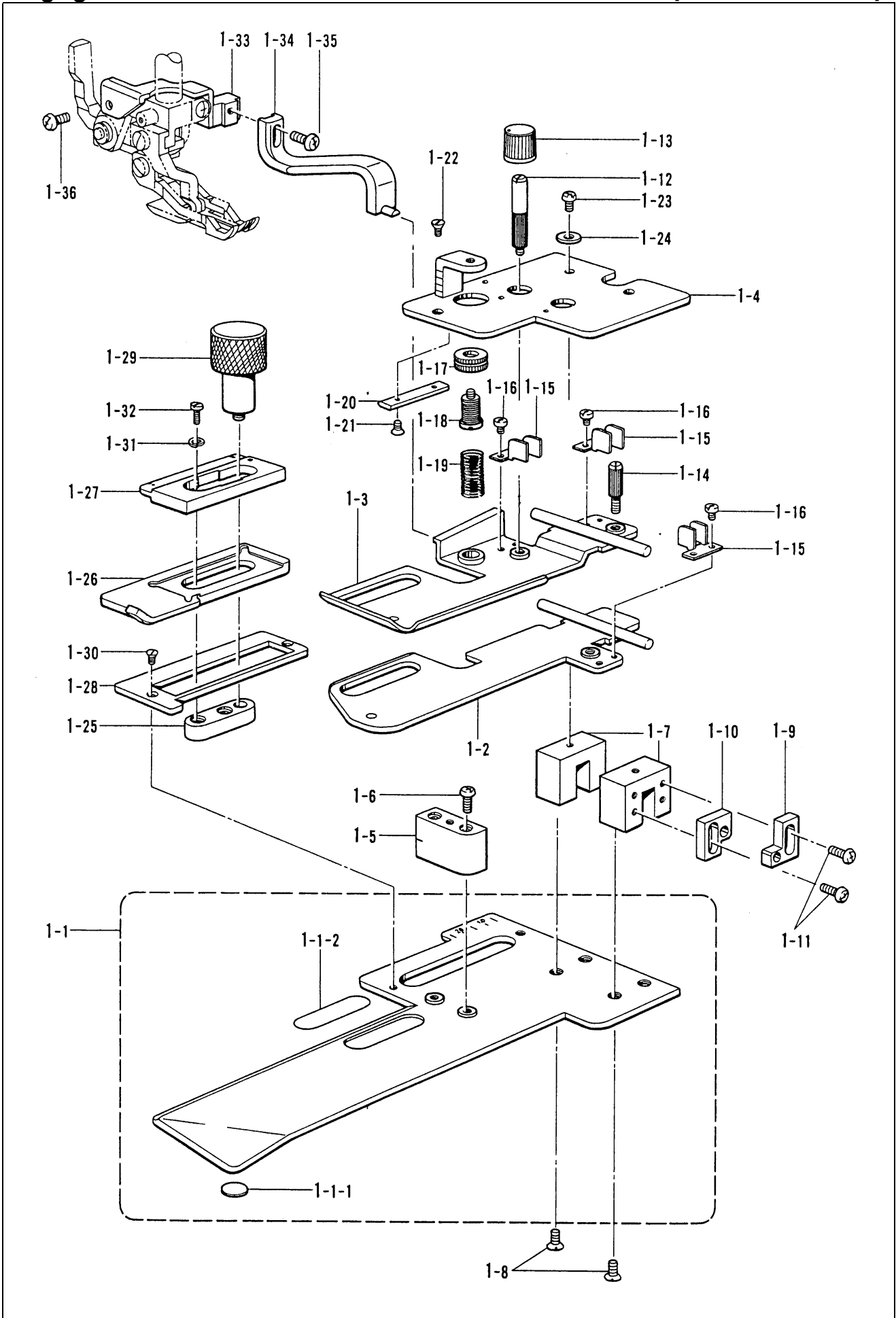



Edge guide device

[DB2-B774, B7740, B7741]

Ref. No.	Part name	Part code	Q'ty
1	Edge guider set	S16040-009	1
1-1	Guide base assy	154635-001	1
1-1-1	Rubber cushion	154637-000	3
1-1-2	Reflection plate	154638-000	1
1-2	Guide plate lower	154639-001	1
1-3	Guide plate upper	154640-001	1
1-4	Guide cover	154641-009	1
1-5	Guide block	154642-001	1
1-6	Screw, pan M3.57 – 40 × 10	062671-012	2
1-7	Bearing support	154643-001	2
1-8	Screw, flat M3.57	102843-001	4
1-9	Guide bearing (R)	102843-004	2
1-10	Guide bearing (L)	154644-001	2
1-11	Screw, pan M3.57 – 40 × 7	154645-001	8
1-12	Space screw	062670-712	2
1-13	Knob	154646-001	2
1-14	Closing screw	154647-000	1
1-15	Spring	154648-001	3
1-16	Screw 2.38	154649-001	6
1-17	Adjust screw	122771-001	1
1-18	Point adjust shaft	154650-001	1
1-19	Spring	154651-001	1
1-20	Lever guide	156453-000	1
1-21	Screw, flat M2.38	100191-005	2
1-22	Screw, flat M3.57	102843-004	1
1-23	Screw, pan M3.57 – 40 × 5	062670-512	2
1-24	Washer, plain S3.5	025350-132	2
1-25	Guide bracket	154654001	1
1-26	Auxiliary upper plate	154655-000	1
1-27	Upper plate collar	154656-001	1
1-28	Spacer	154657-001	1
1-29	Screw	154623-001	1
1-30	Screw, flat M2.38	100191-005	2
1-31	Washer, spring 2 – 3.5	028350-242	2
1-32	Screw, pan M3.57 – 40 × 7	062670-712	2
1-33	Closing lever supporter	S15904-001	1
1-34	Closing lever	S15905-001	1
1-35	Screw, pan M3.57 – 40 × 8	062670-812	1
1-36	Screw, pan M3.57 – 40 × 4	062670-412	1

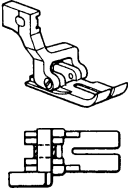
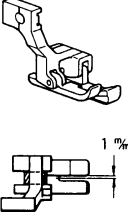

Gauge parts list For topstitching

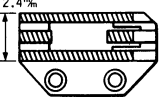
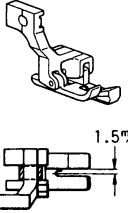
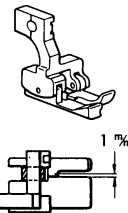
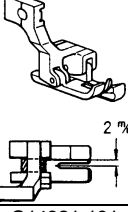
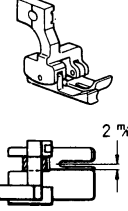
[DB2-B773, B774, B7740, B7741]

Gauge type	Presser foot assy	Upper feed dog	Needle plate	Feed dog	Use
A 183558-101	151277-201 Free presser foot 	S13256-001	159288-201	159301-001	Men's and lady's wear etc., stitching sleeve caps, basting under sleeves, seaming back center, joining shoulders, sewing sides
AC1 183579-101	159447-201 Free presser foot 	Oblique type teeth 	$\phi 1.6$ 	Oblique type teeth P1.15 	Dress, shirt, blouse etc., topstitching edge, sewing pocket (1mm right compensating foot)
AC1.5 183615-101	S13745-101 Free presser foot 				Dress, shirt, blouse etc., topstitching edge, sewing pocket (1.5mm right compensating foot)
ACL1 183587-101	S14317-101 Free presser foot 				Dress, shirt, blouse etc., topstitching edge, sewing pocket (1mm left compensating foot)
AC2 183580-101	S01041-201 Free presser foot 				Dress, shirt, blouse etc., topstitching edge, sewing pocket (2mm right compensating foot)
ACL2 183588-101	S14321-101 Free presser foot 				Dress, shirt, blouse etc., topstitching edge, sewing pocket (2mm left compensating foot)



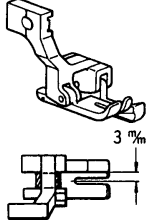
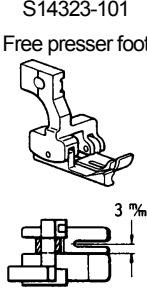
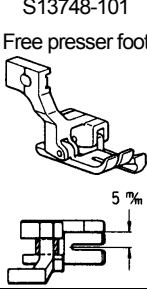
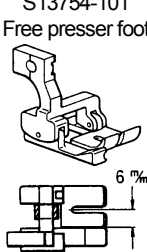

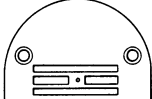
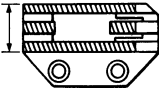
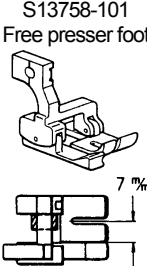
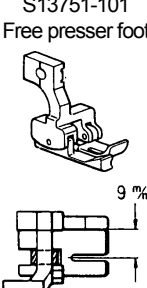
For topstitching

[DB2-B773, B774, B7740, B7741]

Gauge type		Presser foot assy	Upper feed dog	Needle plate	Feed dog	Use
AC3	183581-101	S01044-201 Free presser foot  3 mm	S13256-001	159288-201	159301-001	Dress, shirt, blouse etc., topstitching edge, sewing pocket (3mm right compensating foot)
ACL3	183589-101	S14323-101 Free presser foot  3 mm				Dress, shirt, blouse etc., topstitching edge, sewing pocket (1mm left compensating foot)
AC5	183616-101	S13748-101 Free presser foot  5 mm				Dress, shirt, blouse etc., topstitching edge, sewing pocket (5mm right compensating foot)
ACL6	183617-101	S13754-101 Free presser foot  6 mm	Oblique type teeth 	$\phi 1.6$ 	Oblique type teeth P1.15 12.4 mm 	Dress, shirt, blouse etc., topstitching edge, sewing pocket (6mm left compensating foot)
ACL7	183618-101	S13758-101 Free presser foot  7 mm				Dress, shirt, blouse etc., topstitching edge, sewing pocket (7mm right compensating foot)
AC9	183619-101	S13751-101 Free presser foot  9 mm				Dress, shirt, blouse etc., topstitching edge, sewing pocket (9mm left compensating foot)

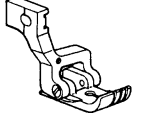
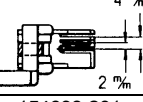
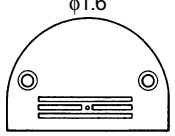
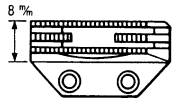
For topstitching

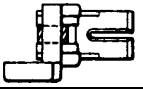
[DB2-B773, B774, B7740, B7741]

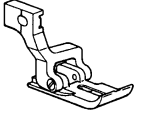
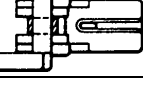
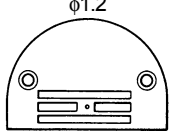
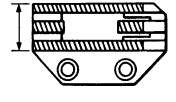
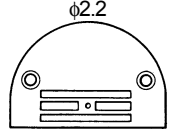
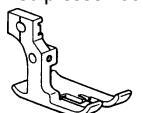
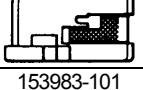
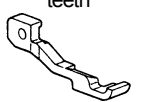
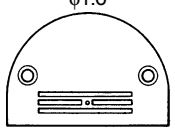
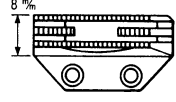
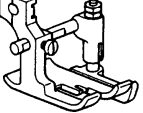
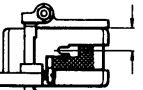
Gauge type	Presser foot assy	Upper feed dog	Needle plate	Feed dog	Use
AM	159421-201 Free presser foot  	S13256-001	159295-201 	159305-001 Parallel type teeth P1.15 	Dress, shirt, knitshirt ect., sewing pocket, sword polo-stitching, topstitching front
AS	183573-101 154698-201 Free presser foot  	Oblique type teeth 			
AT	183572-101 154445-201 Free presser foot  		159289-001 	159301-001 Oblique type teeth P1.15 	Lady's wear etc., stitching sleeve caps of face and lining cloth, seaming back center, joining shoulder, sewing sides
A22		Whole A type	S13781-201 		The needle plate has a bigger needle hole for thick materials
F	183563-001 151292-201 Fixed presser foot  	S13260-001 Cross-shaped type teeth 	159295-201 	159305-001 Parallel type teeth P1.15 	Collared shirt etc., topstitching neck, stitching cuffs, side · pucker type
FD	183570-001 153983-101 Fixed presser foot  				Collared shirt etc., topstitching neck, stitching cuffs, side · pucker type (max. stitch width 12mm) "FD" is "F" the thickness presser (183066-001) to "F"

For topstitching

[DB2-B773, B774, B7740, B7741]

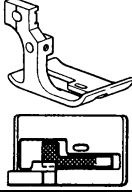
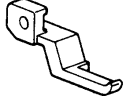
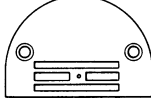
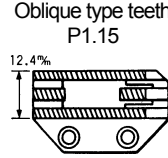
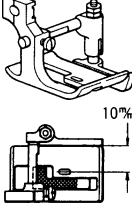
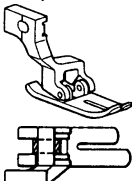
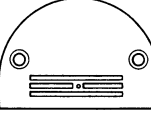
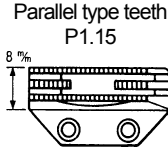
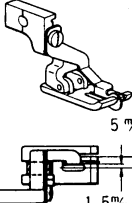
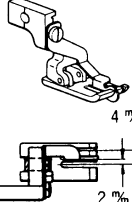
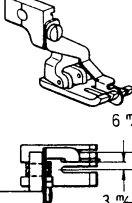
Gauge type		Presser foot assy	Upper feed dog	Needle plate	Feed dog	Use
J	183566-001	151622-201 Fixed presser foot 	S13264-001 	159288-201 	159301-001 	Collared shirt etc., stitching neck, stitching cuffs, side · stretching type
JD	183571-001	153984-201 Fixed presser foot 				Collared shirt etc., stitching neck, stitching cuffs, side · stretching type (Max. stitch width 12 mm) "JD" is "J" with the thickness presser (183066-001).
S	183578-101	★159443-201 Standard (-3) Free presser foot 	★S13256-001 Standard (-3)	★159295-201 Standard (-3) 	★159305-001 Standard (-3) 	Shirt, blouse, etc., for small sharp turns.
SG1.5	183620-101	S13761-001 Free presser foot 		159292-101	S15074-001	Shirt, blouse, dress, jacket etc. Topstitching edge (with stitch guide spring 1.5mm)
SG2	183621-101	S13765-001 Free presser foot 				Skirt, slacks, topstitching belt etc., various stitching (stitch width 2mm)
SG3	183622-101	S13771-001 Free presser foot 				Skirt, slacks, various stitching (with stitch guide spring 3mm)

For topstitching

[DB2-B773, B774, B7740, B7741]

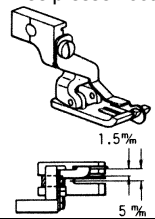
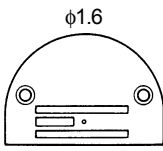
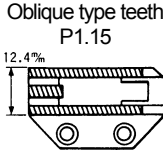
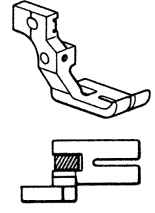
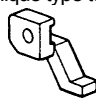
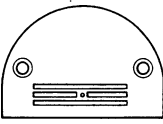
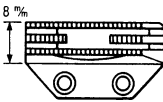
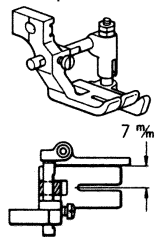
Gauge type		Presser foot assy	Upper feed dog	Needle plate	Feed dog	Use
SG5	183623-101	S13769-001 Free presser foot 	S13256-001	159292-101 $\phi 1.6$ 	S15074-001 Oblique type teeth P1.15 	Skirt, slacks, topstitching belt etc., various stitching (stitch width 5mm)
JD	183571-001	S07671-101 Fixed presser foot 	Oblique type teeth 	159295-201 $\phi 1.6$ 	159305-001 Parallel type teeth P1.15 	Men's and lady's wear etc., stitching sleeve caps, basting under sleeve, seaming back center, joining shoulder, sewing sides
S	183578-101	S07670-101 Fixed presser foot 				Men's and lady's wear etc., stitching sleeve caps, basting under sleeve, seaming back center, joining shoulder, sewing sides "SSD" is SS with the thickness presser (183066-001).

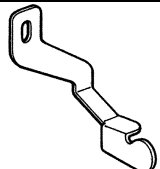
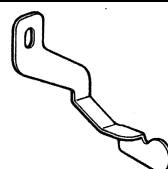
SG1.5 · 2 · 3 mm Guide plate S13768-001	SG4 · 5 · 6 mm Guide plate S13770-001
	

For gathering

[DB2-B773, B774, B7740, B7741]

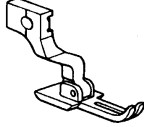
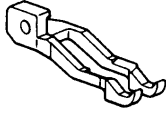
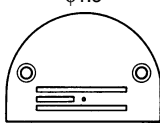
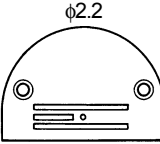
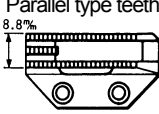
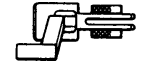
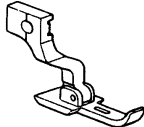
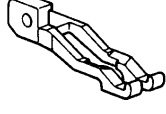
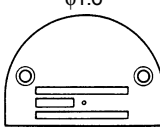
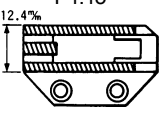
Gauge type	Presser foot assy	Upper feed dog	Needle plate	Feed dog	Use
B 183559-101	★151281-101 Standard (-6) Free presser foot 	★S13257-001 Standard (-6) Cross-shaped type teeth 	★S15094-001 Standard (-6) φ1.9  S13782-201 φ2.2 	★S15071-001 Standard (-6) Parallel type teeth 	Attaching yoke, attaching cuffs (gathering), basting front lining to facing (effect of uneven material feeding of different materials) Lady's and children's wear etc.
B22	Heavy materials 				The needle plate has a bigger needle hole for heavy materials.
L 183568-101	153575-101 Free presser foot 	S13268-001 Parallel type teeth 	159292-101 φ1.6 	S15074-001 Oblique type teeth P1.15 	Attaching yoke, Attaching cuffs (Gathering) Basting front lining to facing (Effect of uneven material feeding different materials) Lady's and children's wear etc.

Part name	Part code
Gathering separator assy	183627-001
Separator	S13369-001

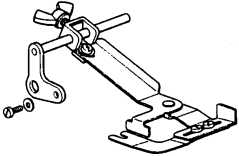

Part name	Part code
Separator S3 assy	183214-401
Separator	159321-101

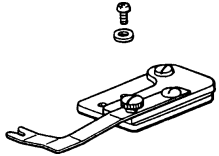

For rolled-hemming

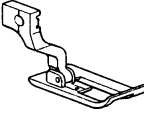
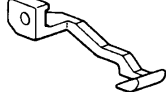
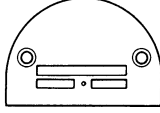
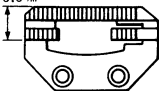
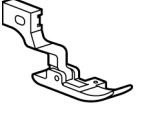
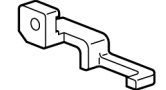
Gauge type	Presser foot assy	Upper feed dog	Needle plate	Feed dog	Use
E 183562-001	151290-101 Free presser foot 	S13259-001 Cross-shaped type teeth 	159294-001 φ1.6 	159304-001 Parallel type teeth P1.15 	Skirt, One-piece dress etc. For rolled-hemming
ED -	S49401-001 Free presser foot 	S49417-001 Parallel type teeth 			

For rolled-hemming

[DB2-B773, B774, B7740, B7741]

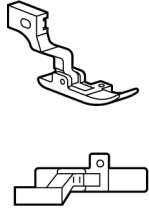
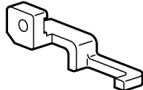
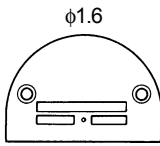
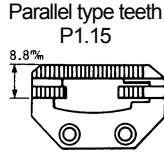
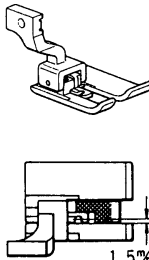
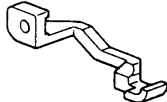
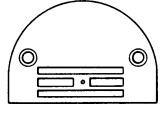
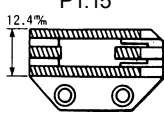
Gauge type	Presser foot assy	Upper feed dog	Needle plate	Feed dog	Use
EDA	- S56022-001 Free presser foot	S56024-001			
Exchange parts assy for medium materials		Parallel type teeth 	$\phi 1.6$ 	Parallel type teeth P1.15 	Skirt, One-piece dress etc. For rolled-hemming
N	183582-101	S01658-201	S13261-001	159288-201	159301-001
Exchange parts assy for medium materials	Free presser foot 	Cross-shaped type teeth 	$\phi 1.6$ 	Oblique type teeth P1.15 	Dress, Skirt, Coat, One-piece dress etc. For rolled-hemming (Stitch width 1.5 mm left compensating foot)





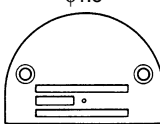
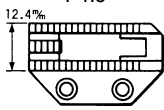
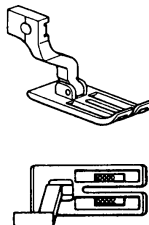
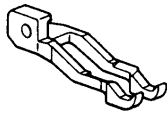
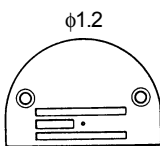
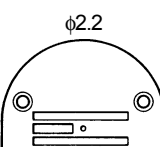
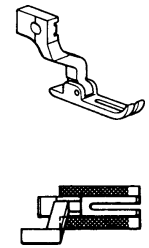
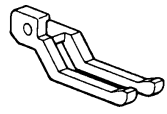
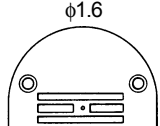
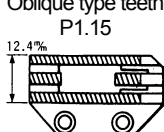



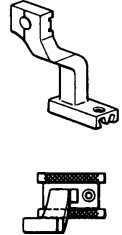
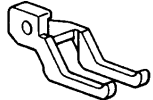
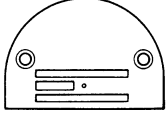
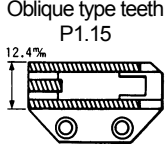

For difficult-to-feed materials

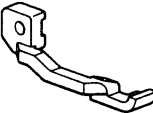
[DB2-B773, B774, B7740, B7741]

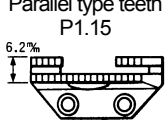
Gauge type	Presser foot assy	Upper feed dog	Needle plate	Feed dog	Use
C	183560-101	151286-101	S13257-001	159292-101	S15073-001
Exchange parts assy for medium materials			$\phi 1.6$ 	Parallel type teeth P1.6 	Seaming princess line, Stitching sleeve caps of double cloth sleeve, Topstitch pocket mouth, Lady's blazer, Men's slacks etc.
C12	Free presser foot 	Cross-shaped type teeth 	159293-101 $\phi 1.2$ 		
Medium materials			S13783-201 $\phi 2.2$ 		The needle plate has a bigger needle hole for heavy materials
C22	Heavy materials				
D	183561-001	151288-101	S13258-001	159288-201	159301-001
Exchange parts assy for thin and medium materials	Free presser foot 	Cross-shaped type teeth 	$\phi 1.6$ 	Oblique type teeth P1.15 	Ski suit, Leather jumper, Raincoat etc. Sewing under sleeve, Joining shoulder, Sewing sides, setting sleeves

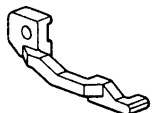
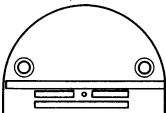
For sewing zipper (Exclusive right)

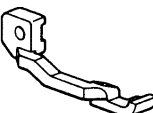
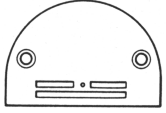
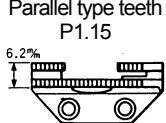
[DB2-B773, B774, B7740, B7741]

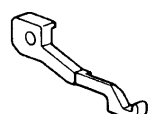
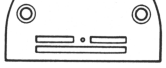

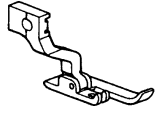
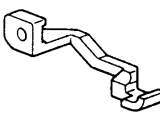
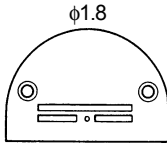
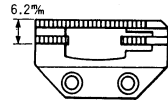
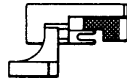
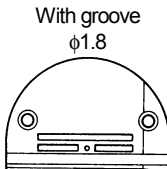
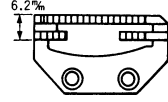
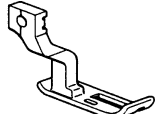
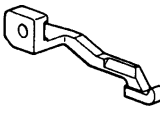
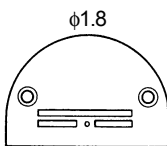
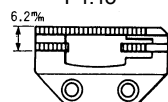
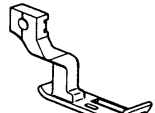
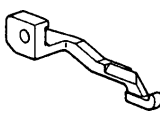
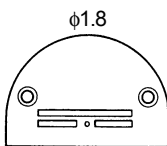
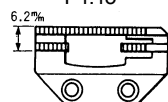

Gauge type		Presser foot assy	Upper feed dog	Needle plate	Feed dog	Use
GC	183625-101	S13777-001 Fixed presser foot 	S13778-001 Cross-shaped type teeth 	159292-101 $\phi 1.6$ 	S15074-001 Oblique type teeth P1.15 12.4% 	Skirt etc. For sewing conceal fastener
GRM	183576-001	151293-101 Free presser foot 	S13262-001 Cross-shaped type teeth 	159297-001 With groove $\phi 1.8$ 	156247-001 Parallel type teeth P1.15 6.2% 	One-piece dress, Skirt, Slacks etc. For sewing zipper
GS	183584-001	S04541-101 Free presser foot 	S13263-001 Cross-shaped type teeth 	S04540-001 With groove $\phi 1.8$ 	S00846-001	For prevent twisting One-piece dress, Dress, Skirt, Sportswear etc. For sewing zipper
GR	183564-001	151293-101 Free presser foot 	S13262-001 Cross-shaped type teeth 	159296-101 $\phi 1.8$ 	Parallel type teeth P1.15 6.2% 	Skirt, Jumper, One-piece dress, Slacks etc. For sewing zipper
KR	183577-001	156617-101 Fixed presser foot 	S13267-001 Cross-shaped type teeth 			Sportswear, Ski anorak, Leather jumper etc. For sewing zipper

For sewing zipper (Exclusive left)

[DB2-B773, B774, B7740, B7741]

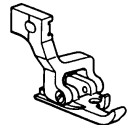

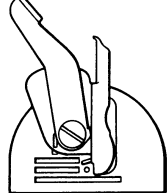
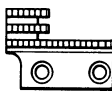
Gauge type	Presser foot assy	Upper feed dog	Needle plate	Feed dog	Use
GL 183565-001	151293-101 Free presser foot 	S13261-001 Cross-shaped type teeth 	159298-101 $\phi 1.8$ 	S00865-001 Parallel type teeth P1.15 	One-piece dress, Skirt etc. For sewing zipper
GLM 183591-001	Exchange parts assy for medium materials 	159299-001 With groove $\phi 1.8$ 	159306-001 Parallel type teeth P1.6 		
K 183567-001	153170-101 Fixed presser foot 	S13265-001 Free type teeth 	159298-101 $\phi 1.8$ 	S00865-001 Parallel type teeth P1.15 	Sportswear, Ski anorak, Leather jumper etc. For sewing zipper
KL7 183583-001	S01941-201 Fixed presser foot 	S13266-001 Cross-shaped type teeth 			School trousers etc. For sewing zipper

For binding

Gauge type	Presser foot assy	Upper feed dog	Needle plate	Feed dog	Use
H	151299-101 Free presser foot 	S13256-001 Oblique type teeth 	Goods on the market 	Goods on the market 	Dress, One-piece dress, Coat, Blazer, Best etc. For binding 

For binding

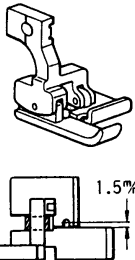

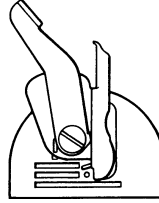
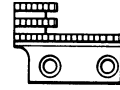
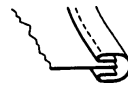
[DB2-B773, B774, B7740, B7741]

Gauge type	Presser foot assy	Upper feed dog	Needle plate	Feed dog	Use
HC	S14315-101	S13256-001			
Medium materials	Free presser foot  1.5mm	Oblique type teeth 	Goods on the market 	Goods on the market 	One-piece dress, Jacket, Best Dress etc. For binding 

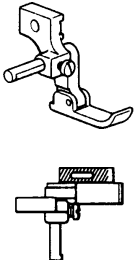
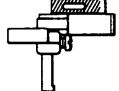
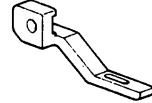
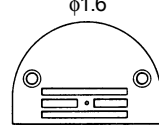
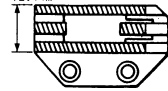

For restrain cloth from flapping

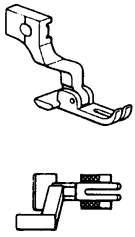
Gauge type	Presser foot assy	Upper feed dog	Needle plate	Feed dog	Use
M	183569-001	153978-101	S13269-001	159288-201	159301-001
Exchange parts assy for medium materials	Free presser foot  	Oblique type teeth 	$\phi 1.6$ 	Oblique type teeth P1.15 12.4% 	Skirt, One-piece dress, Jumper etc. For sewing zipper Stitching, Topstitching edge

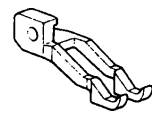
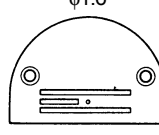
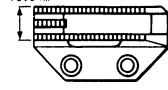
Effective type for puckering

Gauge type	Presser foot assy	Upper feed dog	Needle plate	Feed dog	Use
P	183585-101	S04550-101	S13270-001	S13398-001	S13364-001
Exchange parts assy for thin materials	Free presser foot  	Cross-shaped type teeth 	$\phi 1.6$ 	Parallel type teeth P1.15 10.6% 	Lady's wear, Flimsy dress, Blouse etc. This type possesses middle peculiarity of pucker and stretching

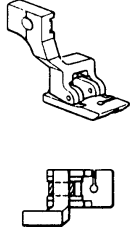

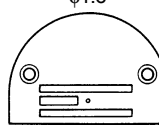
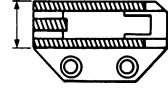
For piping

Gauge type	Presser foot assy	Upper feed dog	Needle plate	Feed dog	Use
SP	183624-101	S13774-001	S15093-001	159292-101	S15074-001
Exchange parts assy for thin and medium materials	Free presser foot  	Oblique type teeth 	$\phi 1.6$ 	Oblique type teeth P1.15 12.4% 	Dress, One-piece dress, Coat, Blazer etc. For piping

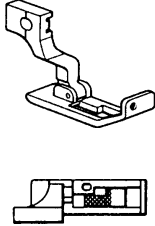
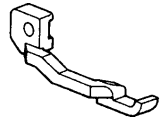
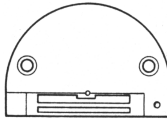
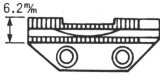
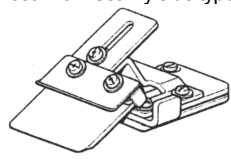
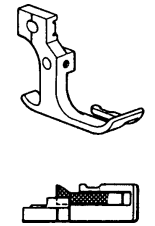
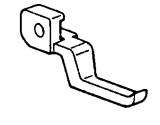
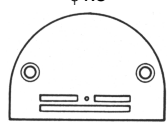
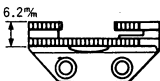

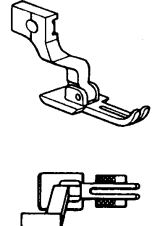
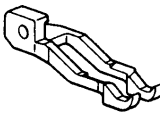
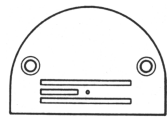
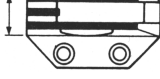
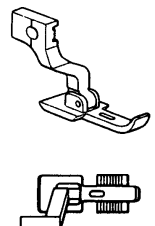
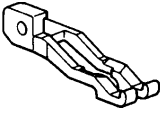
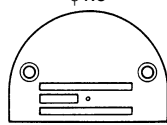

For concealed-seaming waist belt

Gauge type		Presser foot assy	Upper feed dog	Needle plate	Feed dog	Use
WB	183553-001	S01258-101 Free presser foot 	S13271-001 Cross-shaped type teeth 	S01256-001 $\phi 1.8$ 	S01261-001 Parallel type teeth P1.15 	Slacks, Skirt For concealed-seaming waist belt Conceal from seamy side type 
WJ	183626-001	S13779-001 Fixed presser foot 	S13780-001 Cross-shaped type teeth 	159296-101 $\phi 1.8$ 	S00864-001 Parallel type teeth P1.15 	This type is one, brought needle location close to inside belt

Special type

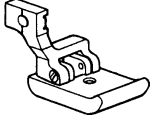
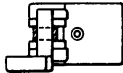
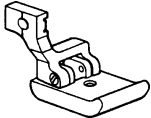
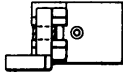
Gauge type		Presser foot assy	Upper feed dog	Needle plate	Feed dog	Use
BT	183574-101	151281-101 Free presser foot 	S13257-001 Cross-shaped type teeth 	159291-101 $\phi 1.2$ 	S15072-001 Rubber feed dog 	Quilt materials, Nylon, Taffeta, Lining cloth, Lady's thin materials etc. For prevent to make cloth cut, this type is added urethane to "S15071-001".
LT	183575-101	153575-101 Fixed presser foot 	S13268-001 Parallel type teeth 	159292-101 $\phi 1.6$ 	S15075-001 Rubber feed dog 	Quilt materials, Nylon, Taffeta, Lining cloth, Lady's thin materials etc. For prevent to make cloth cut, this type is added urethane to "S15074-001".

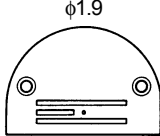
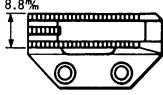
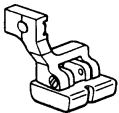
Special type

Gauge type	Presser foot assy	Upper feed dog	Needle plate	Feed dog	Use	
T 183586-201	S04554-201 Free presser foot  	S13256-001	S15094-001	S15071-001	Men's wear, Lady's wear etc. Stitching sleeve cap, Sewing under sleeve, Seaming under sleeve, Seaming back center, Joining shoulder, Effective for materials difficult to slide. Teflon presser	
TL	S07035-201 Free presser foot  	Oblique type teeth 	$\phi 1.9$ 	Parallel type teeth P1.15 		Topstitching edge, Transparent presser foot for piping
TP	S07196-201 Free presser foot  					Transparent presser foot for pin tack

For B7740, 25 mm sensor

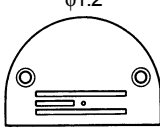
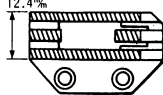
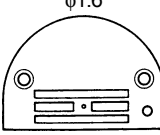
Gauge type	Presser foot assy	Upper feed dog	Needle plate	Feed dog	Use
A 12S	Whole A type		$\phi 1.2$ 	Oblique type teeth P1.15 	
A 16S			$\phi 1.6$ 		

For B7740, 25 mm sensor

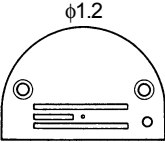
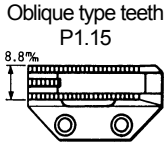
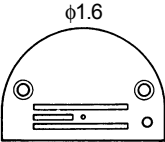
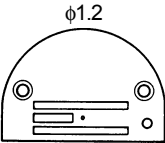
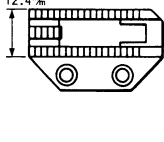
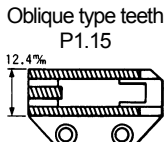
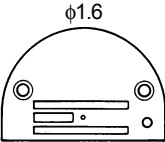
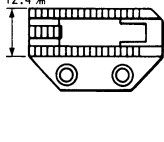
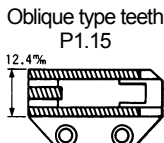
Gauge type	Presser foot assy	Upper feed dog	Needle plate	Feed dog	Use	
B 12S	Whole B, P type		S13359-101 	S15071-001 		
B 16S			S13358-101 			
C 12S	Whole C, SG type		S13361-101 	S15073-001 		
				S15074-001 		
C 16S			S13360-101 	S15073-001 		S15074-001 

For B7740, 25 mm sensor

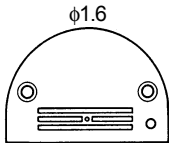
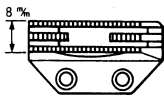
Gauge type	Presser foot assy	Upper feed dog	Needle plate	Feed dog	Use
F 16S	Whole F, S, SS type		S13362-201 	159305-001 Parallel type teeth P1.15 	

For B7740, 18 mm sensor (Please use it when stitch length is less than 4 mm)

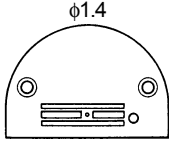
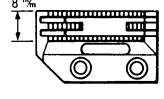
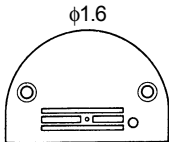
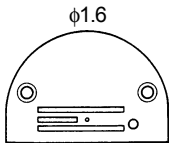
Gauge type	Presser foot assy	Upper feed dog	Needle plate	Feed dog	Use
AB 14T	Whole A, F, S type		S07037-001 	S13365-001 Parallel type teeth P1.15 	
AB 16T			S06654-001 		
P 16T	Whole B, P type		S13363-001 	S13364-001 Parallel type teeth P1.15 