

# BE-438B

## Electronic Lockstitch Button Sewer











### Specifications





Model	BE-438B Electronic lockstitch button sewer
Stitch formation	Single needle lock stitch
Max. sewing speed	2,500 rpm
Max. pattern size	0 – 6.4 x 0– 6.4 mm
Needle	TQ x 1 #12
Dimensions of buttons that can be sewn	Outer diameter of button 8 – 30 mm (Use the optional button clamp B for diameters of 20 mm or greater.) Space between the button holes 0– 6.4 mm
Button clamp height	Max. 13 mm
Thread knot	Knot tied by needle
Feed mechanism	R-θ intermittent feed mechanism (pulse-motor driven mechanism)
Stitch length	0.1 – 10.0 mm
No. of stitches	Variable (13, 15, 17, 19, 20, 22, 23, 24, 26, 27, 28, 30, 32, 34, 38 stitches pre-set)
Max. stitch number	20,000 stitches (including 10,000 stitches which can be added)
Work clamp lifter	Solenoid type
Hook	Shuttle hook
Wiper device	Standard equipment
Thread trimmer device	Standard equipment
Thread take-up device	Standard equipment
Data storage method	P-ROM (Any sewing pattern can be added using BAS-PC/300.)
No. of user programs	16
No. of cycle programs	4
No. of stored data	49 sewing patterns are set already. (Up to 100 patterns can be added. Total number of stitches of stored data which can be added is within 10,000.)
Motor	Three-phase 400W induction motor
Weights	Machine head: 52 kg, Operation panel: 0.6 kg, Control box: 9– 19 kg (depending on destination)
Power source	Single-phase 110V, 220– 230V, 3-phase 220V, 240V, 380V, 400V, Maximum electric power consumption; 600VA

## Program list

Sewing patterns are limited as shown in the table below.

(Any program is available as long as the needle drops down in the hole of the button.)

Program No.	No. of button holes	Sewing pattern	No. of threads	No. of crossover stitches	No. of stitches	Standard sewing length X	Standard sewing width Y
1	2		6	-	13	3.4 mm	0 mm
2			8	-	15		
3			10	-	17		
4			12	-	19		
5 *1			16	-	23		
6 *1			20	-	27		
7 *2	2		6	-	13	0 mm	3.4 mm
23 *2			10	-	17		
8 *2			12	-	19		
9 *2	3		5-5-5	-	22	2.6 mm	2.4 mm
24 *2			7-7-7	-	28		
25 *2			5-5-5	-	22		
26 *2			7-7-7	-	28		
10	4		6-6	1	20	3.4 mm	3.4 mm
11			8-8	1	24		
12			8-8	3	26		
13			10-10	1	28		
27			12-12	1	32		
14 *3			6-6	0	26		
28 *3			8-8	0	30		
15 *3			10-10	0	34		
29 *3			12-12	0	38		
16			6-5	1	19		
17			8-7	1	23		
30			10-9	1	27		
18			6-6	1	20		
19			8-8	1	24		
31			10-10	1	28		
45			12-12	1	32		

Program No.	No. of button holes	Sewing pattern	No. of threads	No. of crossover stitches	No. of stitches	Standard sewing length X	Standard sewing width Y
20 *3	4		6-6	0	26	3.4 mm	3.4 mm
32 *3			8-8	0	30		
33 *3			10-10	0	34		
21 *2			6-6	1	20	2.4 mm	3.4 mm
34 *2			10-10	1	28		
22 *2			6-6	0	26	3.4 mm	3.4 mm
35 *2			10-10	0	34		
46			6-6	1	20	3.4 mm	3.4 mm
47			8-8	1	24		
48			10-10	1	28		
49			12-12	1	32		



\*1. Check that the button hole diameter is 2mm or greater before using the programs.

\*2. Do not use the button lifter spring.

\*3. Thread is trimmed after sewing of one side is completed, because there is no crossover thread to be sewn.

To continue sewing to the end, keep the foot switch depressed until sewing of the other side starts, or press the foot switch once more after sewing of the first side is completed.

\*The following programs required the solenoid thread wiper (OP).

Program No.	No. of button holes	Sewing pattern	No. of threads	No. of crossover stitches	No. of stitches	Standard sewing length X	Standard sewing width Y
36	4		6-6	0	26	3.4 mm	3.4 mm
37			8-8	0	30		
38			10-10	0	34		
39			12-12	0	38		
40			6-6	0	26	3.4 mm	3.4 mm
41			8-8	0	30		
42			10-10	0	34		
43 *			6-6	0	26	2.4 mm	3.4 mm
44 *			10-10	0	34		

\*Do not use the button lifter spring.

**Optional device  
Solenoid thread wiper**

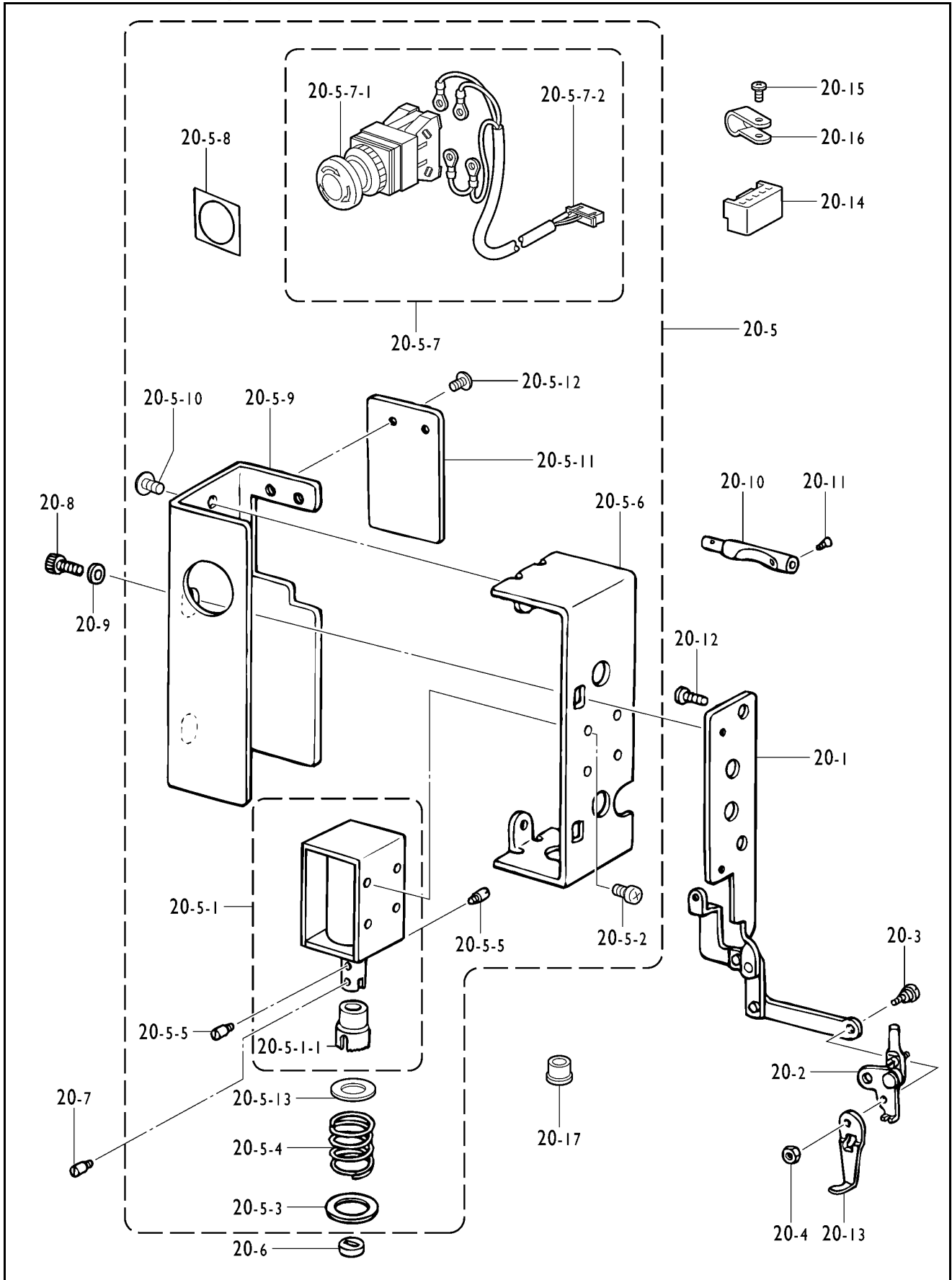

Ref. No.	Part name	Part code	Q'ty
20	Thread wiper solenoid assy	S49615-009	1
20-1	Connect rod assy, ; T-wiper	S41656-001	1
20-2	Thread wiper arm assy	S44600-001	1
20-3	Shoulder screw, SM3.57	153112-001	1
20-4	Nut, 2 SM3.57	021670-202	1
20-5	Solenoid box assy	S49616-009	1
20-5-1	Thread wiper solenoid assy	S49619-001	1
20-5-1-1	Plunger rubber	S41204-050	1
20-5-2	Screw, pan M3 x 6	062300-612	4
20-5-3	Washer, plain	S41205-001	1
20-5-4	Spring, T-wiper	S41206-001	1
20-5-5	Plunger pin	S25456-001	2
20-5-6	Setting plate, W-sol.	S42017-109	1
20-5-7	EM-lock switch harness assy	S49482-000	1
20-5-7-1	Switch, AVS311N	S32335-000	1
20-5-7-2	EM-switch harness	S49466-000	1
20-5-8	Spacer, 3 ; EM-switch	S37057-001	1
20-5-9	Solenoid cover, W	S42018-109	1
20-5-10	Screw, truss M4 x 6	008400-604	2
20-5-11	Solenoid cover lid, E	S37806-109	1
20-5-12	Screw, truss M4 x 6	008400-604	2
20-5-13	Washer, plain 13	115007-001	1
20-6	Spacer rubber	S41207-000	1
20-7	Plunger pin	S25456-001	1
20-8	Bolt, socket M4 x 6	018400-632	2
20-9	Washer	100645-003	2
20-10	Tension release rod, DW	S41657-001	1
20-11	Screw, flat M3.5 x 6	061350-616	1
20-12	Screw, pan SM4.37-40 x 8	062680-812	2
20-13	Thread wiper, A	156206-001	1
20-14	Connector, ; VHR-5N	S49947-000	1
20-15	Screw, bind SM3.57-40 x 6	060670-612	3
20-16	Cord holder, 7N	149287-000	3
20-17	Rubber cap, 15.5	104449-009	1

**Optional device  
Auxiliary device**

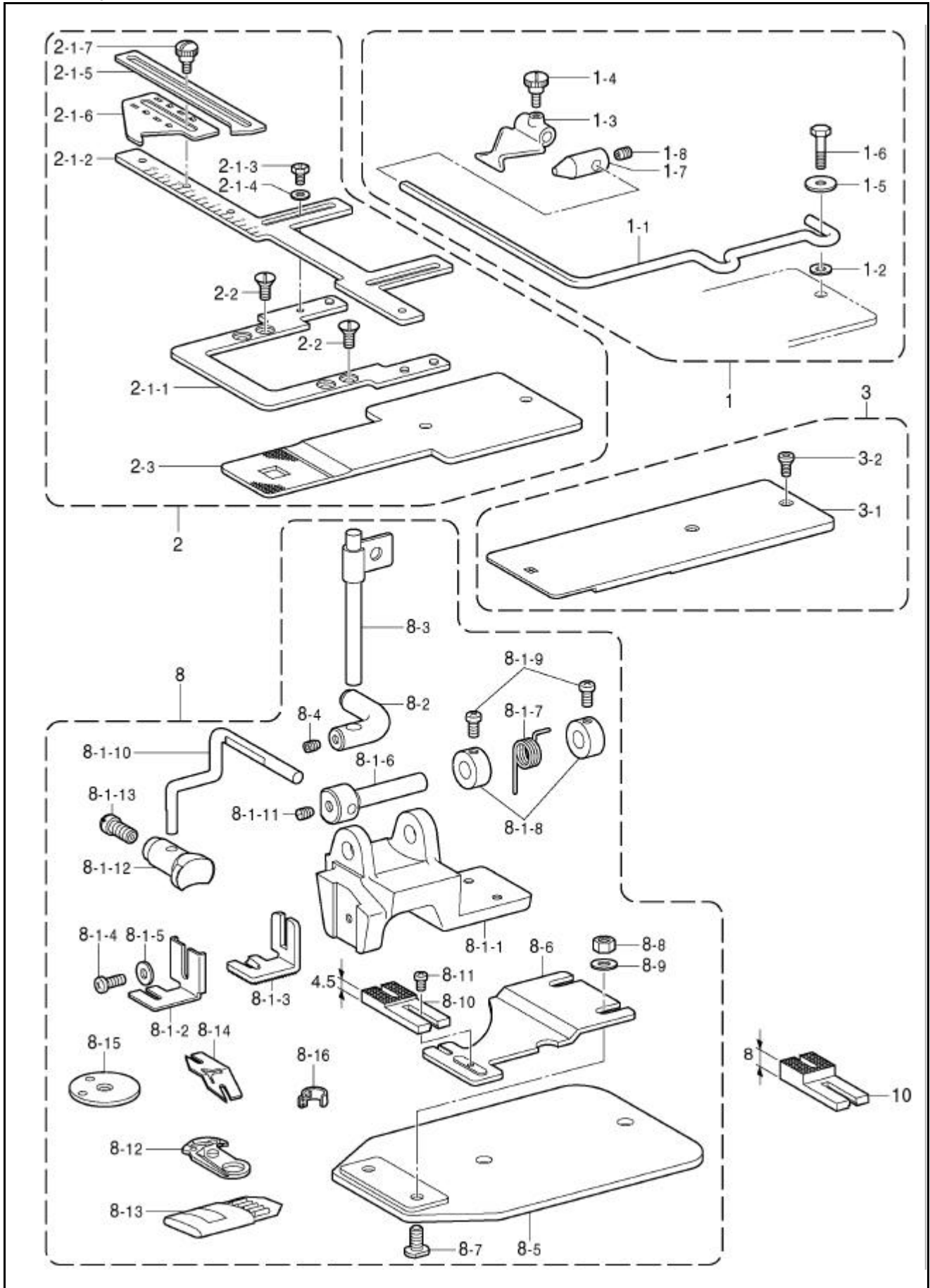

Ref. No.	Part name	Part code	Q'ty
1	Button spacer set	156440-001	1
1-1	Spacer rod	156441-001	1
1-2	Washer	122257-001	2
1-3	Spacer	156443-001	1
1-4	Screw, SM3.57	129984-003	1
1-5	Washer, plain	116662-004	2
1-6	Bolt, SM4.37	154835-001	2
1-7	Spacer, B	156342-001	1
1-8	Set screw, socket (CP) SM4.37	014680-422	1
2	Button spacer set, 438	S13183-101	1
2-1	Button spacer assy	S09662-101	1
2-1-1	Bracket	S09663-101	1
2-1-2	Scale	S09658-001	1
2-1-3	Bolt, SM4.37-40 x 7	S09686-001	1
2-1-4	Washer	S02745-001	1
2-1-5	Positioning setting plate, A	S09659-001	1
2-1-6	Positioning setting plate, B	S09660-001	1
2-1-7	Shoulder screw, SM4.37	115166-001	1
2-2	Screw, oval SM4.37 x 10	S01702-001	2
2-3	Feed plate for spacer	S13184-001	1
3	Gauge assy, 438E	S42902-001	1
3-1	H – position standard plate	S42903-001	1
3-2	Screw, w / socket SM4.37	S10352-101	2
8	Shank device set, 438E	S42098-009	1
8-1	Shank button clamp bracket assy	142689-309	1
8-1-1	Shank button clamp bracket	154684-009	1
8-1-2	Button clamp, A	142677-101	1
8-1-3	Button clamp, B	142678-101	1
8-1-4	Screw, pan SM3.57-40x 8	062670-812	1
8-1-5	Washer	102707-003	1
8-1-6	Button presser stud	142681-001	1
8-1-7	Spring	154685-001	1
8-1-8	Set screw collar	142706-001	2
8-1-9	Screw, pan SM3.57-40x 7	062670-712	2
8-1-10	Button presser arm	154686-001	1
8-1-11	Set screw, (CP) SM4.76	013719-412	1
8-1-12	Button presser	142680-001	1
8-1-13	Set screw, (CP) SM4.37-40x 8	120990-001	1
8-2	Button presser arm lifter	154695-001	1
8-3	Button presser arm lifter stud	154696-001	1
8-4	Set screw, socket (CP) SM4.37	014680-422	1
8-5	Feed plate base	154697-001	1
8-6	Feed plate, ;shank button	156336-101	1
8-7	Screw, SM4.76	154713-001	2
8-8	Nut, 2 SM4.76	021710-212	2
8-9	Washer, plain SM4.76	025710-232	2
8-10	Cloth receiver, S	142686-101	1
8-11	Screw, bind SM3.57-40 x 5	060705-512	1
8-12	Movable knife assy, LL	S41508-001	1
8-13	Needle assy, TQ x 7 (#16)	115040-116	1
8-14	Shuttle race thread guide	S41510-001	1
8-15	Needle hole plate, E	S10212-101	1
8-16	Thread guide, B ;Needle bar	S41222-101	1
10	Cloth receiver, M	142687-101	1

## Button clamp (20 mm or more)

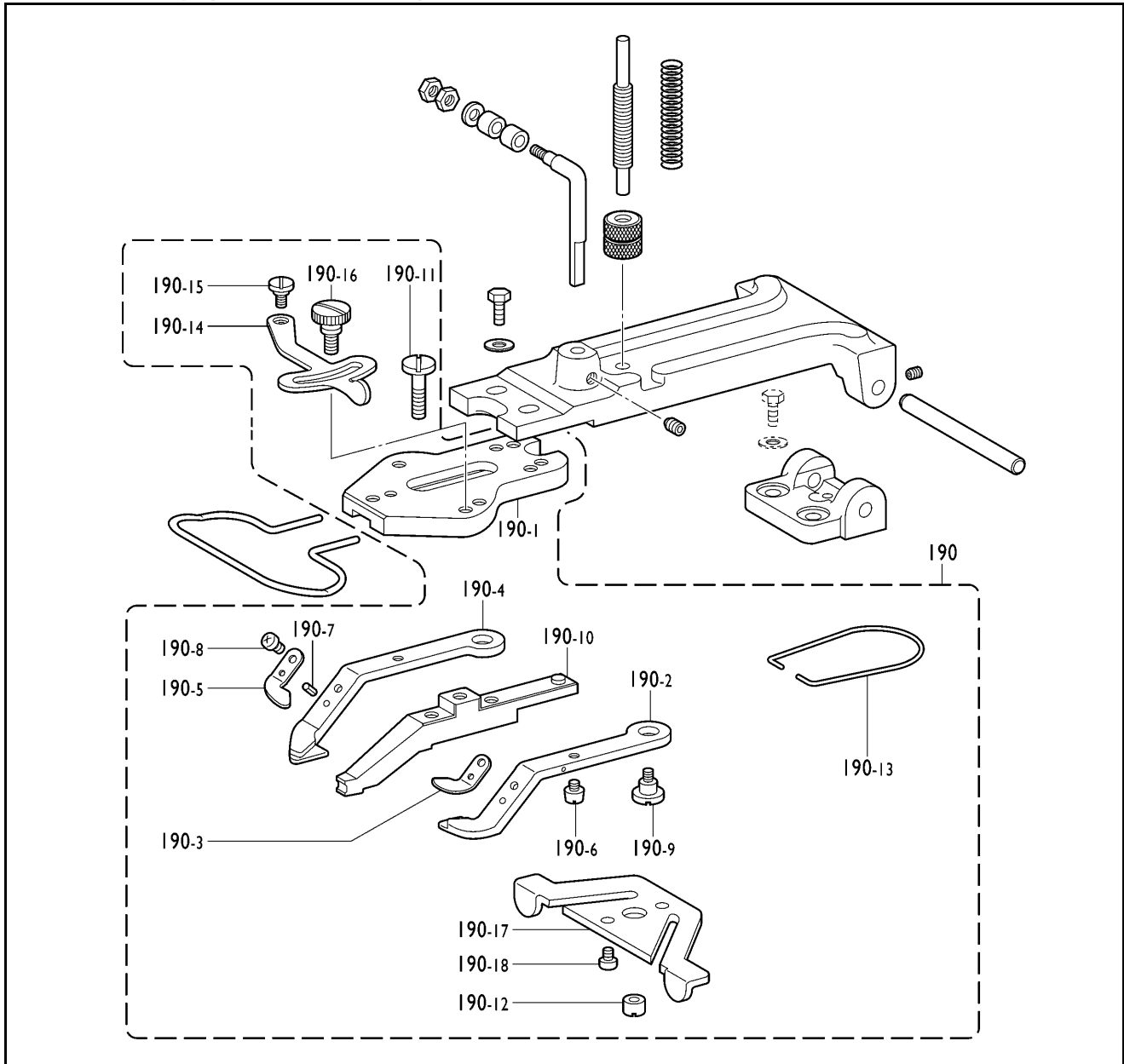



Ref. No.	Part name	Part code	Q'ty
190	Button clamp assy, B	S03634-001	1
190-1	Button clamp bracket	S03464-101	1
190-2	Button clamp, LB	S03650-001	1
190-3	Spring, plate ;L	S11079-001	1
190-4	Button clamp, RB	S03649-001	1
190-5	Spring, plate ;R	S11080-001	1
190-6	Pin	115156-001	2
190-7	Pin, spring roll AW2.5	047250-642	2
190-8	Screw, pan SM4.37 – 40 x 5	062680-512	2
190-9	Shoulder screw, SM4.76	115158-001	2
190-10	Button clamp assy, M	S03467-001	1
190-11	Screw, M4.37	S03468-001	1
190-12	Nut, SM4.37	S03657-001	1
190-13	Spring, plate	115163-001	1
190-14	Button clamp adjust plate	115164-001	1
190-15	Shoulder screw, M4.37	115165-001	1
190-16	Shoulder screw, SM4.37	115166-001	1
190-17	Button clamp plate cam	S03659-001	1
190-18	Screw, pan SM4.37 – 40 x 8	062680-812	2

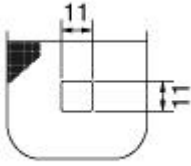
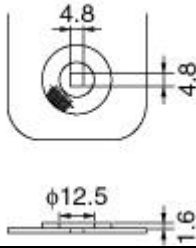
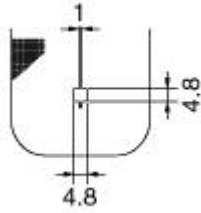
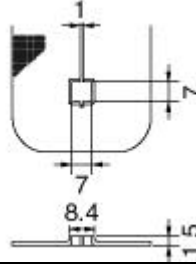
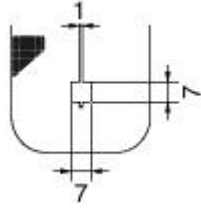
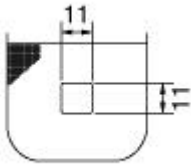
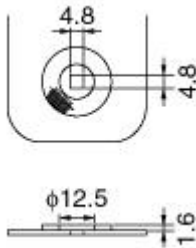
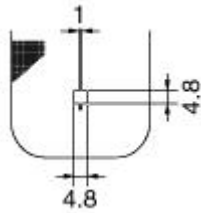
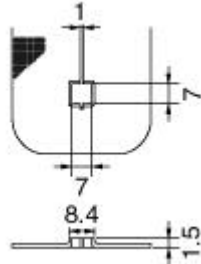
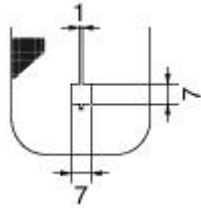

# Gauge parts list

## Feed plate

159971-001	145665-101	154166-101	153833-101	153870-101
Standard 				
S49950-001	S49951-001	S49952-001	S49953-001	S49954-001
				
S49955-001				
				

## Spring for making space between button and material

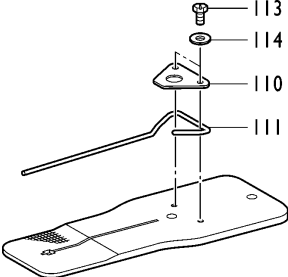
	Ref. No.	Part name	Part code	Q'ty
	110	Presser plate	153837-001	1
	111	Spring, 0.8 < $\phi$ 0.8>	153839-001	1
	111	Spring, 1.2 < $\phi$ 1.2>	153871-001	1
	113	Bolt, SM3.57	144075-001	2
	114	Washer, plain S3.5	025350-132	2

## Spacer, ;Button clamp

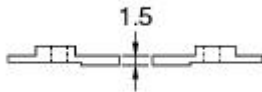
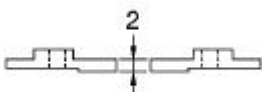
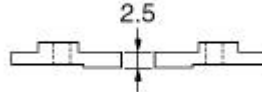
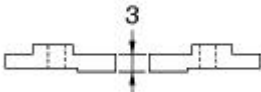
AL	S52071-001	BL	S52072-001	CL	S52073-001	DL	S52074-001
AR	S52075-001	BR	S52076-001	CR	S52077-001	DR	S52078-001
<b>Standard</b>							
							

**Needle hole plate**

HS	S40917-001	HT	S40925-001	HU	S52079-001	HV	S52080-001
HW	S52081-001	HX	S52082-001				
		<p><b>Standard</b></p>					