

LS2-B891

LT2-B892

Single Needle Unison Feed Lock Stitcher
Single Needle Unison Feed Lock Stitcher
with Thread Trimmer

Twin Needle Unison Feed Lock Stitcher
Twin Needle Unison Feed Lock Stitcher
with Thread Trimmer



Specifications

	No. of needles	Needle gauge (mm)	Height of presser foot (mm)	Max. stitch length (mm)	Max. sewing speed (rpm)
LS2-B891	1	-	Manual 9 Knee 16 Auto 16 (-705)	9 (Both forward and reverse)	3,500
LT2-B892	2	3, 4, 6, 8, 10, 12			

LS2-B891-□05, LT2-B892-□05









	0	7
Thread trimmer	—	○
Quick reverse switch	—	○
Alternating presser foot movement change switch	—	○
Auto backtack select switch	—	○
Needle up switch	—	○
Stitch length change switch	—	○
Automatic presser foot lifter	—	○
F-40 operation panel	—	○

Sewing speed range (-705)

Stitch length	6 mm and less	6 – 9 mm
Alternating presser Foot movement amount		
1.0 – 2.4 mm	3,500 rpm	2,000 rpm
2.5 – 3.9 mm	3,000 rpm	2,000 rpm
4.0 – 4.7 mm	2,500 rpm	2,000 rpm
4.8 – 7.0 mm	2,000 rpm	2,000 rpm

Panel operation guide (-705)



Basic function

		B-40
AUTO	Automatic sewing	<input type="radio"/>
	Start backtack (0-9)	<input type="radio"/>
	End backtack (0-9)	<input type="radio"/>
	Continuous backtack (0-9)	<input type="radio"/>
	Correction sewing	<input type="radio"/>
	Half stitch	<input type="radio"/>
	Sewing speed setting	<input type="radio"/>
	Slow start sewing	<input type="radio"/>
	Needle up stop / Needle down stop	<input type="radio"/>

Motor

- 005 : Clutch motor (2 pole, 550 W)
- 007 : Special MD 600 AC servomotor

Pattern sewing

		B-40
	Fixed stitch (1-99)	<input type="radio"/>
	Name label stitch (1-99)	<input type="radio"/>
	Pleats presser stitch (1-99)	<input type="radio"/>

Pattern setting

		B-40
	Automatic thread trimming	<input type="radio"/>

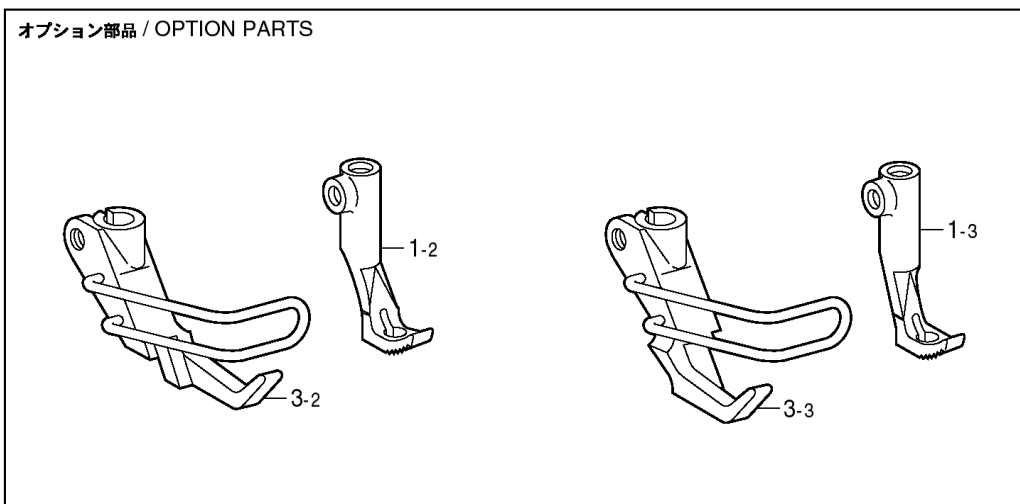
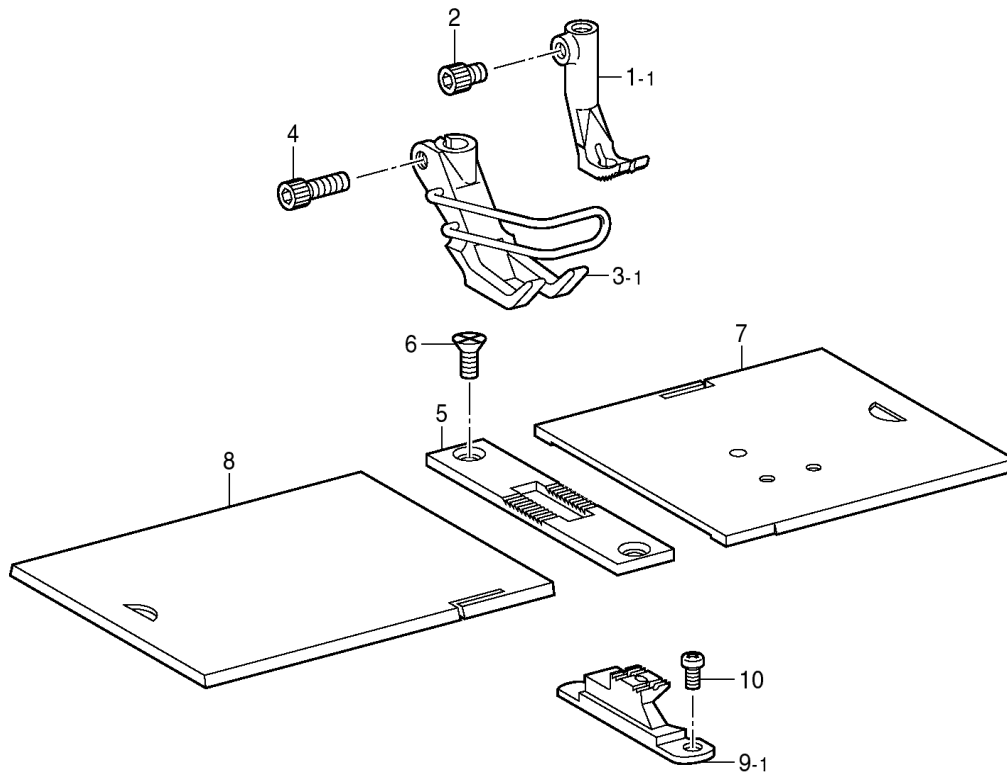

Ref. No.	Part name	Part code	Q'ty
1-1	Inner presser foot	SSSS60-049	1
2	Bolt, socket M4 × 5	SSSS60-048	1
3-1	Outer presser foot assy	SSSS30-051	1
4	Bolt, socket M4 × 10	SSSS27-174	1
5	Needle plate	SSSS60-234	1
6	Screw, flat M4 × 8	SSSS60-235	2
7	Slide plate, R	SSSS60-236	1
8	Slide plate, L	SSSS60-237	1
9-1	Feed dog	SSSS60-309	1
10	Screw, pan M4 × 10	062401-012	2
	Option parts		
1-2	Inner presser foot, A	SSSS60-400	1
3-2	Outer presser foot assy, A	SSSS60-410	1
1-3	Inner presser foot, B	SSSS60-401	1
3-3	Outer presser foot assy, B	SSSS60-411	1

< 針幅3mm用
/ For Needle gauge : 3mm >

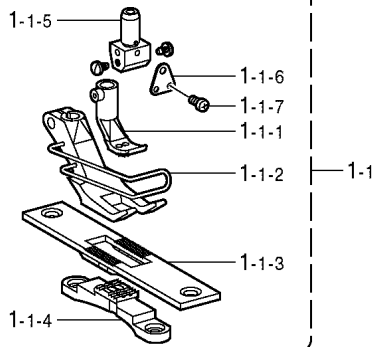

< 針幅4mm用
/ For Needle gauge : 4mm >

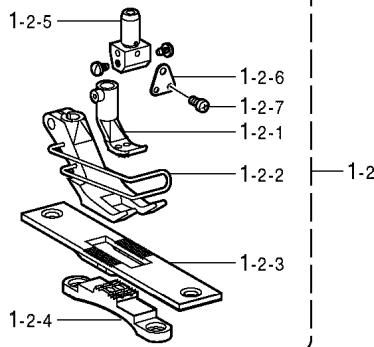

< 針幅6mm用
/ For Needle gauge : 6mm >

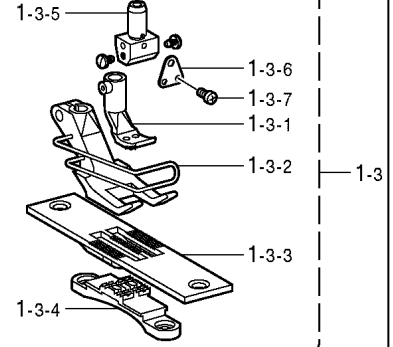

< 針幅8mm用
/ For Needle gauge : 8mm >

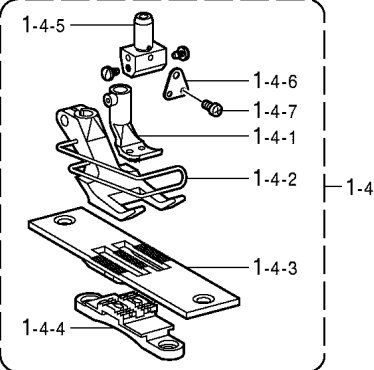

< 針幅10mm用
/ For Needle gauge : 10mm >

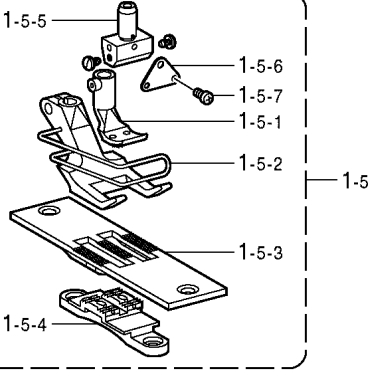

< 針幅12mm用
/ For Needle gauge : 12mm >

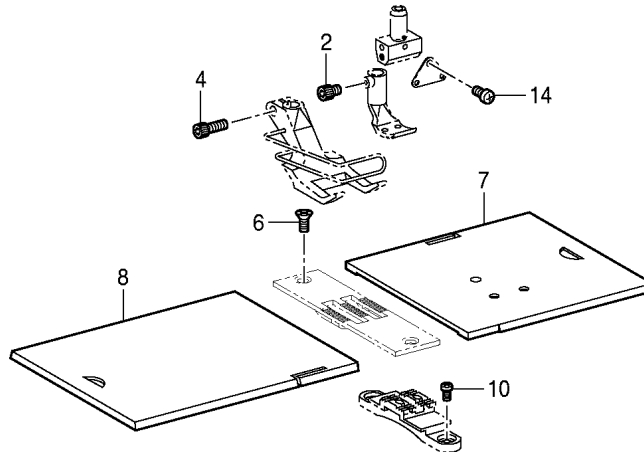
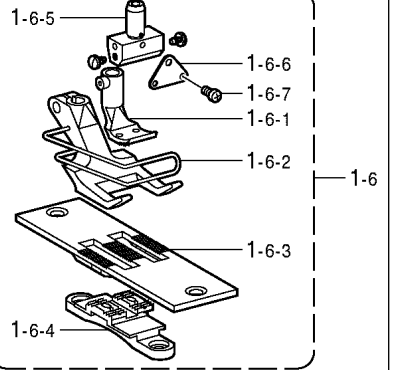

* If you change from single needle to twin needle, replace with the above gauge as well.

Gauge parts

[Models LT2-B892]

Ref. No.	Part name	Part code	Q'ty
	< For needle gauge : 3 mm >		
1-1	Gauge set, 3	SSSC60-690	1
1-1-1	Inner presser foot, 3	SSSS60-670	1
1-1-2	Outer presser foot assy, 3-4	SSSS60-680	1
1-1-3	Needle plate, 3	SSSS60-640	1
1-1-4	Feed dog, 3	SSSS60-650	1
1-1-5	Needle clamp assy, 3	SSSS60-660	1
1-1-6	Thread guide, 6	SSSS60-624	1
1-1-7	Screw, pan SM2.38 - 56 × 4	062630-412	1
	< For needle gauge : 4 mm >		
1-2	Gauge set, 4	SSSC60-691	1
1-2-1	Inner presser foot, 4	SSSS60-671	1
1-2-2	Outer presser foot assy, 3-4	SSSS60-680	1
1-2-3	Needle plate, 4	SSSS60-641	1
1-2-4	Feed dog, 4	SSSS60-651	1
1-2-5	Needle clamp assy, 4	SSSS60-661	1
1-2-6	Thread guide, 6	SSSS60-624	1
1-2-7	Screw, pan SM2.38 - 56 × 4	062630-412	1
	< For needle gauge : 6 mm >		
1-3	Gauge set, 6	SSSC60-692	1
1-3-1	Inner presser foot, 6	SSSS60-672	1
1-3-2	Outer presser foot assy, 6	SSSS60-681	1
1-3-3	Needle plate, 6	SSSS60-642	1
1-3-4	Feed dog, 6	SSSS60-652	1
1-3-5	Needle clamp assy, 6	SSSS60-662	1
1-3-6	Thread guide, 6	SSSS60-624	1
1-3-7	Screw, pan SM2.38 - 56 × 4	062630-412	1
	< For needle gauge : 8 mm >		
1-4	Gauge set, 8	SSSC60-693	1
1-4-1	Inner presser foot, 8	SSSS60-673	1
1-4-2	Outer presser foot assy, 8	SSSS60-682	1
1-4-3	Needle plate, 8	SSSS60-643	1
1-4-4	Feed dog, 8	SSSS60-653	1
1-4-5	Needle clamp assy, 8	SSSS60-663	1
1-4-6	Thread guide, 6	SSSS60-624	1
1-4-7	Screw, pan SM2.38 - 56 × 4	062630-412	1
	< For needle gauge : 10 mm >		
1-5	Gauge set, 10	SSSC60-694	1
1-5-1	Inner presser foot, 10	SSSS60-674	1
1-5-2	Outer presser foot assy, 10	SSSS60-683	1
1-5-3	Needle plate, 10	SSSS60-644	1
1-5-4	Feed dog, 10	SSSS60-654	1
1-5-5	Needle clamp assy, 10	SSSS60-664	1
1-5-6	Thread guide, 12	SSSS60-625	1
1-5-7	Screw, pan SM2.38 - 56 × 4	062630-412	1
	< For needle gauge : 12 mm >		
1-6	Gauge set, 12	SSSC60-695	1
1-6-1	Inner presser foot, 12	SSSS60-675	1
1-6-2	Outer presser foot assy, 12	SSSS60-684	1
1-6-3	Needle plate, 12	SSSS60-645	1
1-6-4	Feed dog, 12	SSSS60-655	1
1-6-5	Needle clamp assy, 12	SSSS60-665	1
1-6-6	Thread guide, 12	SSSS60-625	1
1-6-7	Screw, pan SM2.38 - 56 × 4	062630-412	1
2	Bolt, socket M4 × 5	SSSS60-048	1
4	Bolt, socket M4 × 10	SSSS27-174	1
6	Screw, flat M4 × 8	SSSS60-235	2
7	Slide plate, R	SSSS60-236	1
8	Slide plate, L	SSSS60-237	1
10	Screw, pan M4 × 10	062401-012	2
14	Screw, pan SM2.38 - 56 × 4	062630-412	1

< -005仕様用変更部品 / Conversion parts to "-005" spec. >

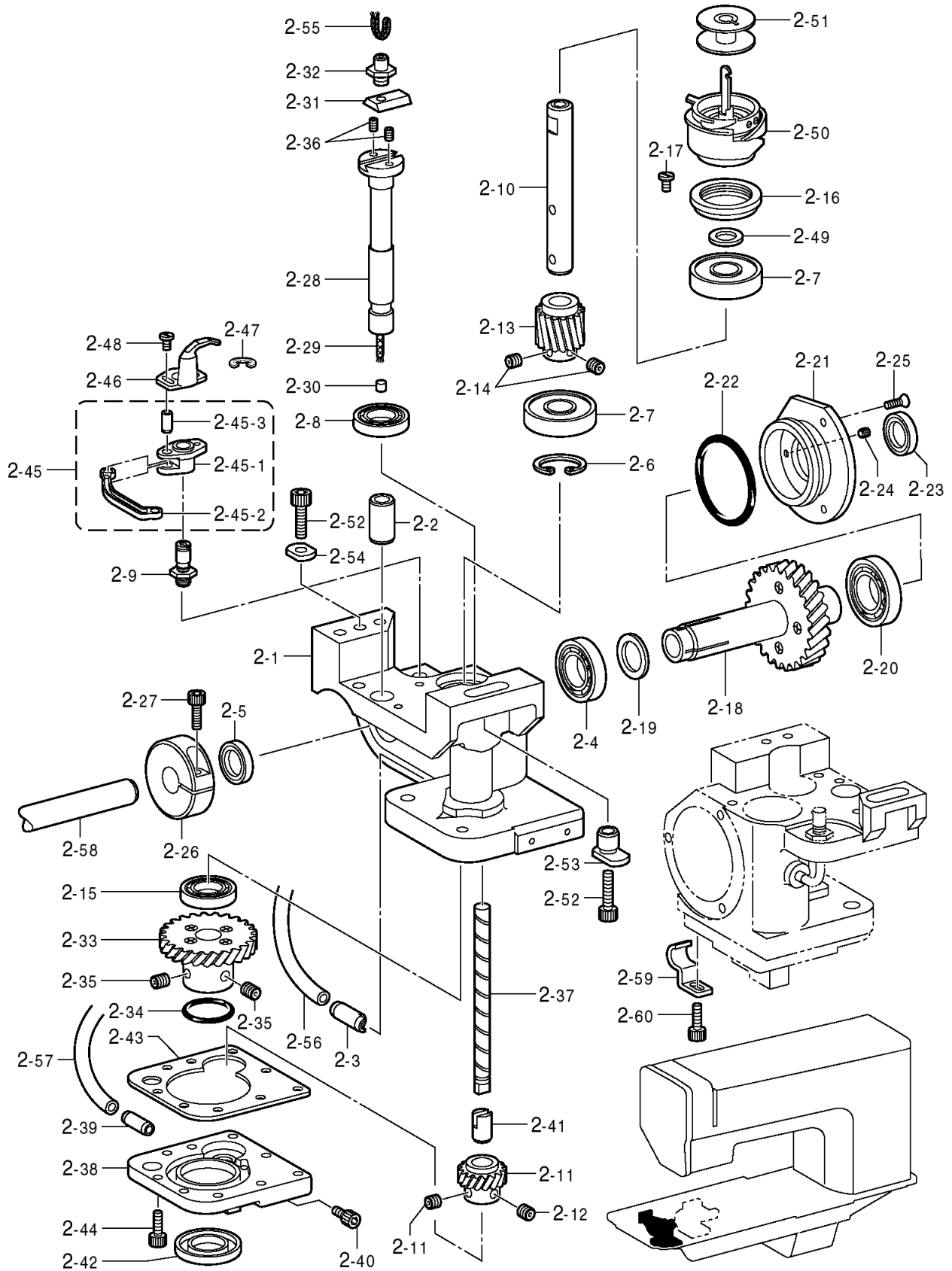

Conversion parts set (Single needle to twin needle)

[Models LS2-B891]

Ref. No.	Part name	Part code	Q'ty
	< Conversion parts to "- 005" spec. >		
2	Horizontal hook base assy, L	SSSC60-696	1
2-1	Horizontal hook base, L	SSSS60-600	1
2-2	Bushing, U	SSSS60-295	1
2-3	Pipe	SSSS60-357	1
2-4	Ball bearing	SSSS60-267	1
2-5	Oil seal	SSSS60-243	1
2-6	Retaining ring, internal C26	SSSS60-259	1
2-7	Ball bearing	SSSS60-262	2
2-8	Ball bearing	SSSS60-603	1
2-9	Pin	SSSS60-602	1
2-10	Horizontal hook shaft	SSSS60-253	1
2-11	Gear, S OP-shaft	SSSS60-290	1
2-12	Set screw, socket (CP) M5 × 5	SSSS18-028	2
2-13	Gear, S	SSSS60-256	1
2-14	Set screw, socket (CP) M5 × 5	SSSS18-028	2
2-15	Ball bearing	SSSS60-604	1
2-16	Oil pan, h-hook shaft	SSSS60-258	1
2-17	Screw, M5 × 5	SSSS37-509	2
2-18	Lower shaft gear assy	SSSS60-269	1
2-19	Washer	SSSS60-270	1
2-20	Ball bearing	SSSS60-267	1
2-21	Lower shaft holder, BR	SSSS60-264	1
2-22	O ring	SSSS60-266	1
2-23	Oil seal	SSSS60-243	1
2-24	Set screw, socket (CP) M4 × 5	SSSS37-229	3
2-25	Screw, flat M4 × 6	SSSS37-210	3
2-26	Collar, h-hook	SSSS60-271	1
2-27	Bolt, socket M6 × 18	SSSS28-076	1
2-28	Opener shaft	SSSS60-281	1
2-29	Oil wick, 80	SSSS60-282	1
2-30	Rubber cap, 4.2	142274-009	1
2-31	Adjusting guide rail, OP	SSSS60-288	1
2-32	Adjusting pin, opener	SSSS60-278	1
2-33	Gear base assy, OP	SSSS60-291	1
2-34	O ring, 10	SSSS18-420	1
2-35	Set screw, socket (CP) M5 × 6	SSSS27-170	2
2-36	Set screw, socket (CP) M3 × 6	SSSS60-280	2
2-37	Lubrication shaft	SSSS60-260	1
2-38	Oil tank, h-hook base	SSSS60-601	1
2-39	Pipe	SSSS60-357	1
2-40	Bolt, socket M3 × 6	SSSS18-349	1
2-41	Bushing, lubrication shaft	SSSS60-261	1
2-42	Oil seal	SSSS60-247	1
2-43	Sheet packing	SSSS60-244	1
2-44	Bolt, socket M4 × 10	SSSS27-174	9
2-45	Setting bracket assy, Opener	SSSC60-279	1
2-45-1	Setting bracket, Opener	SSSS60-279	1
2-45-2	Opener arm	SSSS60-286	1
2-45-3	Pin	SSSS60-287	1
2-46	Opener, BC	SSSS60-276	1
2-47	Retaining ring, E4	SSSSS4-839	1
2-48	Screw, M3 × 6	SSSS37-269	2
2-49	Spacer, 0.3 t = 0.3	SS6024-101	1
2-49	Spacer, 0.4 t = 0.4	SS6024-102	1
2-49	Spacer, 0.5 t = 0.5	SS6024-103	1
2-49	Spacer, 0.2 t = 0.2	SS6024-104	1
2-50	Horizontal hook assy	SSSS60-482	1

< -005仕様用変更部品 / Conversion parts to "-005" spec. >

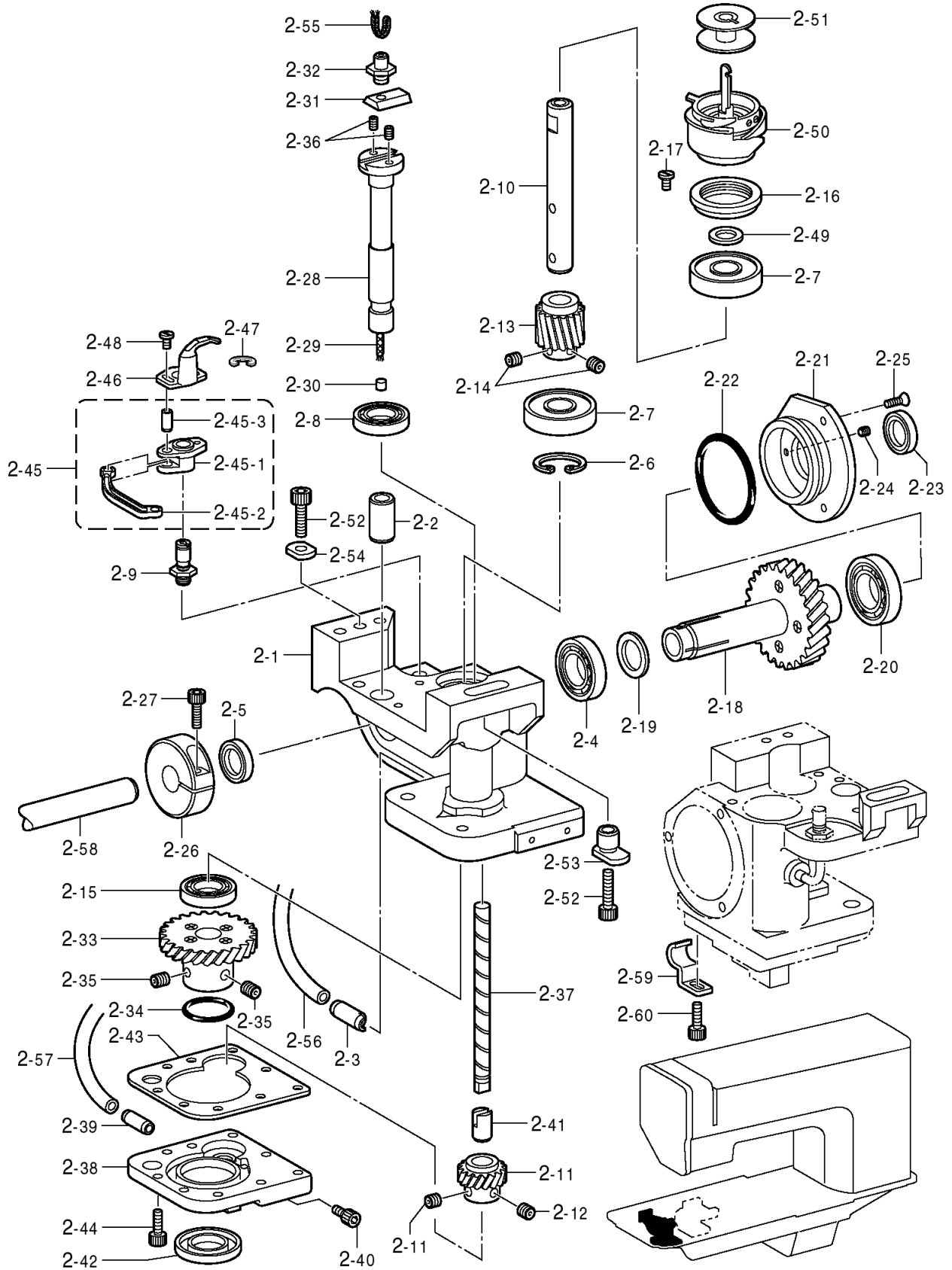

Conversion parts set (Single needle to twin needle)

[Models LS2-B891]

Ref. No.	Part name	Part code	Q'ty
	< Conversion parts to "- 005" spec. >		
2-51	Bobbin	SSSS60-240	1
2-52	Bolt, socket M6 × 25	SSSS38-124	2
2-53	Eccentric collar	SSSS60-252	1
2-54	Washer	SSSS60-245	1
2-55	Oil wick, 50	SSSS60-273	1
2-56	Oil tube, 170	SSSS60-620	1
2-57	Oil tube, 300	SSSS60-621	1
2-58	Lower shaft	SSSS60-605	1

< -705仕様用変更部品 / Conversion parts to "-705" spec. >

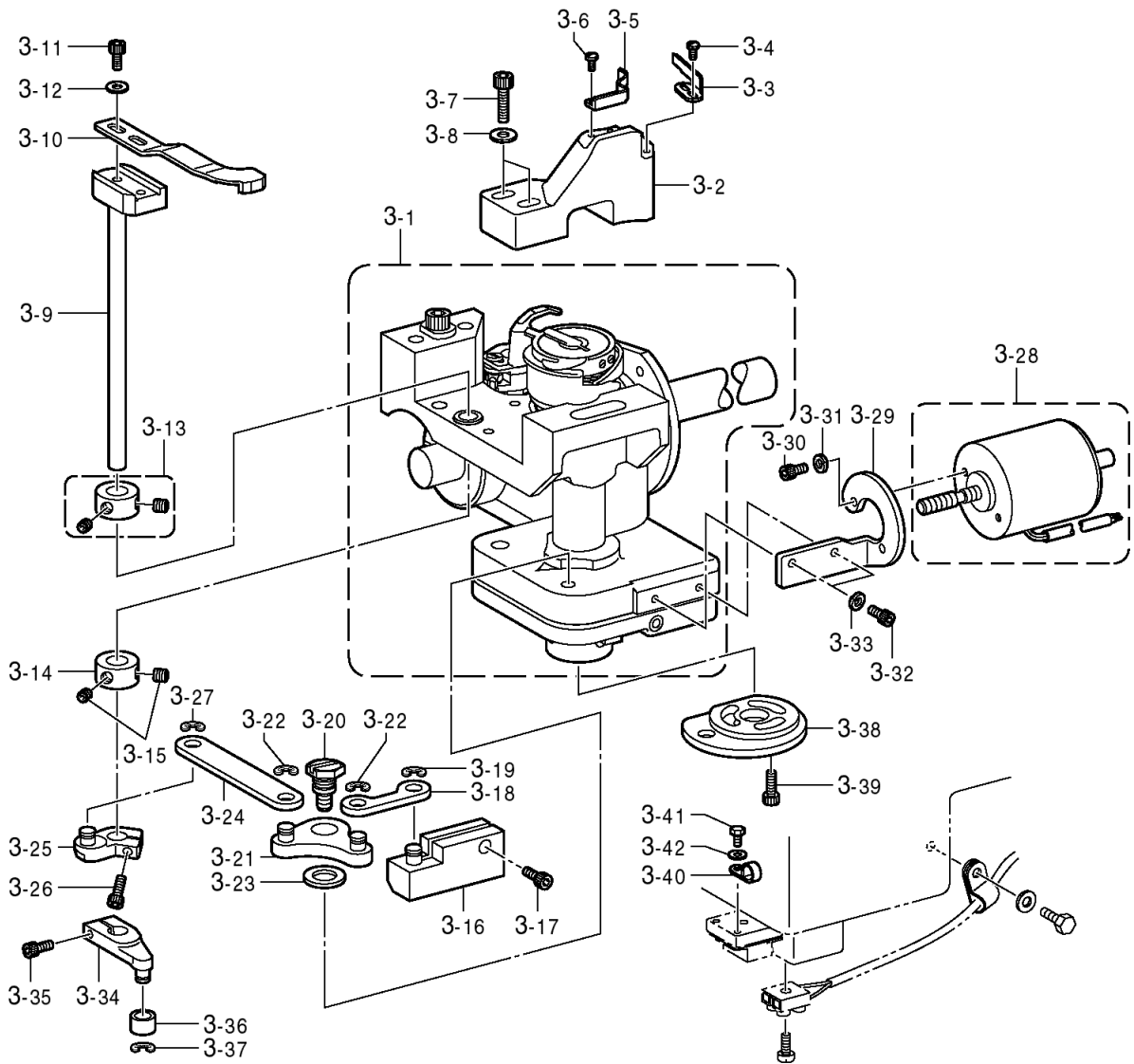

< 共通部品 / Common parts >

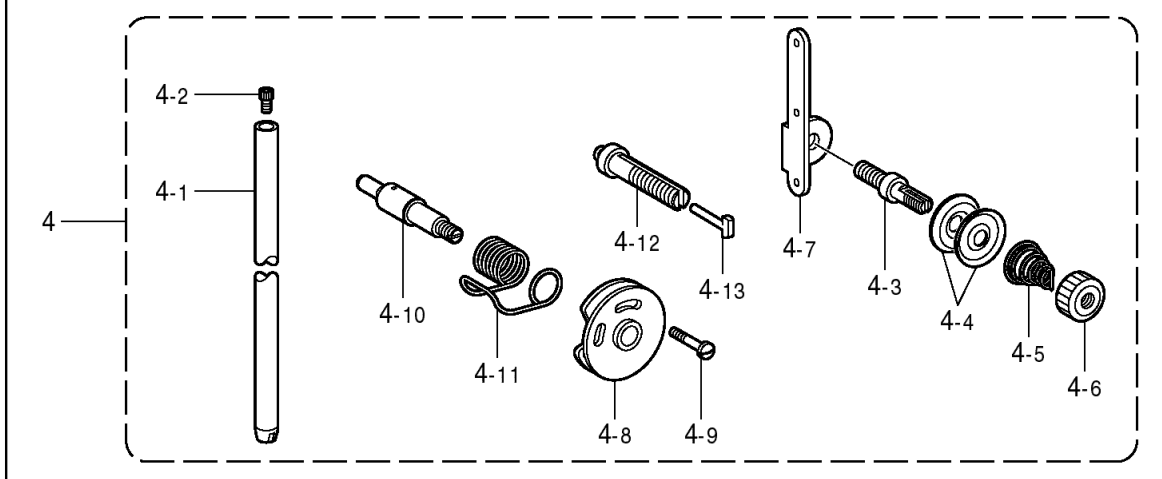

Conversion parts set (Single needle to twin needle)

[Models LS2-B891]

Ref. No.	Part name	Part code	Q'ty
	< Conversion parts to "- 705" spec. >		
3	H-hook base assy, L-TR	SSSC60-697	1
3-1	Horizontal hook base assy, L	SSSC60-696	1
3-2	Support bracket, F-knife	SSSS60-303	1
3-3	Fixed knife	SSSS60-302	1
3-4	Screw, SM3.57 × 8	SSSSS8-031	2
3-5	Spring, thread holding	SSSS60-304	1
3-6	Screw, SM3.57 × 8	SSSSS8-031	2
3-7	Bolt, socket M5 × 25	SSSS27-178	2
3-8	Washer, plain M5	SSSS16-287	2
3-9	Driving knife shaft	SSSS60-294	1
3-10	Driving knife	SSSS60-292	1
3-11	Bolt, socket M3 × 6	SSSS18-349	2
3-12	Washer, plain M3	SSSS31-111	2
3-13	Set screw collar assy	S21775-001	1
3-14	Set screw collar	SSSS60-635	1
3-15	Set screw, socket (CP) SM4.37	014680-422	2
3-16	Thread trimmer sol. arm assy	SSSS60-610	1
3-17	Bolt, socket M4 × 10	SSSS27-174	1
3-18	Link, A	SSSS60-611	1
3-19	Retaining ring, E3	SSSSS4-835	1
3-20	Shoulder screw, M6	SSSS60-612	1
3-21	Driving knife arm assy, D	SSSS60-613	1
3-22	Retaining ring, E3	SSSSS4-835	2
3-23	Washer, plain 6	156265-001	1
3-24	Link, B	SSSS60-614	1
3-25	Driving knife arm assy, C	SSSS60-615	1
3-26	Bolt, socket M4 × 12	SSSS31-092	1
3-27	Retaining ring, E3	SSSSS4-835	1
3-28	Thread trimmer solenoid assy	SSSS60-617	1
3-29	Setting plate, sol.	SSSS60-616	1
3-30	Bolt, socket M4 × 10	SSSS27-174	2
3-31	Washer, spring 2-4	SSSS31-208	2
3-32	Bolt, socket M4 × 10	SSSS27174	2
3-33	Washer, spring 2-4	SSSS31-208	2
3-34	Driving knife arm	SSSS60-298	1
3-35	Bolt, socket M4 × 14	SSSS34-008	1
3-36	Roller	SSZ814-502	1
3-37	Retaining ring, external 4	SSZ814-503	1
3-38	Thread trimmer cam	SSSS60-307	1
3-39	Bolt, socket M4 × 12	SSSS31-092	3
3-40	Cushion clamp	SSSS30-625	1
3-41	Bolt, SM3.57	144075-001	1
3-42	Washer, plain L3.5	SSSS30-025	1
	< Common parts >		
4	T-needle gauge set	SSSC60-698	1
4-1	Needle bar	SSSS60-622	1
4-2	Bolt, socket M3 × 10	SSSS31-110	1
4-3	Tension adjusting stud, 1st	SSSS60-134	1
4-4	Tension disc	SSSS20-244	2
4-5	Tension spring	SS2022-601	1
4-6	Nut	SSSS20-225	1
4-7	Thread hook, 1st	SSSS60-133	1
4-8	Tension spring guide assy	SSSS10-694	1
4-9	Screw, SM2.38 - 56 × 12	144682-001	1
4-10	Tension stud, L	SSSS10-951	1
4-11	Spring	SSSS10-953	1
4-12	Tension stud	SSSS60-630	1
4-13	Pusher pin, L t-release	SSSS10-952	1