

# LK3–B431EMark II

# LK3–B433EMark II

**Electronic Lockstitch Belt Loop Bar Tacker**  
**Electronic Lockstitch Decorative Pattern Tacker**



## Specifications





	LK3–B431E Mark II Electronic lockstitch belt loop bar tacker		LK3–B433E Mark II Electronic lockstitch decorative pattern tacker		
	-2	-3	-1	-2	-7
Application	Bar tacking length 6 – 14 (mm)	Bar tacking length 14 – 25 (mm)	Ordinary materials	Denim	Knitted materials
Stitch formation	Single needle lock stitch				
Max. sewing speed (X × Y)	2,700 rpm		2,500 rpm		
Max. pattern size	Max. 30 × 10 mm		Max. 30 × 30 mm		
Feed mechanism	R-θ intermittent feed mechanism (pulse–motor driven mechanism)				
Stitch length	0.1–10.0 mm				
No. of stitches	Variable (21, 28, 35, 42, 45 stitches pre–set)		Variable		
Max. stitch number	20,000 stitches (including 10,000 stitches which can be added.)				
Work clamp lifter	Solenoid type				
Work clamp height	17mm max.				
Hook	Shuttle hook (shuttle hook 2, optional)				
Wiper device	Standard equipment				
Thread trimmer device	Standard equipment				
Thread take-up device	Standard equipment		Standard equipment (Option for –2 spec.)		
Data storage method	PROM (Any sewing pattern can be added using BAS–PC300.)				
No. of user programs	16				
No. of cycle programs	4				
No. of stored data	6 sewing patterns are set already.				
	(Up to 100 patterns can be added. Total number of stitches of stored data which can be added is within 10,000.)				
Motor	Three phase 400W induction motor				
Weights	Machine head: 47kg, Operation panel: 0.6kg, Control box; 9–19kg (depending on destination)				
Power supply	Single phase 110, 220–230V Three phase 220, 240, 380, 400V Maximum electric power consumption; 600VA				

# LK3-B431E Mark II-

Subclass	Materials
-2	Bar tacking length 6– 14 mm
-3	Bar tacking length 14– 25 mm

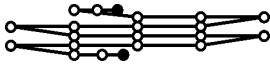
\*A presser foot and feed plate for sewing area 30 × 10mm can be accommodated by special order.

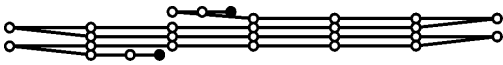
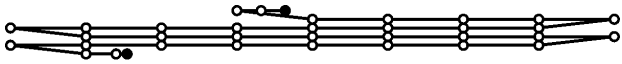
## LK-B431E Mark II List of pre-programmed patterns

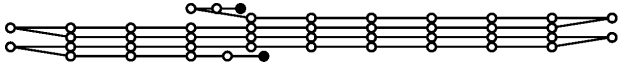
Pattern No.	Sewing pattern	No. of stitches	Standard bar tacking length	Standard bar tacking width
1		21	10 mm	0.3 mm
2		28	10 mm	0.3 mm
3		28	20 mm	0.3 mm
4		35	25 mm	0.3 mm
5		42	25 mm	0.3 mm
6		45	25 mm	0.3 mm

\*Length when the sewing size is 100%.

## LK3–B433E Mark II

\*The presser foot, feed plate and P–ROM can be ordered and manufactured to the customers' detailed specifications.

## LK3–B433EX Mark II–

Subclass	Materials
-1	Ordinary materials
-2	Denim
-7	Knitted materials

\*If you wish to create sewing patterns or modify the presser foot and feed plate yourself, please order the LK3–B433EX MarkII. (At the time of shipment, the P–ROM for the B433EX MarkII will be blank and the presser foot and feed plate will be unmodified.)

# Optional device Thread take-up mechanism

< デニム用 (B430E, B433E) / For Denim (B430E, B433E) >

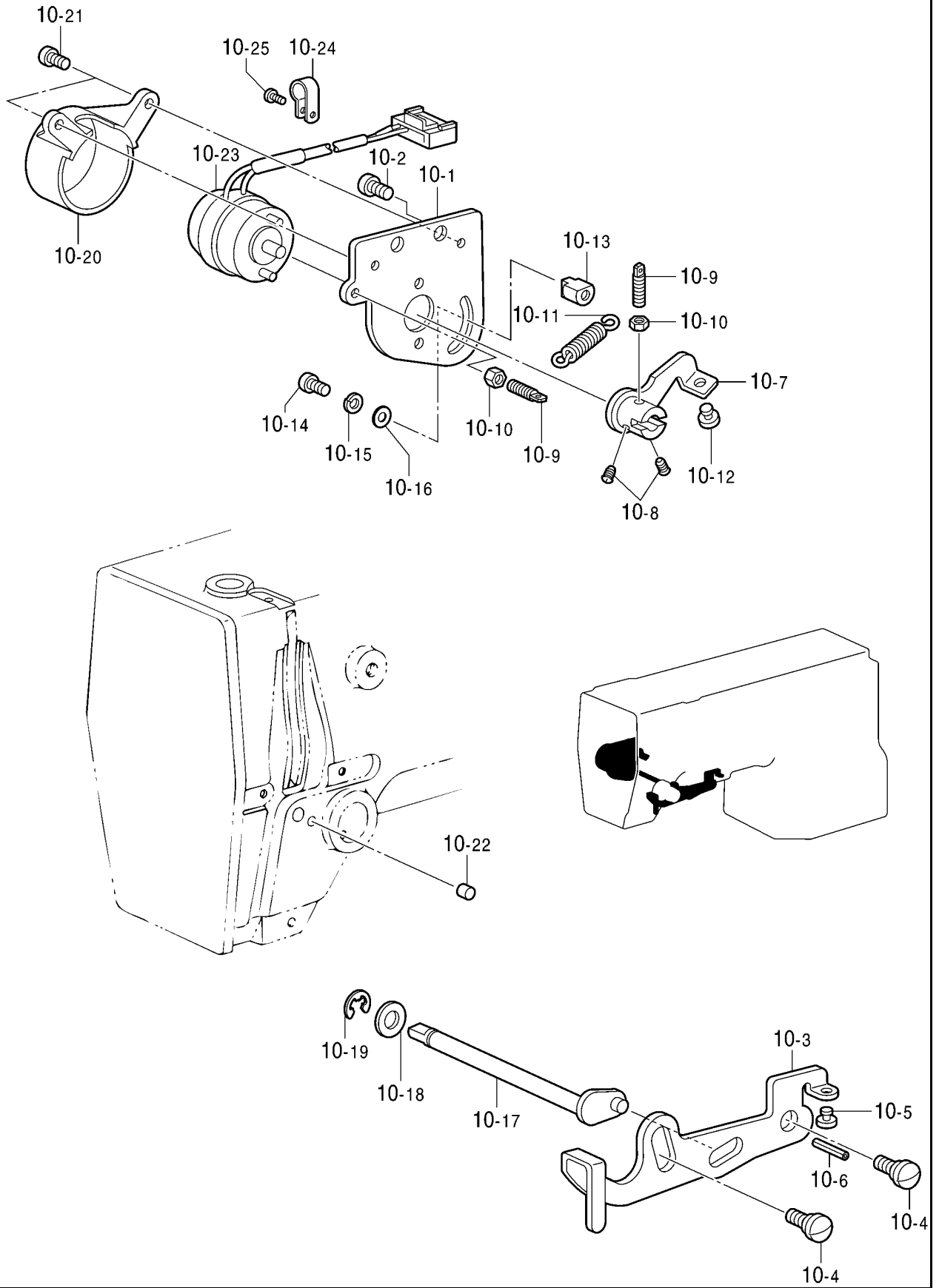





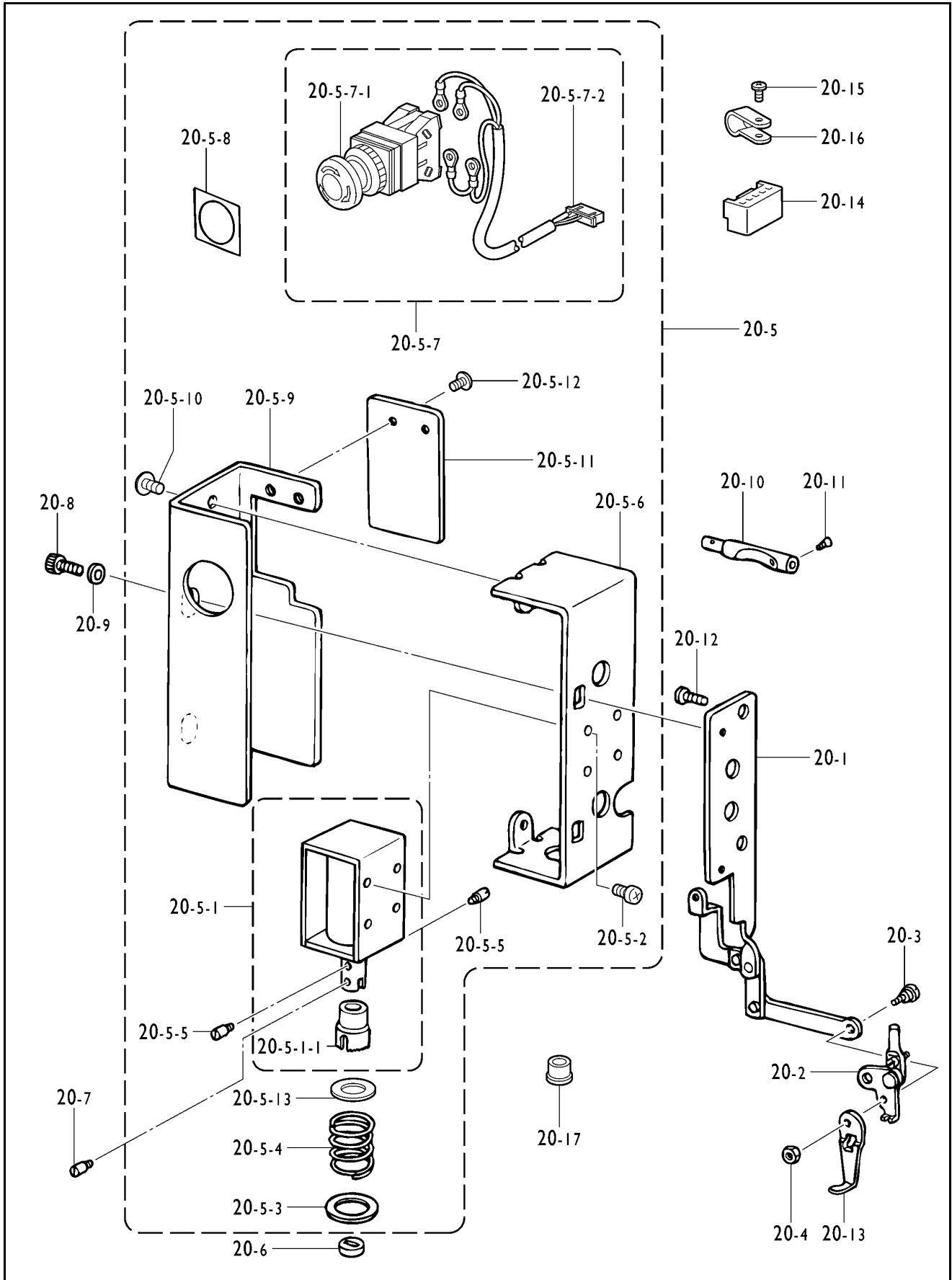





Ref. No.	Part name	Part code	Q'ty
<b>&lt;Option parts for Denim&gt;</b>			
10	Thread take-up device	S49956-001	1
10-1	Solenoid setting plate	S49659-001	1
10-2	Screw, pan SM4.76 – 32×8	062710-812	2
10-3	Thread take-up lever	S49660-001	1
10-4	Shoulder screw, SM4.76	107321-003	2
10-5	Differential crank cushion	S19748-001	1
10-6	Pin, spring roll AW4	047401-442	1
10-7	Thread trimming solenoid joint	S49661-001	1
10-8	Set screw, SM3.57	S01998-001	2
10-9	Spring hook	110251-001	2
10-10	Nut, 1 SM3.57	021670-102	2
10-11	Thread trimmer spring	S34883-001	1
10-12	Differential crank cushion	S19748-001	1
10-13	Nut, SM3.57	S49663-001	1
10-14	Screw, pan SM3.57 – 40×10	062671-012	1
10-15	Washer, spring 2 - 3.5	028350-242	1
10-16	Washer, plain L3.5	025350-332	1
10-17	Crankshaft	S49662-001	1
10-18	Washer, plain	155559-001	1
10-19	Retaining ring, E4	048040-342	1
10-20	Thread take-up solenoid cover	S49664-000	1
10-21	Screw, pan SM3.57 – 40×8	062670-812	2
10-22	Rubber cap, 5.3	S20878-000	1
10-23	Thread take-up solenoid	S49464-000	1
10-24	Cord holder, 5N	S00480-000	3
10-25	Screw, bind SM3.57 – 40×6	060670-612	3

**Optional device  
Solenoid thread wiper**



Ref. No.	Part name	Part code	Q'ty
20	Thread wiper solenoid assy	S49615-009	1
20-1	Thread wiper connect rodassy	S41656-001	1
20-2	Thread wiper armassy	S44600-001	1
20-3	Shoulder screw, SM3.57	153112-001	1
20-4	Nut, 2 SM3.57	021670-202	1
20-5	Solenoid box assy	S49616-009	1
20-5-1	Thread wiper solenoid assy	S49619-001	1
20-5-1-1	Plunger rubber	S41204-050	1
20-5-2	Screw, pan M3 x 6	062300-612	4
20-5-3	Washer, plain	S41205-001	1
20-5-4	Spring, t-wiper	S41206-001	1
20-5-5	Plunger pin	S25456-001	2
20-5-6	Setting plate, W-sol.	S42017-109	1
20-5-7	EM-lock switch harness assy	S49482-000	1
20-5-7-1	Switch, AVS311N	S32335-000	1
20-5-7-2	EM-switch harness	S49466-000	1
20-5-8	EM-switch spacer, 3	S37057-001	1
20-5-9	Solenoid cover, W	S42018-109	1
20-5-10	Screw, truss M4 x 6	008400-604	2
20-5-11	Solenoid cover lid, E	S37806-109	1
20-5-12	Screw, truss M4 x 6	008400-604	2
20-5-13	Washer, plain 13	115007-001	1
20-6	Spacer rubber	S41207-000	1
20-7	Plunger pin	S25456-001	1
20-8	Bolt, socket M4 x 6	018400-632	2
20-9	Washer	100645-003	2
20-10	Tension release rod, DW	S41657-001	1
20-11	Screw, flat M3.5 x 6	061350-616	1
20-12	Screw, pan SM4.37-40 x 8	062680-812	2
20-13	Thread wiper, A	156206-001	1
20-14	Connector	S49947-000	1
20-15	Screw, bind SM3.57-40 x 6	060670-612	3
20-16	Cord holder, 7N	149287-000	3
20-17	Rubber cap, 15.5	104449-009	1







## Different parts list

Specification	B431E MarkII		B433E MarkII		
	-2	-3	-2	-1	-7
Use	Bar tacking length 6 – 14 mm	Bar tacking length 14 – 25 mm	For denim	For ordinary materials	For knitted materials
Part name					
Needle hole plate 	(φ2.2) S49980-001 FM		(φ2.6) S10212-101 E	(φ2.2) S49980-001 FM	(φ1.6) S10211-001 A
Bobbin case assy 	159610-201 A	◎	152690-301 B	159610-201 A	159610-201 A
	S15902-401 LA	○	S15902-401 LA	S15902-401 LA	
Tensionspring 	154339-001 A	◎	154340-001 B	154339-001 A	154339-001 A
	S16074-101 LA	○	S16074-101 LA	S16074-101 LA	
Screw 	154341-001	◎	154341-001	154341-001	154341-001
	S16492-101 LA	○	S16492-101 LA	S16492-101 LA	
Spring, anti-spin 	159612-001 A	◎	154342-001 B	159612-001 A	159612-001 A
	S15667-001 LA	○	S15667-001 LA	S15667-001 LA	
Bobbin 	159613-051	◎	159613-051		159613-051
	S15665-001 LA	○	S15665-001 LA		
Shuttle hook box assy 	152685-903 A	◎	152687-902 B	152685-903 A	152685-903 A
	S15662-992 LA	○	S15663-991 LB	S15662-992 LA	
Large shuttle hook 	152682-101 A	◎	152686-101 B	152682-101 A	◎
Spring, tension 	104525-001	◎	107606-001	104525-001	◎
Spring 	145519-001	◎	144588-001 B	145519-001	◎
Thread guide, needle bar 	S41222-001 B	◎	152890-001 A	S41222-001 B	◎

\*◎: Common with the LK3-B430E.

○: Common with the BAS-311E.

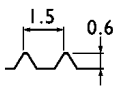
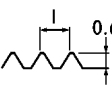

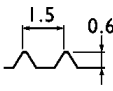
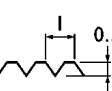
Specification	B431E MarkII		B433E MarkII		
	-2	-3	-2	-1	-7
Use	Bar tacking length 6 – 14 mm	Bar tacking length 14 – 25 mm	For denim	For ordinary materials	For knitted materials
Part name					
Needle assy	107415-414		S37928-419 <sup>⊙</sup>	107415-414	107415-409 <sup>⊙</sup>
Needle 	DP×5 #14 107415-014		DP×17 #19 <sup>⊙</sup> S37928-019	DP×5 #14 107415-014	DP×5 #9 <sup>⊙</sup> 107415-009
Work clamp arm assy	431-S S51848-001	431-L S51851-001	-		
Work clamp, U 	431-S 154416-101	431-L 154417-101			
Feed plate 	431-S S51853-001	431-L S51852-001	-		
Work clamp, blank 	-		433-2 S41353-001 	433-1 S41352-001 	
Feed plate, blank 	-		433-2 S41355-001 	433-1 S41354-001 	

## Standard parts

Standard size for work clamps and feed plates are as follows:

(The actual sewing area has 1.5 mm margin on every size; inside the lines which the dimensions indicate.)

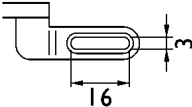
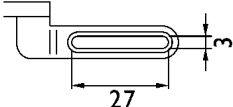
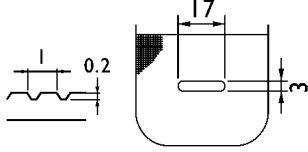
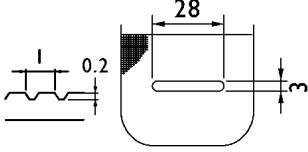
Model	B431E MarkII	
Spec.	-2	-3
	154416-101	154417-101
Work clamp		
	S51853-001	S51852-001
Feed plate		

Standard needle hole plates are as follows.

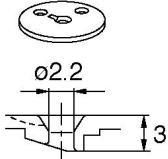
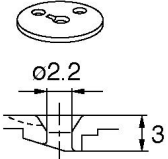
Model	B431E Mark II	
Spec.	-2	-3
	FM   S49980-001	FM   S49980-001
Needle hole plate		

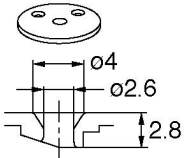
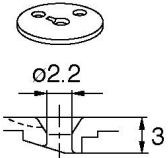
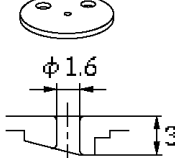
Model	B433E Mark II		
Spec.	-2	-1	-7
	E   S10212-101	FM   S49980-001	A   S10211-001
Needle hole plate			

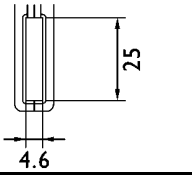
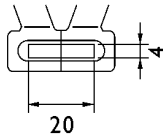
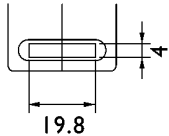
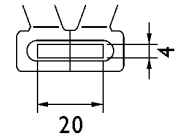
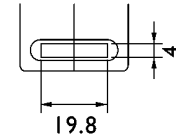
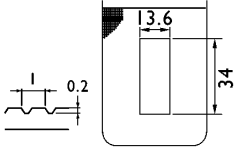
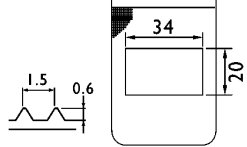
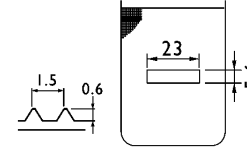

## Gauge parts list (Optional parts)

Work clamp and feed plate (For B433E MarkII)

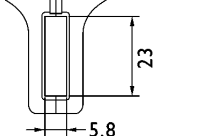
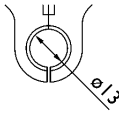
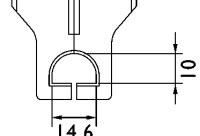
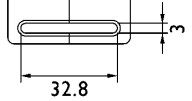
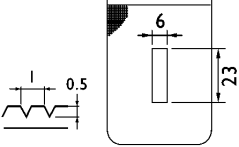
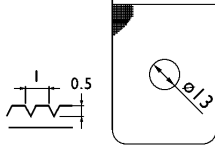
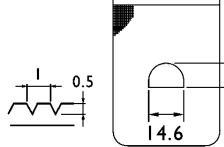
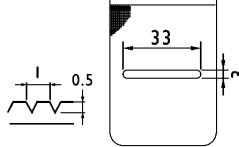
	1	2	3	4	5
R	S43441-001 (For vertical bar tacking / submerged)	S43955-001	S46212-001	S43955-001	S46212-001
L	S43442-001 (For vertical bar tacking / submerged)	S43956-001	S46213-001	S43956-001	S46213-001
Work clamp					
Feed plate	S43440-001 (For vertical bar tacking / submerged)	156087-001 (For bar tacking / submerged)		156084-001 (For bar tacking / sandwiched)	
					

	6	7	8	9
R	S46788-001 (For vertical bar tacking)	S46791-001 (For circular stitching)	S46794-001 (For crescent bar tacking)	S46785-001 (For straight bar tacking)
L	S46787-001 (For vertical bar tacking)	S46790-001 (For circular stitching)	S46793-001 (For crescent bar tacking)	S46784-001 (For straight bar tacking)
Work clamp				
Feed plate	S46786-001 (For vertical bar tacking)	S46789-001 (For circular stitching)	S46792-001 (For crescent bar tacking)	S46783-001 (For straight bar tacking)
				

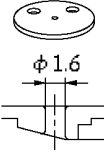
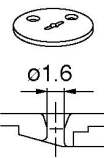
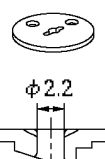
Needle hole plate (For B431E MarkII, B433E MarkII)

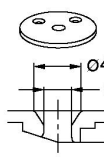
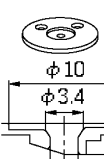
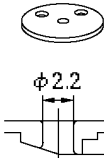
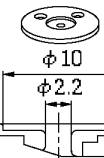
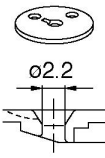
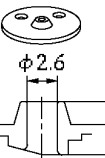
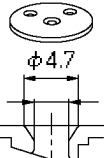
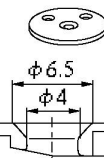
A	S10211-001	AF	S51449-001	BZ	S41013-001	D	S29997-001	E	S10212-101	ED	S30925-001
											
(For knitted materials)											
F	S10213-001	FD	S30926-001	FM	S49980-001	H	S30450-001	L	S25127-001	M	S34348-001
											
		(For ordinary materials)									