

# LK3–B434EMark II

## Electronic Lockstitch Pattern Tacker

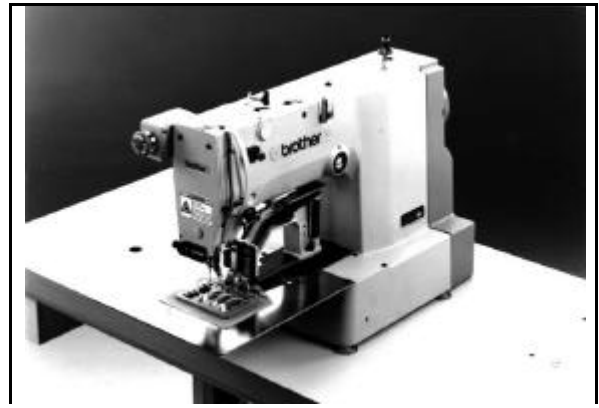

### Specifications

Model	LK3–B434E Mark II
Application	Medium, heavy, extra heavy materials
Stitch formation	Single needle lock stitch
Max. sewing speed	2,500 rpm (Pitch 3 mm)
Max. pattern size	Max. 100 × 60 mm
Feed mechanism	R–θintermittent feed mechanism (pulse–motor driven mechanism)
Stitch length	0.1–10.0 mm
No. of stitches	Variable
Max. stitch number	10,000 stitches
Work clamp lifter	Solenoid type or pneumatic type
Work clamp height	For solenoid : 17 mm max. For pneumatic : 25 mm max. (Max. 17 mm for inner clamping device)
Hook	×2 shuttle hook
Wiper device	Standard equipment
Thread trimmer device	Standard equipment
Thread take-up device	Standard equipment
Safety equipment	Built–in stopping mechanism
Data storage method	PROM (Any sewing pattern can be added using BAS–PC/300)
No. of user programs	16
No. of cycle programs	4
No. of stored data	Up to 100 patterns can be added. Total number of stitches of stored data which can be added is within 10,000.
Motor	Three phase 400W induction motor
Weights	Machine head: 49kg Operation panel: 0.6kg Control box: 9–19kg (depending on destination)
Power supply	Single phase 110V, 220–230V, 240V Three phase 220, 380, 400 Max. electric power consumption; 600VA

**Optional parts  
Solenoid thread wiper**

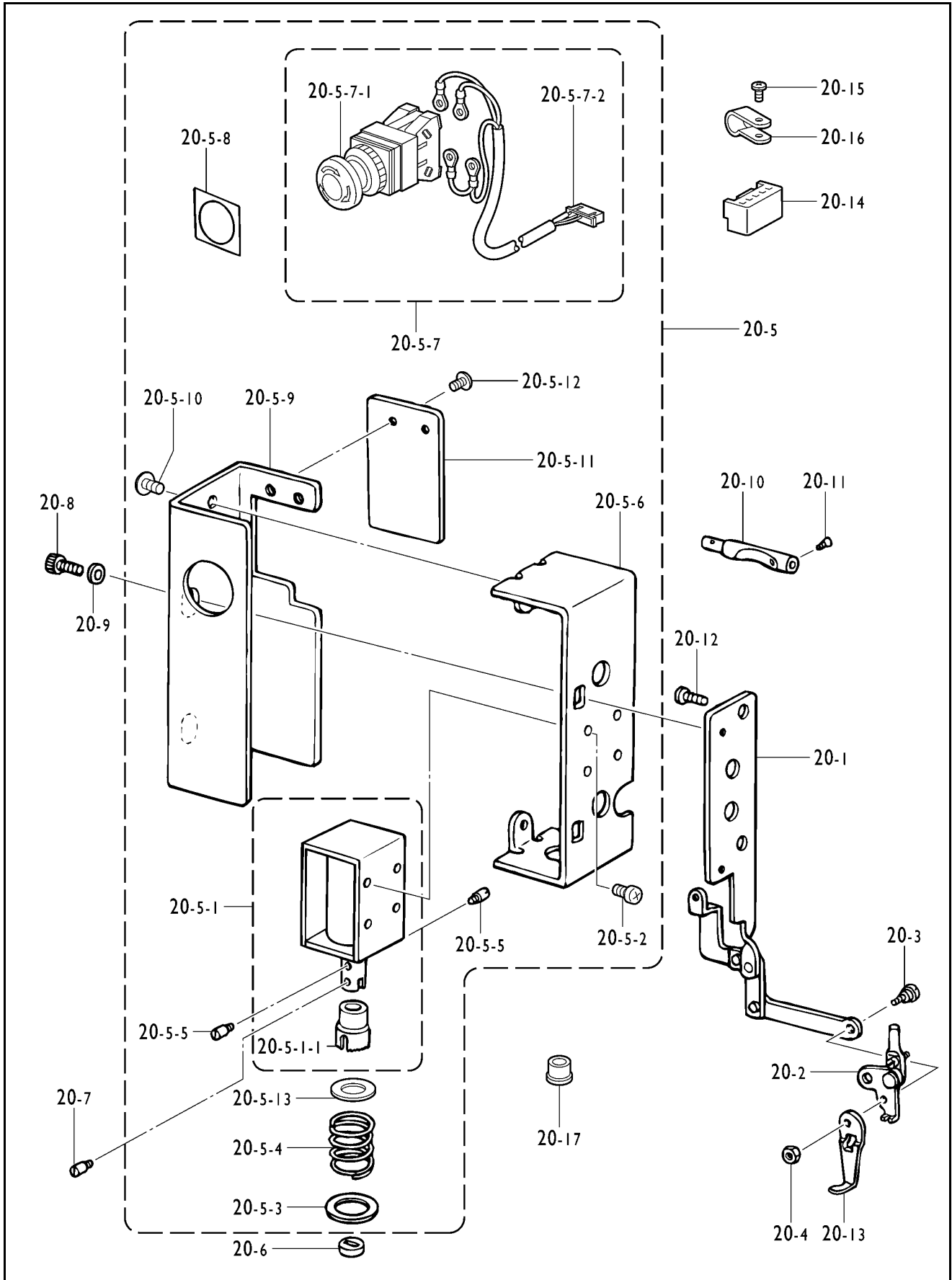

## Optional parts

### Solenoid thread wiper

Ref. No.	Part name	Part code	Q'ty
20	Thread wiper solenoid assy	S49615-009	1
20-1	Connect. rod assy, ; t-wiper	S41656-001	1
20-2	Thread wiper arm assy	S44600-001	1
20-3	Shoulder screw, SM3.57	153112-001	1
20-4	Nut, 2 SM3.57	021670-202	1
20-5	Solenoid box assy	S49616-009	1
20-5-1	Thread wiper solenoid assy	S49619-001	1
20-5-1-1	Plunger rubber	S41204-050	1
20-5-2	Screw, pan M3 x 6	062300-612	4
20-5-3	Washer, plain	S41205-001	1
20-5-4	Spring, t-wiper	S41206-001	1
20-5-5	Plunger pin	S25456-001	2
20-5-6	Setting plate, W-sol.	S42017-109	1
20-5-7	EM-lock switch & harness assy	S49482-000	1
20-5-7-1	Switch, ; AVS311N	S32335-000	1
20-5-7-2	EM-switch harness	S49466-000	1
20-5-8	Spacer, 3 ; EM-switch	S37057-001	1
20-5-9	Solenoid cover, W	S42018-109	1
20-5-10	Screw, truss M4 x 6	008400-604	2
20-5-11	Solenoid cover lid, E	S37806-109	1
20-5-12	Screw, truss M4 x 6	008400-604	2
20-5-13	Washer, plain 13	115007-001	1
20-6	Spacer rubber	S41207-000	1
20-7	Plunger pin	S25456-001	1
20-8	Bolt, socket M4 x 6	018400-632	2
20-9	Washer	100645-003	2
20-10	Tension release rod, DW	S41657-001	1
20-11	Screw, flat M3.5 x 6	061350-616	1
20-12	Screw, pan SM4.37 - 40 x 8	062680-812	2
20-13	Thread wiper, A	156206-001	1
20-14	Connector, ; VHR-5N	S49947-000	1
20-15	Screw, bind SM3.57-40 x 6	060670-612	3
20-16	Cord holder, 7N	149287-000	3
20-17	Rubber cap, 15.5	104449-009	1





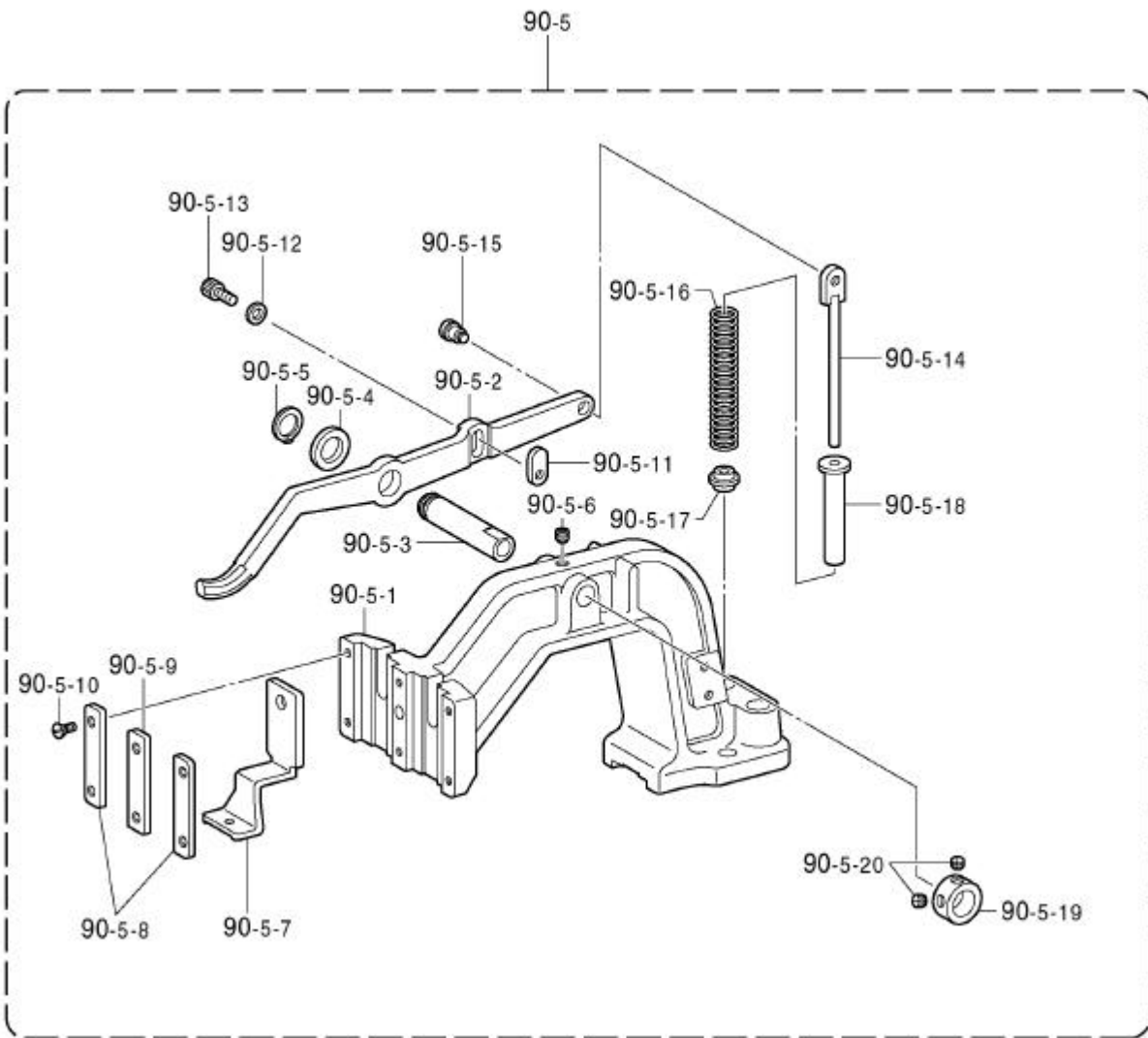







## Optional parts Feed mechanism

<For solenoid type>



Ref. No.	Part name	Part code	Q'ty
<b>&lt;For solenoid type&gt;</b>			
90-5	Work clamp arm assy, G	S42093-200	1
90-5-1	Work clamp arm	153364-000	1
90-5-2	Work clamp arm lever, L	S42089-001	1
90-5-3	Work clamp arm lever shaft	153367-001	1
90-5-4	Spacer	142628-001	1
90-5-5	Retaining ring, external C11	048110-142	1
90-5-6	Set screw, socket SM 5.95×5	152718-001	1
90-5-7	Work clamp, S	153368-001	1
90-5-8	Work clamp guide plate, A	153369-001	2
90-5-9	Work clamp guide plate, B	153370-001	1
90-5-10	Screw, flat SM3.57	107038-003	6
90-5-11	Work clamp arm lever plate	S52099-001	1
90-5-12	Washer	140407-002	1
90-5-13	Bolt, socket M5×8	018500-822	1
90-5-14	Spring guide rod	153570-001	1
90-5-15	Shoulder screw, socket SM4.76	145478-101	1
90-5-16	Spring, A compression	153568-001	1
90-5-17	Spacer	152788-000	1
90-5-18	Collar	153567-000	1
90-5-19	Set screw collar	146581-002	1
90-5-20	Set screw, SM5.95	100260-001	2

## Different parts list

Part name	Spec.	Medium materials	Heavy materials	Inner clamping device	Extra heavy materials
Needle hole plate 		(φ2.2) S49980-001 FM	(φ2.6) S10212-101 E	(φ2.2) S49980-001 FM	(φ2.6) S10212-101 E
Bobbin case assy 		159610-201 A	152690-301 B	159610-201 A	152690-301 B
		S15902-401 LA			
Tensionspring 		154339-001 A	154340-001 B	154339-001 A	154340-001 B
		S16074-101 LA			
Screw 		154341-001			
		S16492-101 LA			
Spring, anti-spin 		159612-001 A	154342-001 B	159612-001 A	154342-001 B
		S15667-001 LA			
Bobbin 		159613-051			154663-001 B
		S44633-001 LAN			
Shuttle hook assy w/box 		152685-903 A	152687-902 B	152685-903 A	152687-902 B
		S15662-992 LA	S15663-991 LB	S15662-992 LA	S15663-991 LB
Shuttle race body 		152682-101 A	152686-101 B	152682-101 A	152686-101 B
Tension spring 		104525-001	107606-001	104525-001	S06548-001 C
Thread take-up spring 		145519-001	144588-001 B	145519-001	144588-001 B
Needle bar thread guide  		S41222-101 B	152890-001 A	S41222-101 B	S02439-001 B

\*◎: Common with the LK3-B430E.

## Different parts list

Part name / Spec.	Medium materials	Heavy materials	Inner clamping device	Extra heavy materials
Needle assy	107415-414	S37928-419	145646-414	145646-425
Needle 	P × 5 #14 107415-014	DP × 17 NY #19 S37928-019	DP × 17 145646-014	DP × 17 145646-025
Work clamp blank 	434-1R S42030-001	434-2R S42032-001	154256-101 A	-
	434-1L S42031-001	434-2L S42033-001		
Feed plate blank 	434-1 S42034-001	434-2 S42035-001	434-R1 S43459-001	-

\*: Common with the LK3-B430E.

: Common with the BAS-311E.

## Gauge parts list



Optional gauges are listed in the following table.

Each work clamp pair is used in combination with the feed plate directly below them.

	1	2	3	4
R	153493-001	S23377-001 (519)	S27836-001 (895)	156085-001 (M)
L	153498-001	S23378-001 (519)	S27837-001 (895)	156086-001 (M)
Work clamp, 				
Feed plate	153503-001 	S23379-001 (519) 	S27838-001 (895) 	156087-001 (M) 

	5	6
R	156082-001 (L)	156088-001 (S)
L	156083-001 (L)	156089-001 (S)
Work clamp, 		
Feed plate	156084-001 (L) 	156090-001 (S) 

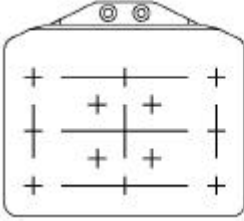
# Gauge parts list

Gauge assy, 434E MK2	
S54984-001	
Home position standard plate	Screw
	

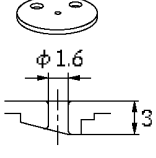
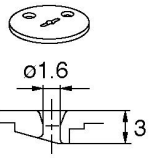
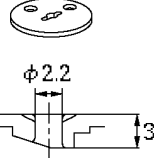
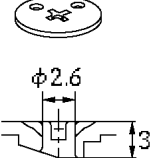
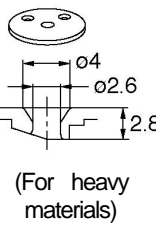
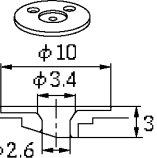
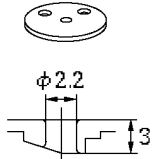
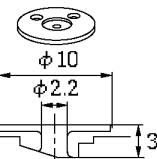
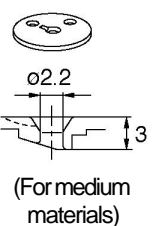
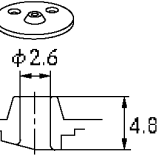
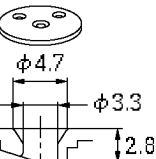
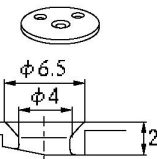
Needle hole plate											
A	S10211-001	AF	S51449-001	BZ	S41013-001	D	S29997-001	E	S10212-101	ED	S30925-001
											
F	S10213-001	FD	S30926-001	FM	S49980-001	H	S30450-001	L	S25127-001	M	S34348-001
											
3	S40217-001										
