

PFAFF

422

Unterklassen-Ausstattung

Subclass parts

Composition des sous-classes

Composición de las subclases

Erläuterungen Explanations

Légende Explicaciones

Die Liste enthält nur Nähwerkzeuge sowie unterklassenabhängige Teile. Beim Umbau in eine andere Unterklasse bzw. Ausführung können auch noch Maschinenteile erforderlich sein. Geben Sie also bei Bestellungen die genaue Bezeichnung der vorhandenen bzw. der gewünschten Ausführung an.

The list contains only gauge parts and subclass-dependent parts. For a conversion into another subclass or version machine parts may be required as well. Please state the exact classification of the existing or required version on your order.

La liste comprend uniquement des organes de couture et des pièces dépendant des sous-classes. En cas de transformation en une autre sous-classe ou une autre version, il se peut que d'autres pièces de machine soient nécessaires. C'est pourquoi nous vous prions d'indiquer, à la commande, la désignation exacte de la version existante ou souhaitée.

La lista contiene solamente órganos de costura y piezas dependientes de la subclase. En el caso de transformación en otra subclase o en otro tipo, es posible que sean necesarias piezas de la máquina. Al hacer los pedidos, indíquese la denominación exacta del tipo existente o del deseado.

- 3/1** Gesichert mit Loctite.
Secured with Loctite.
Bloqué par Loctite.
Asegurado con Loctite.
- 4** Ausführungsart bei Bestellung angeben.
Model to be stated on order.
Préciser le modèle à la commande.
Indíquese el tipo en los pedidos.
- 5** Nähmuster bzw. Material einsenden.
Submit sewing sample or material.
Joindre échantillons de couture ou matières.
Envíense muestras de costura.
- 10** Nadelabstand
Needle gauge
Écartement des aiguilles
Distancia entre agujas
- 10/1** Je nach Nadelabstand ändert sich die Form (z. B. beim Stoffschieber die Anzahl der Zahnreihen).
Certain design features change according to the needle gauge (e. g. the number of tooth rows on the feed dog).
La forme est fonction de l'écartement des aiguilles (par ex. le nombre des rangées de dents de la griffe).
La forma varia de acuerdo con la distancia entre agujas (p. e. el número de hileras de dientes en el transportador).
- 10/2** Nadelabstand bei Bestellung angeben.
Needle gauge to be stated on order.
Écartement des aiguilles; à préciser à la commande.
Indíquese en los pedidos la distancia entre agujas.

Erläuterungen
Explanations

Légende
Explicaciones

12 Absteppbreite
Stitching margin
Relarge de couture
Margen de costura

12/2 Absteppbreite bei Bestellung angeben.
Stitching margin to be stated on order.
Indiquer le relarge de couture à la commande.
Indíquese el margen de costura en los pedidos.

41/2 Nadeldiagonalabstand bei Bestellung angeben.
Please state diagonal needle distance on order.
Prière d'indiquer l'espacement diagonal des aiguilles à la commande.
Indíquese en los pedidos la distancia diagonal entre agujas.

- Mit -900/.. lieferbar (bis max. 8 mm Nadelabstand).
Can be supplied with -900/.. (up to a needle gauge of 8 mm).
Livrabable avec -900/.. (jusqu'à écartement des aiguilles de 8 mm).
Se puede suministrar con -900/.. (hasta distancias máx. entre agujas de 8 mm).
- Mit -900/.. lieferbar (bis max. Nadelabstand des angegebenen Bereichs, sofern dieser 24 mm nicht übersteigt).
Can be supplied with -900/.. (up to the maximum needle gauge of the range indicated, provided this does not exceed 24 mm).
Livrabable avec -900/.. (jusqu'à écartement max. des aiguilles, sans que celui-ci puisse dépasser 24 mm).
Se puede suministrar con -900/.. (hasta la distancia entre agujas máxima indicada como posible, siempre que ésta no pase de 24 mm).
- ▲ Befestigungsschraube 91-100 309-15 (1x) erforderlich.
Retaining screw 91-100 309-15 (1x) required.
Vis de fixation 91-100 309-15 (1x) nécessaire.
Es necesario el tornillo de fijación Nº 91-100 309-15 (1x).

Unterklassen-Übersicht
Table of subclasses

Table des sous-classes
Tabla de subclasses

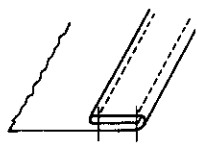
| Unterklasse Subclass Sous-classe Subclase | -6/01 (-900/..) ■ | -6/01 (-900/..) ■ | -6/02 (-900/..) ■ | -6/03 (-900/..) ■ | -19/01 (-900/..) ■ |
|--|--|--|--|--|---|
| Arbeitsgang Operation Opération Opéración | Für allgemeine Näharbeiten. Standardform des Teilesatzes. For ordinary sewing operations. Standard parts set. Travaux d'utilité courante. Jeu de pièces standard. Para trabajos de costura en general. Juego de piezas estándar. | Für allgemeine Näharbeiten. Standardform des Teilesatzes. For ordinary sewing operations. Standard parts set. Travaux d'utilité courante. Jeu de pièces standard. Para trabajos de costura en general. Juego de piezas estándar. | Wie -6/01, jedoch mit Brücken-Teilesatz. Same as -6/01, but with bridge type parts set. Comme la -6/01, mais jeu de pièces avec griffe pont. Como la -6/01, pero con juego de piezas en puente. | Wie -6/01, jedoch mit 2-teiligem Fuß. Same as -6/01, but with two-part foot. Comme la -6/01, mais avec pied en deux parties. Como la -6/01, pero con pie bipartido. |  |
| Ausführung Model Version Tipo de máquina | A; B | B/CN | A; B | A; B | B |
| Saumbreite in mm Hem width in mm Largeur de l'ourlet en mm Anchura del dobladillo en mm | | | | | 4,0 - 15,0 |
| Nadelabstand in mm Needle gauge in mm Ecartement des aiguilles en mm Distancia entre agujas en mm | 0,8 - 40,0 | 4,8 - 40,0 | 4,8 - 25,2 | 4,0 - 40,0 | 4,8 - 12,0 |
| Nadelhalter $\frac{10}{2}$ Needle holder Pince-aiguille Portaagujas | 91-176 343-93 x 2,4 $\frac{41}{2}$ $\frac{10}{10}$ = 0,8 - 2,2 mm 91-176 343-93 x 3,2 $\frac{41}{2}$ $\frac{10}{10}$ = 0,8 - 2,8 mm 91-176 068-93 $\frac{10}{10}$ = 2,4 - 4,0 mm 91-172 590-93 $\frac{10}{10}$ = 4,8 - 7,2 mm 91-172 840-93 $\frac{10}{10}$ = 8,0 - 15,2 mm 91-710 004-93 $\frac{10}{10}$ = 16,0 - 34,0 mm 91-710 234-93 $\frac{10}{10}$ = 36,0 - 40,0 mm | 91-710 004-93 $\frac{10}{10}$ = 4,8 - 34,0 mm 91-710 234-93 $\frac{10}{10}$ = 36,0 - 40,0 mm | 91-172 590-93 $\frac{10}{10}$ = 4,8 - 7,2 mm 91-172 840-93 $\frac{10}{10}$ = 8,0 - 15,2 mm 91-710 004-93 $\frac{10}{10}$ = 16,0 - 25,2 mm | 91-176 068-93 $\frac{10}{10}$ = 4,0 mm 91-172 590-93 $\frac{10}{10}$ = 4,8 - 7,2 mm 91-172 840-93 $\frac{10}{10}$ = 8,0 - 15,2 mm 91-710 004-93 $\frac{10}{10}$ = 16,0 - 34,0 mm 91-710 234-93 $\frac{10}{10}$ = 36,0 - 40,0 mm | 91-172 590-93 $\frac{10}{10}$ = 4,8 - 7,2 mm 91-172 840-93 $\frac{10}{10}$ = 8,0 - 12,0 mm |
| Stoffschieber $\frac{4}{10/2}$ Feed dog Griffe Transportador inferior | 91-059 661-04 x 2,4 $\frac{10}{10}$ = 0,8 - 2,2 mm 91-059 312-04 x 3,2 $\frac{10}{10}$ = 0,8 - 2,8 mm 91-059 313-04 $\frac{10/1}{10/1}$ $\frac{10}{10}$ = 2,4 - 40,0 mm | 91-059 313-04 $\frac{10/1}{10/1}$ | 91-059 824-04 $\frac{10/1}{10/1}$ | 91-059 313-04 $\frac{10/1}{10/1}$ | 91-059 313-04 $\frac{10/1}{10/1}$ |
| Stichplatte $\frac{4}{10/2}$ Needle plate Plaque à aiguille Placa de aguja | 91-150 121-05 x 2,4 $\frac{10}{10}$ = 0,8 - 2,2 mm 91-150 122-05 x 3,2 $\frac{10}{10}$ = 0,8 - 2,8 mm 91-150 123-04 $\frac{10/1}{10/1}$ $\frac{10}{10}$ = 2,4 - 40,0 mm | 91-150 120-04 $\frac{10/1}{10/1}$ | 91-150 321-04 $\frac{10/1}{10/1}$ | 91-150 123-04 $\frac{10/1}{10/1}$ | 91-150 123-04 $\frac{10/1}{10/1}$ |
| Nähfuß $\frac{4}{10/2}$ Presser foot Pied presseur Pie prensatelas | 91-054 922-03 $\frac{10}{10}$ = 0,8 - 4,0 mm 91-155 752-03 $\frac{10}{10}$ = 4,8 - 14,0 mm 91-155 753-03 $\frac{10}{10}$ = 15,2 - 40,0 mm | 91-054 926-03 $\frac{10}{10}$ = 4,8 - 14,0 mm 91-054 927-03 $\frac{10}{10}$ = 15,2 - 40,0 mm | 91-155 752-03 $\frac{10}{10}$ = 4,8 - 14,0 mm 91-155 753-03 $\frac{10}{10}$ = 15,2 - 25,2 mm | 91-055 499-93 $\frac{10}{10}$ = 4,0 - 11,2 mm 91-055 506-93 $\frac{10}{10}$ = 12,0 - 22,0 mm 91-055 507-93 $\frac{10}{10}$ = 24,0 - 40,0 mm | 91-055 609-03 |
| Apparat $\frac{5}{10/2}$ Attachment Appareil Aparato | | | | | 91-041 006-23 |
| Träger Bracket Support Soporte | | | | | 91-753 936-90 |

Unterklassen-Übersicht
Table of subclasses

Table des sous-classes
Tabla de subclasses

| Unterklasse Subclass Sous-classe Subclase | -40/35 | -42/03 | -57/01 (-900/..) ■ | -58/01 (-900/..) ■ | -61/01 (-900/..) ■ |
|--|------------------------------------|------------------------------------|---|---|---|
| Arbeitsgang Operation Opération Operación | | | | | |
| Ausführung Model Version Tipo de máquina | AN 2,5; BN 2,5 | AN 2,5; BN 2,5 | B | B | A; B |
| Nadelabstand in mm Needle gauge in mm Ecartement des aiguilles en mm Distancia entre agujas en mm | 1,6 | 1,6 | 4,0 - 10,0 | 4,0 - 10,0 | 2,4 - 20,0 |
| Nadelhalter $\boxed{10/2}$ Needle holder Pince-aiguille Portaagujas | 91-176 343-93 x 3,2 $\boxed{41/2}$ | 91-176 343-93 x 3,2 $\boxed{41/2}$ | 91-176 068-93 $\boxed{10}$ = 4,0 mm 91-172 590-93 $\boxed{10}$ = 4,8 - 7,2 mm 91-172 840-93 $\boxed{10}$ = 8,0 - 10,0 mm | 91-176 068-93 $\boxed{10}$ = 4,0 mm 91-172 590-93 $\boxed{10}$ = 4,8 - 7,2 mm 91-172 840-93 $\boxed{10}$ = 8,0 - 10,0 mm | 91-176 068-93 $\boxed{10}$ = 2,4 - 4,0 mm 91-172 590-93 $\boxed{10}$ = 4,8 - 7,2 mm 91-172 840-93 $\boxed{10}$ = 8,0 - 15,2 mm 91-710 004-93 $\boxed{10}$ = 16,0 - 20,0 mm |
| Stoffschieber $\boxed{4}$ $\boxed{10/2}$ Feed dog Griffe Transportador inferior | 91-059 826-04 | 91-059 826-04 | 91-059 313-04 $\boxed{10/1}$ | 91-059 313-04 $\boxed{10/1}$ | 91-059 313-04 $\boxed{10/1}$ |
| Stichplatte $\boxed{4}$ $\boxed{10/2}$ Needle plate Plaque à aiguille Placa de aguja | 91-150 327-04 | 91-150 327-04 | 91-150 123-04 $\boxed{10/1}$ | 91-150 123-04 $\boxed{10/1}$ | 91-150 123-04 $\boxed{10/1}$ |
| Nähfuß $\boxed{4}$ $\boxed{10/2}$ Presser foot Pied presseur Pie prensateelas | 91-057 625-03 | 91-055 296-03 | 91-054 922-03 $\boxed{10}$ = 4,0 mm 91-155 752-03 $\boxed{10}$ = 4,8 - 10,0 mm | 91-054 922-03 $\boxed{10}$ = 4,0 mm 91-155 752-03 $\boxed{10}$ = 4,8 - 10,0 mm | 91-157 658-03 $\boxed{5}$ $\boxed{10}$ = 2,4 - 14,0 mm 91-157 730-03 $\boxed{5}$ $\boxed{10}$ = 15,2 - 20,0 mm |
| Apparat $\boxed{5}$ $\boxed{10/2}$ Attachment Appareil Aparato | 91-492 567-23 | 91-050 546-93 | 91-040 317-93 | 91-040 316-93 | |
| Träger Bracket Support Soporte | 91-753 936-90 | | | | |
| Kopfplatte Face plate Plaque frontale Placa frontal | | | | | 91-166-296-72/993 |
| Bandtrommel Tape reel Tambour-dérouleur Tambor portacintas | | | | | 91-040 207-70/995 |

Unterklassen-Übersicht
Table of subclasses

Table des sous-classes
Tabla de subclasses

| Unterklasse Subclass Sous-classe Subclase | -63/01 | -69/01 (-900/..) | -69/02 (-900/..) | -69/12 (-900/..) | -70/01 (-900/..) |
|--|--|---|---|---|--|
| Arbeitsgang Operation Opération Operación | | | | | |
| Ausführung Model Version Tipo de máquina | B | AN 2,5; BN 2,5 | A; B | A; B | A; B |
| Nadelabstand in mm Needle gauge in mm Ecartement des aiguilles en mm Distancia entre agujas en mm | 4,8 - 18,0 | 2,4 - 20,0 | 3,2 - 20,0 | 3,2 - 20,0 | 4,8 - 20,0 |
| Nadelhalter Needle holder Pince-aiguille Portaagujas | 91-172 590-93 = 4,8 - 7,2 mm 91-172 840-93 = 8,0 - 15,2 mm 91-710 004-93 = 16,0 - 18,0 mm | 91-176 068-93 = 2,4 - 4,0 mm 91-172 590-93 = 4,8 - 7,2 mm 91-172 840-93 = 8,0 - 15,2 mm 91-710 004-93 = 16,0 - 20,0 mm | 91-176 068-93 = 3,2 - 4,0 mm 91-172 590-93 = 4,8 - 7,2 mm 91-172 840-93 = 8,0 - 15,2 mm 91-710 004-93 = 16,0 - 20,0 mm | 91-176 068-93 = 3,2 - 4,0 mm 91-172 590-93 = 4,8 - 7,2 mm 91-172 840-93 = 8,0 - 15,2 mm 91-710 004-93 = 16,0 - 20,0 mm | 91-172 590-93 = 4,8 - 7,2 mm 91-172 840-93 = 8,0 - 15,2 mm 91-710 004-93 = 16,0 - 20,0 mm |
| Stoffschieber Feed dog Griffe Transportador inferior | 91-047 811-04 | 91-059 313-04 | 91-059 313-04 | 91-059 313-04 | 91-059 313-04 |
| Stichplatte Needle plate Plaque à aiguille Placa de aguja | 91-150 331-93 ▲ | 91-150 126-04 | 91-150 123-04 | 91-150 123-04 | 91-150 123-04 |
| Nähfuß Presser foot Pied presseur Pie prensateelas | 91-055 597-03 = 4,8 - 14,0 mm 91-055 600-03 = 15,2 - 18,0 mm | 91-057 040-03 | 91-054 922-03 = 3,2 - 4,0 mm 91-155 752-03 = 4,8 - 14,0 mm 91-155 753-03 = 15,2 - 20,0 mm | 91-055 570-03 | 91-054 926-03 = 4,8 - 14,0 mm 91-054 927-03 = 15,2 - 20,0 mm |
| Apparat Attachment Appareil Aparato | | | 91-050 972-93 | 91-050 972-93 | 91-026 588-23 |
| Kopfplatte Face plate Plaque frontale Placa frontal | | 91-166 296-72/993 | 91-166 296-72/993 | 91-166 296-72/993 | |
| Bandtrommel Tape reel Tambour-dérouleur Tambor portacintas | 91-041 644-70/995 | 91-040 207-70/995 | 91-040 207-70/995 | 91-040 207-70/995 | 91-041 644-70/995 |

Unterklassen-Übersicht
Table of subclasses

Table des sous-classes
Tabla de subclasses

| Unterklasse Subclass Sous-classe Subclase | -70/02 (-900/..) | -83/01 (-900/..) | -83/21 | -99/01 | -111/01 |
|--|---|-------------------|--|---|---|
| Arbeitsgang Operation Opération Operación | | | | | |
| Ausführung Model Version Tipo de máquina | A; B | AN 2,5; BN 2,5 | AN 2,5; BN 2,5 | AN 2,5; BN 2,5 | AN 2,5; BN 2,5 |
| Nadelabstand in mm Needle gauge in mm Ecartement des aiguilles en mm Distancia entre agujas en mm | 4,8 - 20,0 | 4,8 + 7,2 | 3,2 - 8,0 | 4,8 - 10,0 | 4,8 - 10,0 |
| Nadelhalter $\boxed{10/2}$ Needle holder Pince-aiguille Portaagujas | 91-172 590-93 $\boxed{10}$ = 4,8 - 7,2 mm 91-172 840-93 $\boxed{10}$ = 8,0 - 15,2 mm 91-710 004-93 $\boxed{10}$ = 16,0 - 20,0 mm | 91-172 590-93 | 91-176 068-93 $\boxed{10}$ = 3,2 - 4,0 mm 91-172 590-93 $\boxed{10}$ = 4,8 - 7,2 mm 91-172 840-93 $\boxed{10}$ = 8,0 mm | 91-172 590-93 $\boxed{10}$ = 4,8 - 7,2 mm 91-172 840-93 $\boxed{10}$ = 8,0 - 10,0 mm | 91-172 590-93 $\boxed{10}$ = 4,8 - 7,2 mm 91-172 840-93 $\boxed{10}$ = 8,0 - 10,0 mm |
| Stoffschieber $\boxed{4}$ $\boxed{10/2}$ Feed dog Griffe Transportador inferior | 91-059 313-04 $\boxed{10/1}$ | 91-059 827-04 | 91-047 695-04 $\boxed{10}$ = 3,2 mm AN 2,5 $\boxed{10}$ = 3,6 - 8,0 mm AN 2,5; BN 2,5 | 91-059 822-04 | 91-059 822-04 |
| Stichplatte $\boxed{4}$ $\boxed{10/2}$ Needle plate Plaque à aiguille Placa de aguja | 91-150 123-04 $\boxed{10/1}$ | 91-150 317-04 ▲ | 91-150 466-04 ▲ | 91-150 317-04 ▲ | 91-150 317-04 ▲ |
| Nähfuß $\boxed{4}$ $\boxed{10/2}$ Presser foot Pied presseur Pie prensateelas | 91-054 926-03 $\boxed{10}$ = 4,8 - 14,0 mm 91-054 927-03 $\boxed{10}$ = 15,2 - 20,0 mm | 91-055 211-03 | 91-055 167-03 | 91-055 211-03 | 91-055 211-03 |
| Apparat $\boxed{5}$ $\boxed{10/2}$ Attachment Appareil Aparato | 91-044 734-23 | 91-050 002-23 | 91-050 002-23 | 91-056 279-73 | 91-050 905-73 |
| Träger Bracket Support Soporte | 91-753 936-90 | | | | |
| Bandtrommel Tape reel Tambour-dérouleur Tambor portacintas | 91-041 644-70/995 | 91-041 644-70/995 | 91-041 644-70/995 | 91-041 644-70/995 | 91-156 005-71/995 |
| Bandführung Tape guide Guide-ruban Guiacintas | | 91-044 419-25 | 91-044 419-25 | 91-044 419-25 | 91-044 419-25 |

Unterklassen-Übersicht
Table of subclasses

Table des sous-classes
Tabla de subclasses

| Unterklasse Subclass Sous-classe Subclass | -111/11 | -113/02 (-900/..) ■ | -113/03 (-900/..) ● | -303/11 (-900/..) ■ | -307/01 |
|--|--|--|--|---|---|
| Arbeitsgang Operation Opération Operación | | | | | |
| Ausführung Model Version Tipo de máquina | AN 2,5; BN 2,5 | B | B | B | BN 2,5 |
| Nadelabstand in mm Needle gauge in mm Ecartement des aiguilles en mm Distancia entre agujas en mm | 4,8 - 10,0 | 2,4 - 13,2 | 2,4 - 13,2 | 10,0 + 12,0 | 4,8 - 10,0 |
| Nadelhalter ^{10/2} Needle holder Pince-aiguille Portaagujas | 91-172 590-93 ¹⁰ = 4,8 - 7,2 mm 91-172 840-93 ¹⁰ = 8,0 mm | 91-176 068-93 ¹⁰ = 2,4 - 4,0 mm 91-172 590-93 ¹⁰ = 4,8 - 7,2 mm 91-172 840-93 ¹⁰ = 8,0 - 13,2 mm | 91-176 068-93 ¹⁰ = 2,4 - 4,0 mm 91-172 590-93 ¹⁰ = 4,8 - 7,2 mm 91-172 840-93 ¹⁰ = 8,0 - 13,2 mm | 91-172 840-93 | 91-172 590-93 ¹⁰ = 4,8 - 7,2 mm 91-172 840-93 ¹⁰ = 8,0 - 10,0 mm |
| Stoffschieber ⁴ ^{10/2} Feed dog Griffe Transportador inferior | 91-059 822-04 | 91-059 785-04 ^{10/1} | 91-059 444-04 ^{10/1} | 91-059 313-04 | 91-047 753-04 |
| Stichplatte ⁴ Needle plate Plaque à aiguille Placa de aguja | 91-150 317-04 ▲ | 91-150 196-04 ^{10/1} ^{12/2} ¹² = 1,5 - 3,5 mm | 91-150 196-04 ^{10/1} ^{12/2} ¹² = 1,5 - 3,5 mm | 91-150 123-04 | 91-150 318-03 ▲ |
| Nähfuß ⁴ ^{10/2} Presser foot Pied presseur Pie prensatelas | 91-055 211-03 | 91-155 902-03 ^{12/2} ¹⁰ = 2,4 - 2,8 mm ¹² = 1,5 mm; 2,0 mm ¹⁰ = 3,2 - 13,2 mm ¹² = 1,5 mm | 91-155 927-03 ^{12/2} ¹⁰ = 2,4 - 2,8 mm ¹² = 1,5 mm; 2,0 mm ¹⁰ = 3,2 - 13,2 mm ¹² = 1,5 mm | 91-057 586-03 ⁵ | 91-055 486-03 ⁵ |
| Apparat ⁵ ^{10/2} Attachment Appareil Aparato | 91-050 982-73 | | | | 91-050 972-93 91-050 981-73 |
| Kopfplatte Face plate Plaque frontale Placa frontal | | | | 91-166 296-72/993 | 91-166 296-72/993 |
| Bandtrommel Tape reel Tambour-dérouleur Tambor portacintas | 91-156 005-71/995 | | | | 91-056 161-70/995 91-156 005-71/995 |
| Bandführung Tape guide Guide-ruban Guiacintas | 91-044 419-25 | | | 91-056 517-91 91-056 526-21 91-056 536-25 | 91-050 909-21 |
| Bandrollenträger Tape reel bracket Plateau dérouleur Portarrollos | | | | 91-056 532-71/995 | |
| Führung Guide Guide Guía | | | | 91-056 514-21 | |

Unterklassen-Übersicht
Table of subclasses

Table des sous-classes
Tabla de subclasses

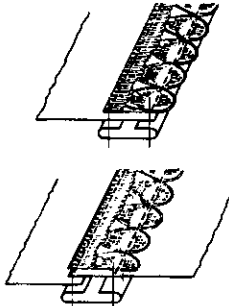
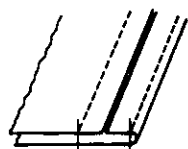
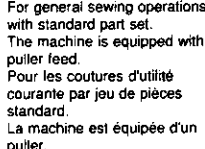
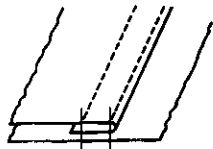
| Unterklasse Subclass Sous-classe Subclase | -313/01 | -396/02 (-900/..) ■ | -748/26-6/01 (-900/..) ■ | -748/26-113/02 (-900/..) ■ |
|--|---|---|--|---|
| Arbeitsgang Operation Opération Operación |  |  |  |  |
| Ausführung Model Version Tipo de máquina | AN 2,5; BN 2,5 | A; B | A; B | B |
| Nadelabstand in mm Needle gauge in mm Ecartement des aiguilles en mm Distancia entre agujas en mm | 4,8 - 10,0 | 4,8 - 15,2 | 4,0 - 14,0 | 2,4 - 13,2 |
| Nadelhalter ^{10/2} Needle holder Pince-aiguille Portaagujas | 91-172 590-93 ¹⁰ = 4,8 - 7,2 mm 91-172 840-93 ¹⁰ = 8,0 - 10,0 mm | 91-172 590-93 ¹⁰ = 4,8 - 7,2 mm 91-172 840-93 ¹⁰ = 8,0 - 15,2 mm | 91-176 068-93 ¹⁰ = 4,0 mm 91-172 590-93 ¹⁰ = 4,8 - 7,2 mm 91-172 840-93 ¹⁰ = 8,0 - 14,0 mm | 91-176 068-93 ¹⁰ = 2,4 - 4,0 mm 91-172 590-93 ¹⁰ = 4,8 - 7,2 mm 91-172 840-93 ¹⁰ = 8,0 - 13,2 mm |
| Stoffschieber ⁴ Feed dog Griffe Transportador inferior | 91-059 822-04 | 91-059 313-04 ^{10/1} | 91-059 313-04 ^{10/1} | 91-059 785-04 ^{10/1} |
| Stichplatte ⁴ Needle plate Plaque à aiguille Placa de aguja | 91-150 317-04 ▲ | 91-150 123-04 ^{10/1} | 91-150 123-04 ^{10/1} | 91-150 196-04 ^{10/1} ^{12/2} ¹² = 1,5 - 3,5 mm |
| Nähfuß ⁴ ^{10/2} Presser foot Pied presseur Pie prensatelas | 91-057 860-93 | 91-055 609-03 ¹⁰ = 4,8 - 14,0 mm 91-055 611-03 ¹⁰ = 15,2 mm | 91-460 804-03 | 91-155 906-03 ^{12/2} ¹⁰ = 2,4 - 2,8 mm ¹² = 1,5 mm; 2,0 mm 91-155 882-03 ^{12/2} ¹⁰ = 3,2 - 13,2 mm ¹² = 1,5 mm 91-155 882-03 ^{12/2} ¹⁰ = 3,2 - 13,2 mm ¹² = 2,0 - 3,5 mm |
| Apparat ⁵ ^{10/2} Attachment Appareil Aparato | 91-056 704-23 | 91-056 478-93 | | |
| Träger Bracket Support Soporte | | 91-753 936-90 | | |
| Kopfplatte Face plate Plaque frontale Placa frontal | 91-166 296-72/993 | | | |
| Bandtrommel Tape reel Tambour-dérouleur Tambor portacintas | 91-040 207-70/995 91-041 644-70/995 | | | |

Für allgemeine Näharbeiten
mittels Standardteilesatz. Die
Maschine ist mit Walzen-
transport-Einrichtung
ausgestattet.
For general sewing operations
with standard part set.
The machine is equipped with
puller feed.
Pour les coutures d'utilité
courante par jeu de pièces
standard.
La machine est équipée d'un
puller.
Para trabajos de costura en
general mediante juego de
piezas estándar. La máquina
va equipada con un puller.

**Nähwerkzeuge
Gauge parts**

**Organes de couture
Organos de costura**

91-172 590-93 $\overline{10/2}$
 $\overline{10}$ = 4,8 - 7,2 mm

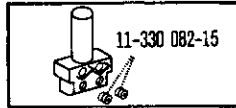

- 57/01 (-900/..)
- 58/01 (-900/..)
- 61/01 (-900/..)
- 63/01
- 69/01 (-900/..)
- 69/02 (-900/..)
- 69/12 (-900/..)
- 70/01 (-900/..)
- 70/02 (-900/..)
- 83/01 (-900/..)
- 83/21
- 99/01
- 111/01
- 111/11
- 113/02 (-900/..)
- 113/03 (-900/..)
- 307/01
- 313/01
- 396/02 (-900/..)
- 748/26-6/01 (-900/..)
- 748/26-113/02 (-900/..)

- 6/01 (-900/..)
- 6/02 (-900/..)
- 6/03 (-900/..)
- 19/01 (-900/..)

91-172 840-93 $\overline{10/2}$
 $\overline{10}$ = 8,0 - 15,2 mm

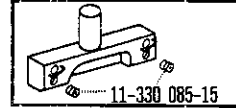

- 57/01 (-900/..)
- 58/01 (-900/..)
- 61/01 (-900/..)
- 63/01
- 69/01 (-900/..)
- 69/02 (-900/..)
- 69/12 (-900/..)
- 70/01 (-900/..)
- 70/02 (-900/..)
- 83/21
- 99/01
- 111/01
- 111/11
- 113/02 (-900/..)
- 113/03 (-900/..)
- 303/11 (-900/..)
- 307/01
- 313/01
- 396/02 (-900/..)
- 748/26-6/01 (-900/..)
- 748/26-113/02 (-900/..)

- 6/01 (-900/..)
- 6/02 (-900/..)
- 6/03 (-900/..)
- 19/01 (-900/..)

91-176 068-93 $\overline{10/2}$
 $\overline{10}$ = 2,4 - 4,0 mm

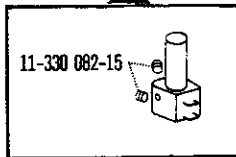

- 6/01 (-900/..)
- 6/03 (-900/..)
- 57/01 (-900/..)
- 58/01 (-900/..)
- 61/01 (-900/..)
- 69/01 (-900/..)
- 69/02 (-900/..)
- 69/12 (-900/..)
- 83/21
- 113/02 (-900/..)
- 113/03 (-900/..)
- 748/26-6/01 (-900/..)
- 748/26-113/02 (-900/..)

- 6/01 (-900/..)
- 40/35
- 42/03

91-176 343-93 x 2,4 $\overline{10/2}$ $\overline{41/2}$
 $\overline{10}$ = 0,8 - 2,2 mm
91-176 343-93 x 3,2 $\overline{10/2}$ $\overline{41/2}$
 $\overline{10}$ = 0,8 - 2,8 mm

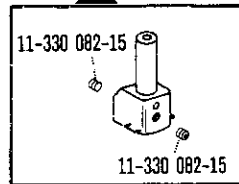

11-330 082-15
11-330 082-15

91-710 004-93 $\overline{10/2}$
 $\overline{10}$ = 4,8 - 34,0 mm

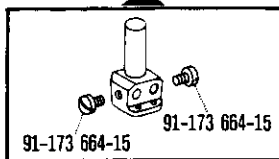

- 6/01 (-900/..)
- 6/02 (-900/..)
- 6/03 (-900/..)
- 61/01 (-900/..)
- 63/01
- 69/01 (-900/..)
- 69/02 (-900/..)
- 69/12 (-900/..)
- 70/01 (-900/..)
- 70/02 (-900/..)

91-710 234-93 $\overline{10/2}$
 $\overline{10}$ = 36,0 - 40,0 mm

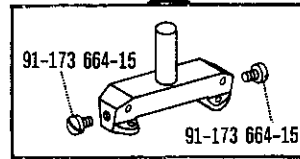











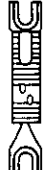
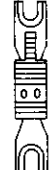



91-173 664-15
91-173 664-15

- 6/01 (-900/..)
- 6/03 (-900/..)



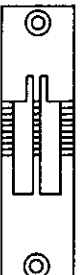

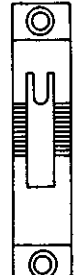







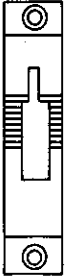
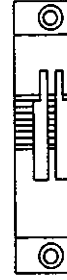

Nähwerkzeuge
Gauge parts

Organes de couture
Organos de costura

| | | | | |
|--|---|--|---|--|
| <p>91-047 695-04 [4] [10/2] $\overline{10}$ = 3,2 mm AN 2,5 $\overline{10}$ = 3,6 - 8,0 mm AN 2,5; BN 2,5</p>  <p>-83/21</p> | <p>91-047 753-04 [4] [10/2] $\overline{10}$ = 4,8 - 10,0 mm</p>  <p>-307/01</p> | <p>91-047 811-04 [4] [10/1] [10/2] $\overline{10}$ = 4,8 - 18,0 mm</p>  <p>-63/01</p> | <p>91-059 312-04 x 3,2 [4] [10/2] $\overline{10}$ = 0,8 - 2,8 mm [41/2]</p>  <p>-6/01 (-900/..)</p> | <p>91-059 313-04 [4] [10/2] $\overline{10}$ = 2,4 - 4,0 mm</p>  <p>-6/01 (-900/..) -6/03 (-900/..) -57/01 (-900/..) -58/01 (-900/..) -61/01 (-900/..) -69/01 (-900/..) -69/02 (-900/..) -69/12 (-900/..) -748/26-6/01 (-900/..)</p> |
| <p>91-059 313-04 [4] [10/1] [10/2] $\overline{10}$ = 4,8 - 40,0 mm</p>  | <p>-6/01 (-900/..) -6/03 (-900/..) -19/01 (-900/..) -57/01 (-900/..) -58/01 (-900/..) -61/01 (-900/..) -69/01 (-900/..) -69/02 (-900/..) -69/12 (-900/..) -70/01 (-900/..) -70/02 (-900/..) -303/11 (-900/..) -396/02 (-900/..) -748/26-6/01 (-900/..)</p> | <p>91-059 444-04 [4] [10/2] $\overline{10}$ = 2,4 - 4,0 mm</p>  <p>-113/03 (-900/..)</p> | <p>91-059 444-04 [4] [10/1] [10/2] $\overline{10}$ = 4,8 - 13,2 mm</p>  <p>-113/03 (-900/..)</p> | <p>91-059 661-04 x 2,4 [4] [10/2] $\overline{10}$ = 0,8 - 2,2 mm [41/2]</p>  <p>-6/01 (-900/..)</p> |
| <p>91-059 785-04 [4] [10/2] $\overline{10}$ = 2,4 - 4,0 mm</p>  <p>-113/02 (-900/..) -748/26-113/02 (-900/..)</p> | <p>91-059 785-04 [4] [10/1] [10/2] $\overline{10}$ = 4,8 - 13,2 mm</p>  <p>-113/02 (-900/..) -748/26-113/02 (-900/..)</p> | <p>91-059 822-04 [4] [10/2] $\overline{10}$ = 4,8 - 10,0 mm</p>  <p>-99/01 -111/01 -111/11 -313/01</p> | <p>91-059 824-04 [4] [10/1] [10/2] $\overline{10}$ = 4,8 - 25,2 mm</p>  <p>-6/02 (-900/..)</p> | <p>91-059 826-04 [4] [10/2] $\overline{10}$ = 1,6 mm</p>  <p>-40/35 -42/03</p> |
| <p>91-059 827-04 [4] [10/2] $\overline{10}$ = 4,8 + 7,2 mm</p>  <p>-83/01 (-900/..)</p> | | <p>91-150 120-04 [4] [10/1] [10/2] $\overline{10}$ = 4,8 - 40,0 mm</p>  <p>-6/01 (-900/..)</p> | <p>91-150 121-05 x 2,4 [4] [10/2] $\overline{10}$ = 0,8 - 2,2 mm</p>  <p>-6/01 (-900/..)</p> | <p>91-150 122-05 x 3,2 [4] [10/2] $\overline{10}$ = 0,8 - 2,8 mm</p>  <p>-6/01 (-900/..)</p> |

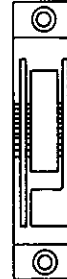
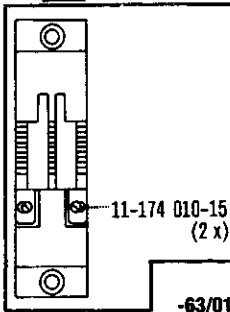
Nähwerkzeuge
Gauge parts

Organes de couture
Organos de costura

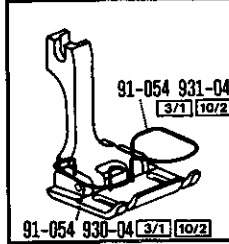
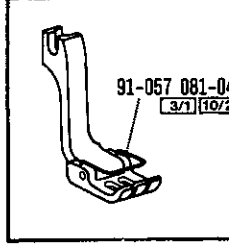
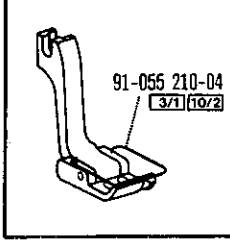
| | | | | |
|--|---|---|--|--|
| <p>91-150 123-04 [4] [10/2] [10] = 2,4 - 4,0 mm</p>  <p>-6/01 (-900/..) -6/03 (-900/..) -57/01 (-900/..) -58/01 (-900/..) -61/01 (-900/..) -69/02 (-900/..) -69/12 (-900/..) -748/26-6/01 (-900/..)</p> | <p>91-150 123-04 [4] [10/1] [10/2] [10] = 4,8 - 40,0 mm</p>  <p>-6/01 (-900/..) -6/03 (-900/..) -19/01 (-900/..) -57/01 (-900/..) -58/01 (-900/..) -61/01 (-900/..) -69/02 (-900/..) -69/12 (-900/..) -70/01 (-900/..) -70/02 (-900/..) -303/11 (-900/..) -396/02 (-900/..) -748/26-6/01 (-900/..)</p> | <p>91-150 126-04 [4] [10/2] [10] = 2,4 - 4,0 mm</p>  <p>-69/01 (-900/..)</p> | <p>91-150 126-04 [4] [10/1] [10/2] [10] = 4,8 - 20,0 mm</p>  <p>-69/01 (-900/..)</p> | |
| <p>91-150 195-04 [4] [10/2] [12/2] [10] = 2,4 - 4,0 mm [12] = 1,5 - 3,5 mm</p>  <p>-113/03 (-900/..)</p> | <p>91-150 195-04 [4] [10/1] [10/2] [10] = 4,8 - 13,2 mm [12] = 1,5 - 3,5 mm</p>  <p>-113/03 (-900/..)</p> | <p>91-150 196-04 [4] [10/2] [12/2] [10] = 2,4 - 4,0 mm [12] = 1,5 - 3,5 mm</p>  <p>-113/02 (-900/..) -748/26-113/02 (-900/..)</p> | <p>91-150 196-04 [4] [10/1] [10/2] [10] = 4,8 - 13,2 mm [12] = 1,5 - 3,5 mm</p>  <p>-113/02 (-900/..) -748/26-113/02 (-900/..)</p> | <p>91-150 317-04 [4] [10/2] [10] = 4,8 - 10,0 mm</p>  <p>-83/01 (-900/..) -99/01 -111/01 -111/11 -313/01</p> |
| <p>91-150 318-03 [4] [10/2] [10] = 4,8 - 10,0 mm</p>  <p>-307/01</p> | <p>91-150 321-04 [4] [10/1] [10/2] [10] = 4,8 - 25,2 mm</p>  <p>-6/02 (-900/..)</p> | <p>91-150 327-04 [4] [10/2] [10] = 1,6 mm</p>  <p>-40/35 -42/03</p> | <p>91-150 331-93 [4] [10/1] [10/2] [10] = 4,8 - 18,0 mm</p>  <p>11-174 010-15 (2 x) -63/01</p> | <p>91-150 466-04 [4] [10/2] [10] = 3,2 - 8,0 mm</p>  <p>-83/21</p> |
| <p>91-054 922-03 [4] [10/2]</p>  <p>91-054 925-05 [3/1]</p> <p>-6/01 (-900/..) -57/01 (-900/..) -58/01 (-900/..) -69/02 (-900/..)</p> | <p>91-054 926-03 [4] [10/2]</p>  <p>91-054 929-04 [3/1] [10/2]</p> <p>-6/01 (-900/..) -70/01 (-900/..) -70/02 (-900/..)</p> | <p>91-054 927-03 [4] [10/2]</p>  <p>91-054 931-04 [3/1] [10/2]</p> <p>91-054 930-04 [3/1] [10/2]</p> <p>-6/01 (-900/..) -70/01 (-900/..) -70/02 (-900/..)</p> | <p>91-055 167-03 [4] [10/2]</p>  <p>91-057 081-04 [3/1] [10/2]</p> <p>-83/21</p> | <p>91-055 211-03 [4] [10/2]</p>  <p>91-055 210-04 [3/1] [10/2]</p> <p>-83/01 (-900/..) -99/01 -111/01 -111/11</p> |



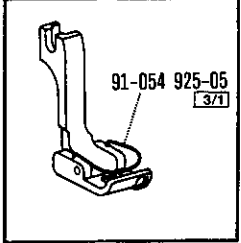
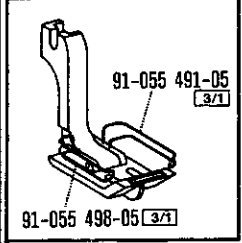
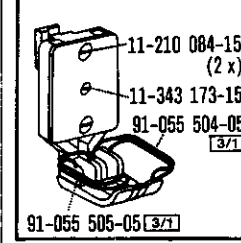
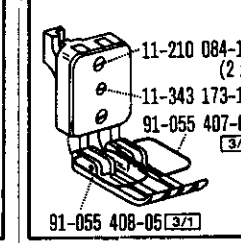
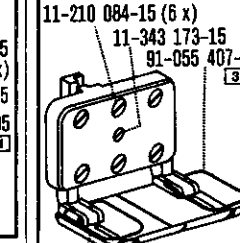
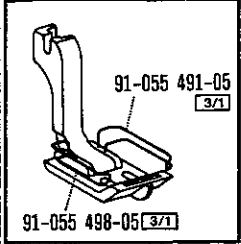
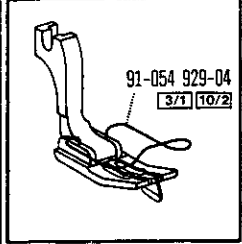
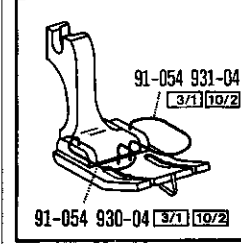
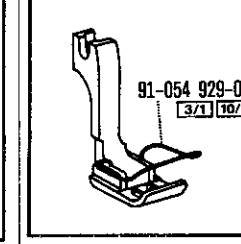
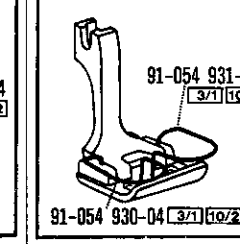
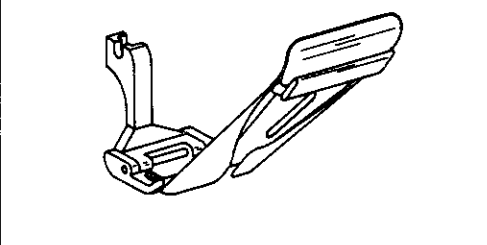
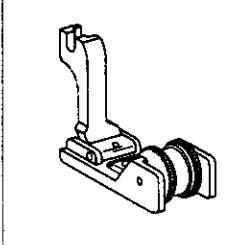
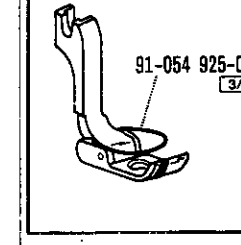
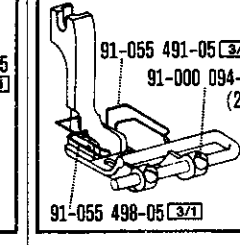
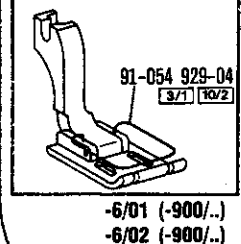
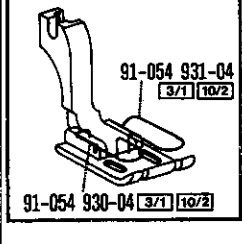
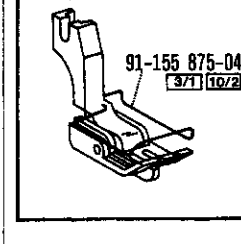
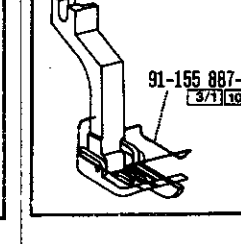
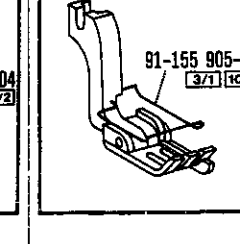

Nähwerkzeuge
Gauge parts

Organes de couture
Organos de costura

| | | | | |
|---|---|--|---|--|
| <p>91-055 296-03 [4] [10/2]</p>  <p>91-054 925-05 [3/1]</p> <p>-42/03</p> | <p>91-055 486-03 [4] [5] [10/2]</p>  <p>91-055 491-05 [3/1]</p> <p>91-055 498-05 [3/1]</p> <p>-307/01</p> | <p>91-055 499-93 [4] [10/2]</p>  <p>11-210 084-15 (2 x)</p> <p>11-343 173-15</p> <p>91-055 504-05 [3/1]</p> <p>91-055 505-05 [3/1]</p> <p>-6/03 (-900/..)</p> | <p>91-055 506-93 [4] [10/2]</p>  <p>11-210 084-15 (2 x)</p> <p>11-343 173-15</p> <p>91-055 407-05 [3/1]</p> <p>91-055 408-05 [3/1]</p> <p>-6/03 (-900/..)</p> | <p>91-055 507-93 [4] [10/2]</p>  <p>11-210 084-15 (6 x)</p> <p>11-343 173-15</p> <p>91-055 407-05 [3/1]</p> <p>91-055 408-05 [3/1]</p> <p>-6/03 (-900/..)</p> |
| <p>91-055 570-03 [4] [5] [10/2]</p>  <p>91-055 491-05 [3/1]</p> <p>91-055 498-05 [3/1]</p> <p>-69/12 (-900/..)</p> | <p>91-055 597-03 [4] [10/2]</p>  <p>91-054 929-04 [3/1] [10/2]</p> <p>-63/01</p> | <p>91-055 600-03 [4] [10/2]</p>  <p>91-054 931-04 [3/1] [10/2]</p> <p>91-054 930-04 [3/1] [10/2]</p> <p>-63/01</p> | <p>91-055 609-03 [4] [10/2]</p>  <p>91-054 929-04 [3/1] [10/2]</p> <p>-19/01 (-900/..) -396/02 (-900/..)</p> | <p>91-055 611-03 [4] [10/2]</p>  <p>91-054 931-04 [3/1] [10/2]</p> <p>91-054 930-04 [3/1] [10/2]</p> <p>-396/02 (-900/..)</p> |
| <p>91-057 040-03 [4] [5] [10/2]</p>  <p>-69/01 (-900/..)</p> | | <p>91-057 586-03 [4] [5] [10/2]</p>  <p>-303/11 (-900/..)</p> | <p>91-057 625-03 [4] [10/2]</p>  <p>91-054 925-05 [3/1]</p> <p>-40/35</p> | <p>91-057 860-93 [4] [10/2]</p>  <p>91-055 491-05 [3/1]</p> <p>91-000 094-25 (2 x)</p> <p>91-055 498-05 [3/1]</p> <p>-313/01</p> |
| <p>91-155 752-03 [4] [10/2]</p>  <p>91-054 929-04 [3/1] [10/2]</p> <p>-6/01 (-900/..) -6/02 (-900/..) -57/01 (-900/..) -58/01 (-900/..) -69/02 (-900/..)</p> | <p>91-155 753-03 [4] [10/2]</p>  <p>91-054 931-04 [3/1] [10/2]</p> <p>91-054 930-04 [3/1] [10/2]</p> <p>-6/01 (-900/..) -6/02 (-900/..) -69/02 (-900/..)</p> | <p>91-155 871-03 [4] [10/2] [12/2]</p>  <p>91-155 875-04 [3/1] [10/2]</p> <p>-113/03 (-900/..)</p> | <p>91-155 882-03 [4] [10/2] [12/2]</p>  <p>91-155 887-04 [3/1] [10/2]</p> <p>-748/26-113/02 (-900/..)</p> | <p>91-155 902-03 [4] [10/2] [12/2]</p>  <p>91-155 905-04 [3/1] [10/2]</p> <p>-113/02 (-900/..)</p> |

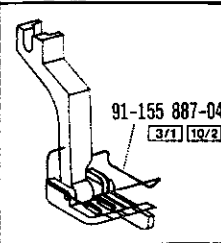
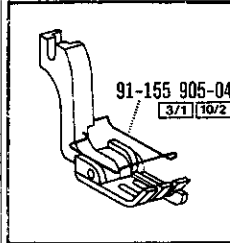
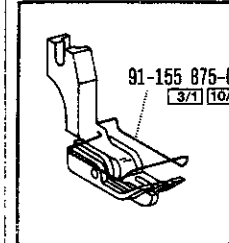
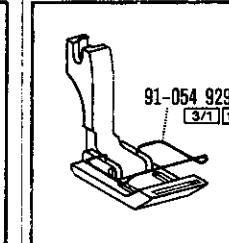
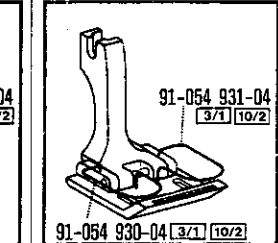
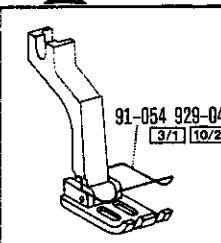
**Nähwerkzeuge
Gauge parts**

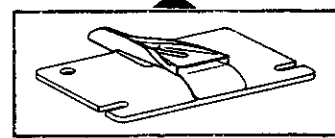
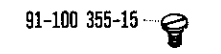
**Organes de couture
Organos de costura**

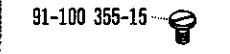
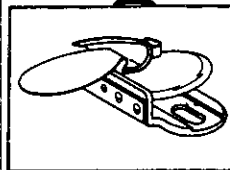
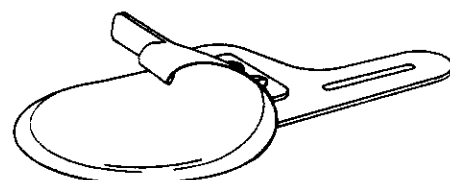
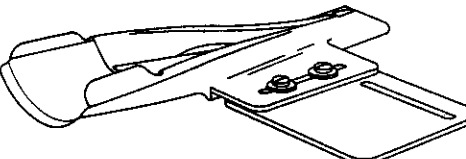
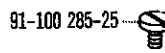
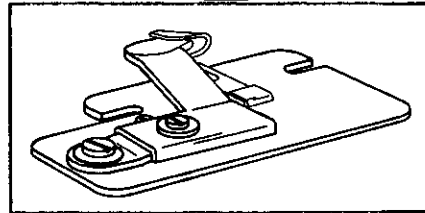
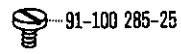
| | | | | |
|--|--|---|---|---|
| <p>91-155 906-03 [4] [10/2] [12/2]</p>  <p>91-155 887-04 [3/1] [10/2]</p> <p>-748/26-113/02 (-900/..)</p> | <p>91-155 911-03 [4] [10/2] [12/2]</p>  <p>91-155 905-04 [3/1] [10/2]</p> <p>-113/02 (-900/..)</p> | <p>91-155 927-03 [4] [10/2] [12/2]</p>  <p>91-155 875-04 [3/1] [10/2]</p> <p>-113/03 (-900/..)</p> | <p>91-157 658-03 [4] [5] [10/2]</p>  <p>91-054 929-04 [3/1] [10/2]</p> <p>-61/01 (-900/..)</p> | <p>91-157 730-03 [4] [5] [10/2]</p>  <p>91-054 931-04 [3/1] [10/2]</p> <p>91-054 930-04 [3/1] [10/2]</p> <p>-61/01 (-900/..)</p> |
| <p>91-460 804-03 [4] [10/2]</p>  <p>91-054 929-04 [3/1] [10/2]</p> <p>-748/26-6/01 (-900/..)</p> | | <p>91-700 335-25</p>  <p>91-026 588-23 [5] [10/2]</p>  <p>-70/01 (-900/..)</p> | | |
| <p>91-100 355-15</p>  <p>91-040 316-93 [5] [10/2]</p>  <p>-58/01 (-900/..)</p> | <p>91-100 355-15</p>  <p>91-040 317-93 [5] [10/2]</p>  <p>-57/01 (-900/..)</p> | <p>91-041 006-23 [5] [10/2]</p>  <p>-19/01 (-900/..)</p> | | |
| <p>91-044 734-23 [5] [10/2]</p>  <p>-70/02 (-900/..)</p> | <p>91-100 285-25</p>  <p>91-050 002-93 [5] [10/2]</p>  <p>91-100 285-25</p>  <p>-83/01 (-900/..) -83/21</p> | | | |

Nähwerkzeuge
Gauge parts

Organes de couture
Organos de costura

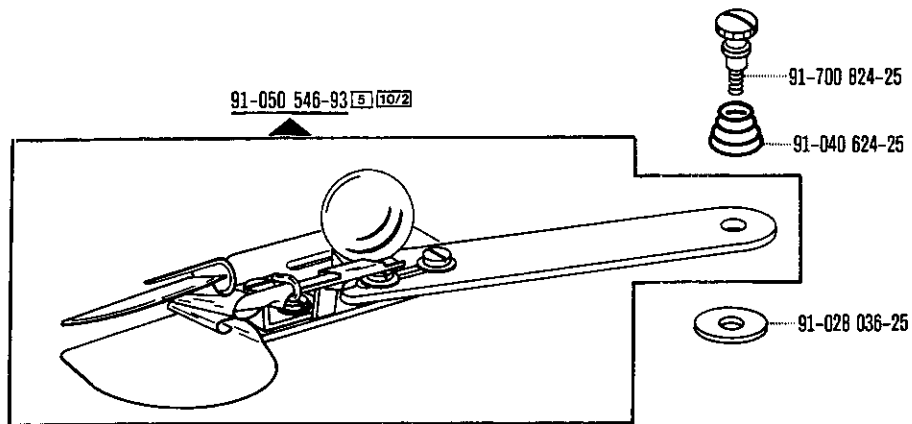

-42/03

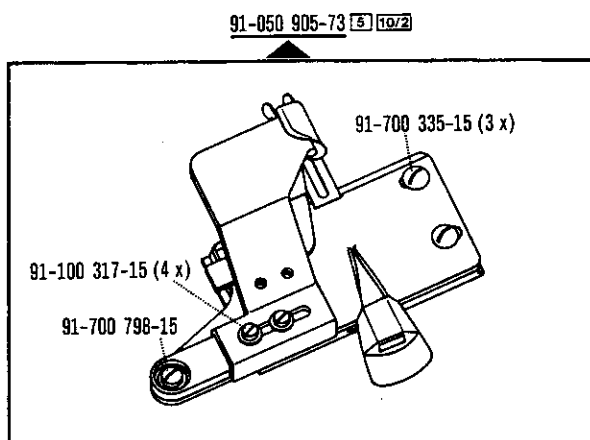

-111/01

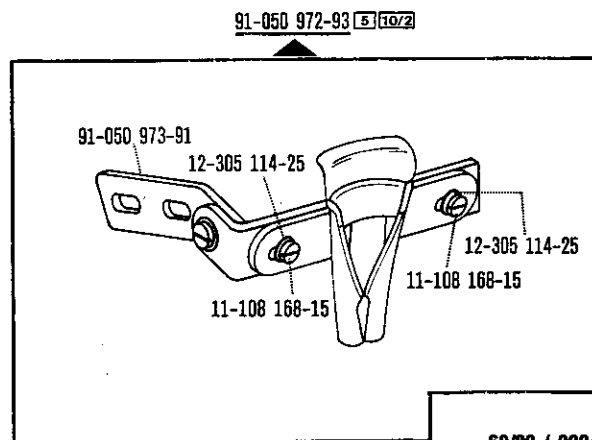

-69/02 (-900/..)
-69/12 (-900/..)
-307/01

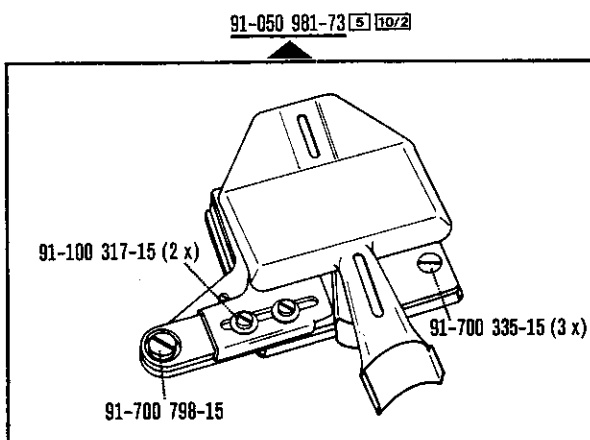

-307/01

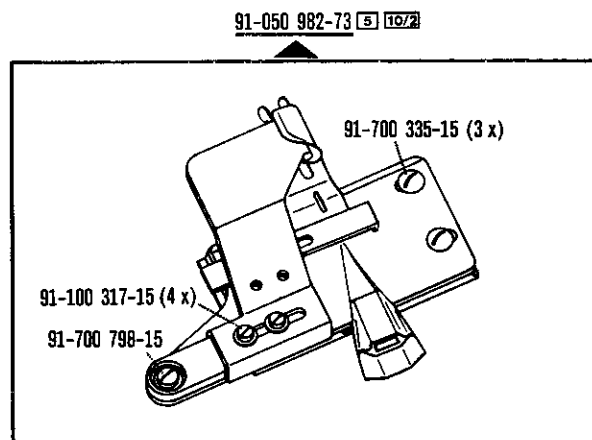

-111/11

**Nähwerkzeuge
Gauge parts**

**Organes de couture
Organos de costura**

91-056 279-73 [5] [10/2]

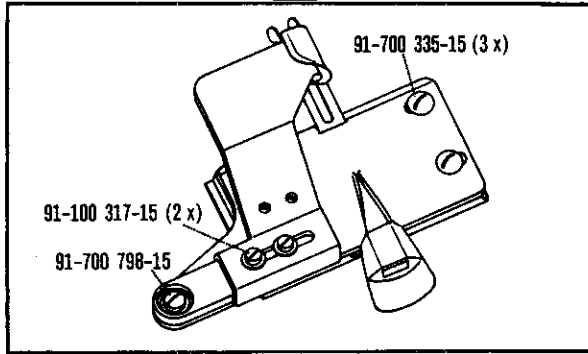

-99/01

91-056 478-93 [5] [10/2]

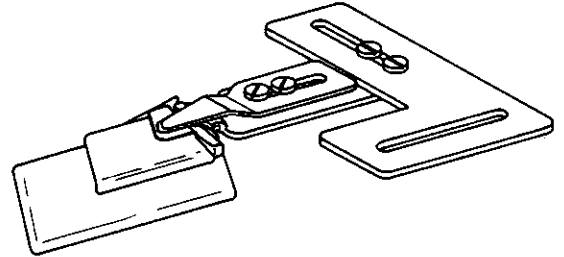

-396/02 (-900/..)

91-056 704-23 [5] [10/2]

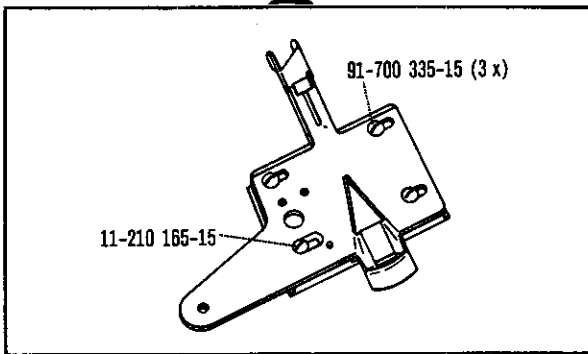

-313/01

91-492 567-23 [5] [10/2]

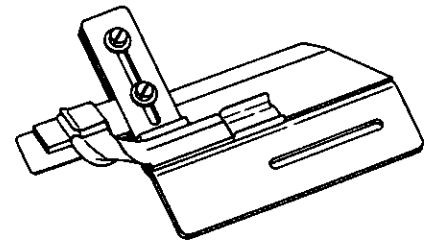

-40/35

91-753 936-90

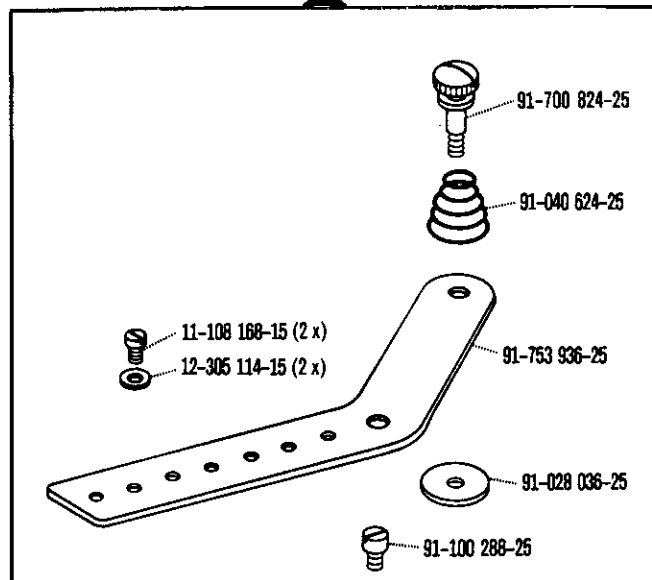

-19/01 (-900/..)
-40/35
-70/02 (-900/..)
-396/02 (-900/..)

Nähwerkzeuge
Gauge parts

Organes de couture
Organos de costura

91-166 296-72/993

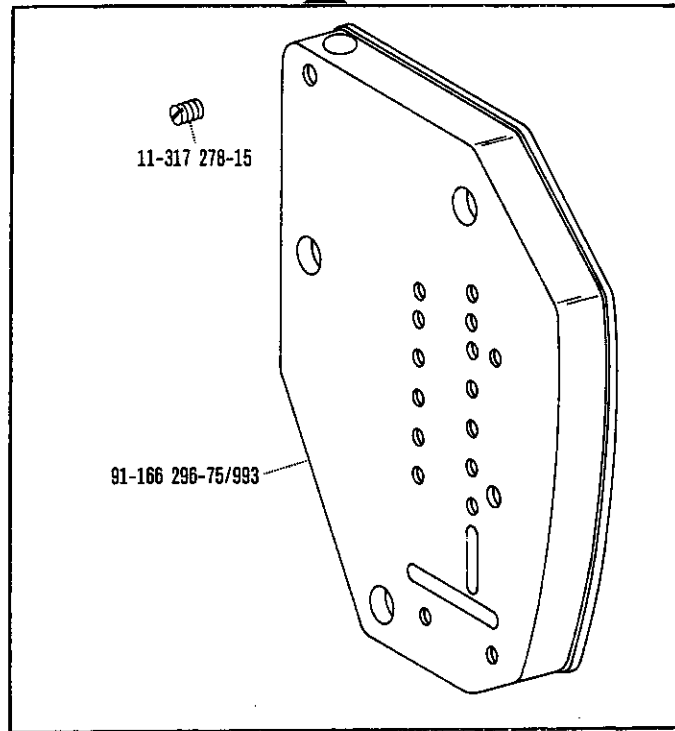

- 61/01 (-900/..)
- 69/01 (-900/..)
- 69/02 (-900/..)
- 69/12 (-900/..)
- 303/11 (-900/..)
- 307/01
- 313/01

91-040 207-70/995

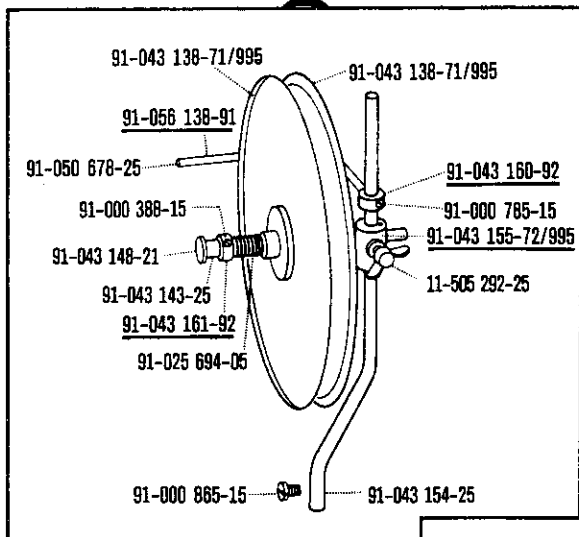

- 61/01 (-900/..)
- 69/01 (-900/..)
- 69/02 (-900/..)
- 69/12 (-900/..)
- 313/01

91-041 644-70/995

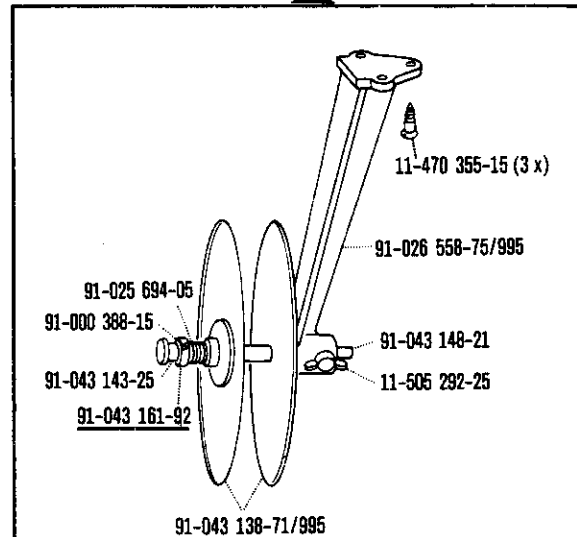

- 63/01
- 70/01 (-900/..)
- 70/02 (-900/..)
- 83/01 (-900/..)
- 83/21
- 99/01
- 313/01

Nähwerkzeuge
Gauge parts

Organes de couture
Organos de costura

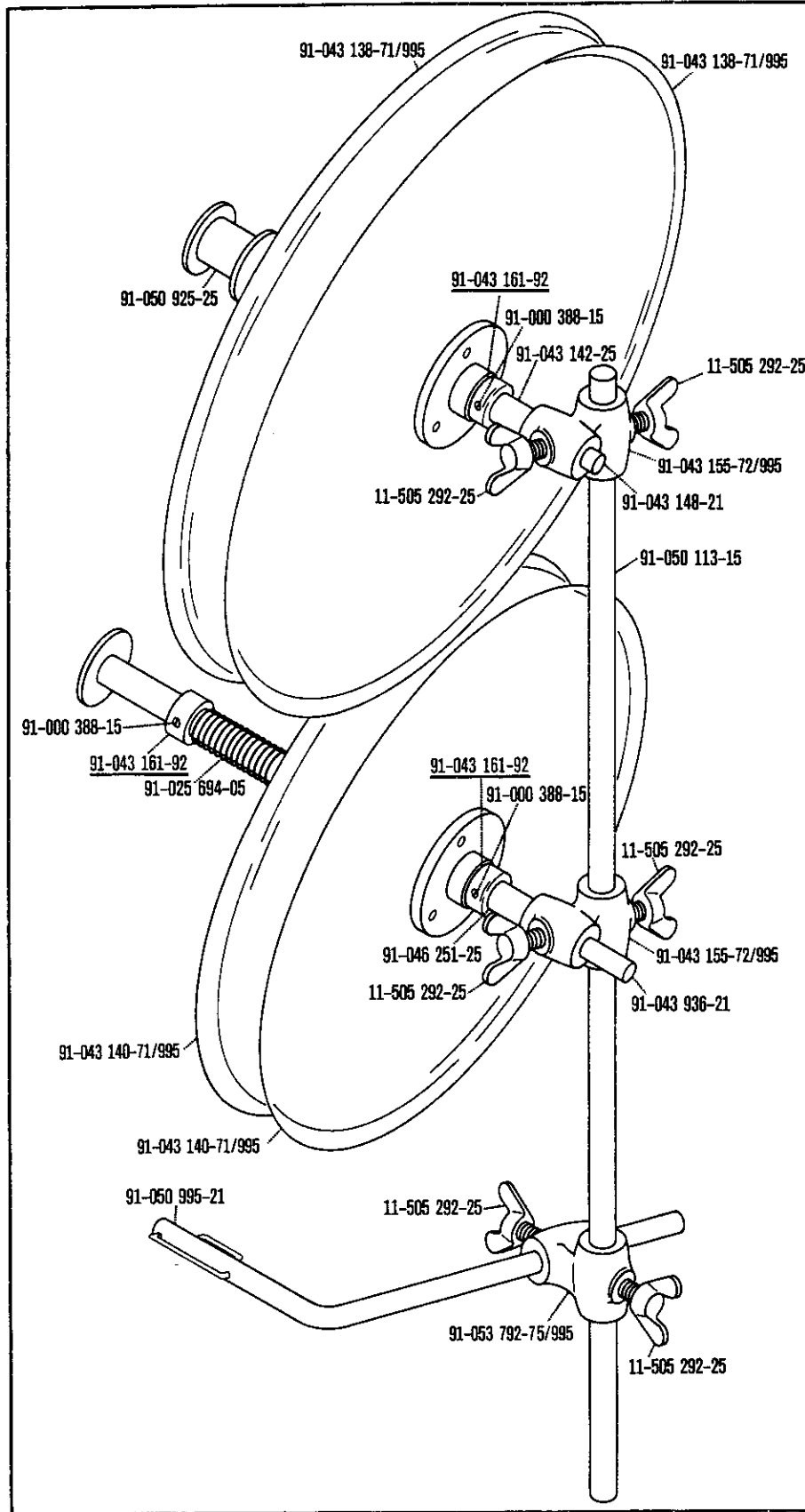

91-056 161-70/995

-307/01

Nähwerkzeuge
Gauge parts

Organes de couture
Organos de costura

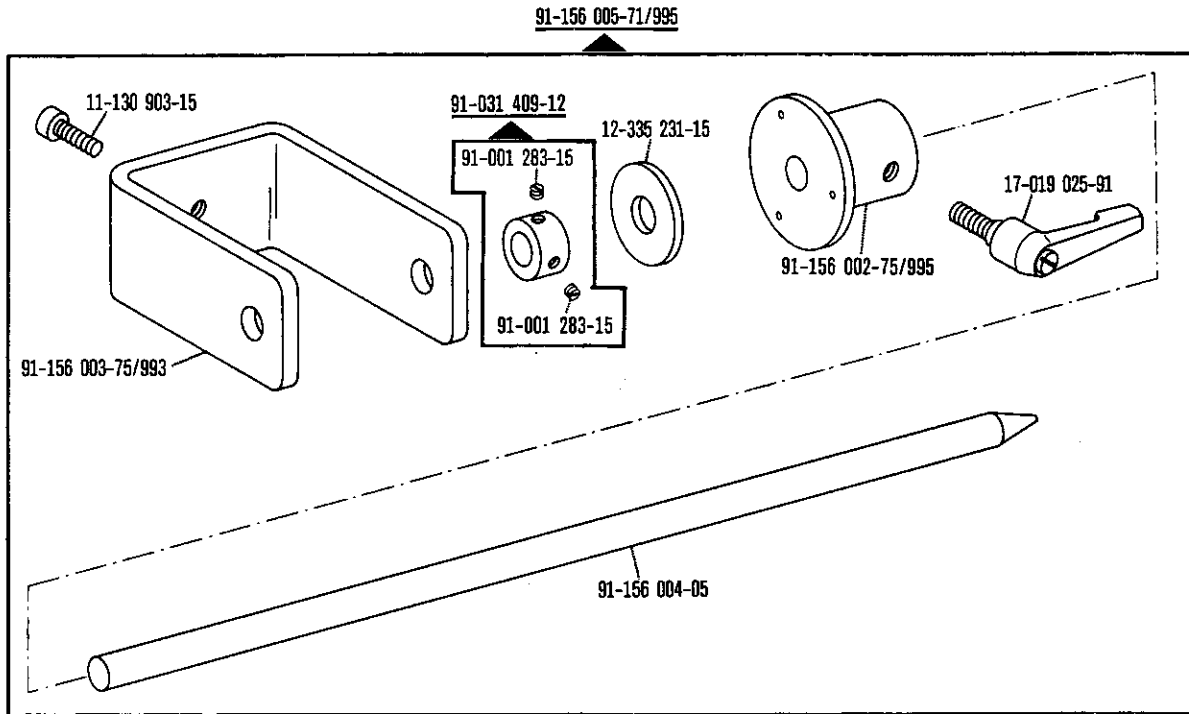

-111/01
-111/11
-307/01

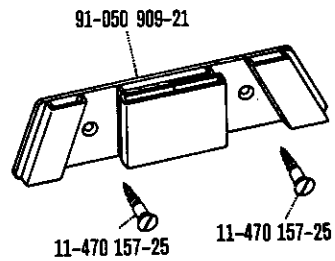
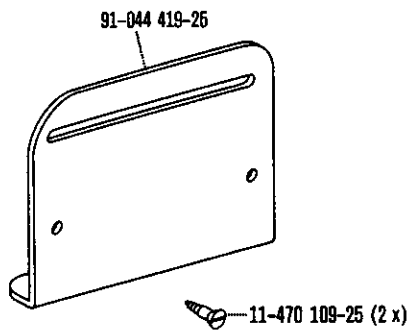

-83/01 (-900/..)
-83/21
-99/01
-111/01
-111/11

-307/01

Nähwerkzeuge
Gauge parts

Organes de couture
Organos de costura

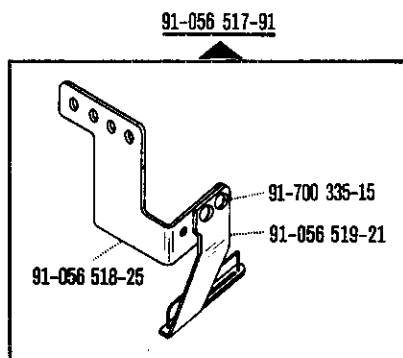

-303/11 (-900/..)

91-056 526-21

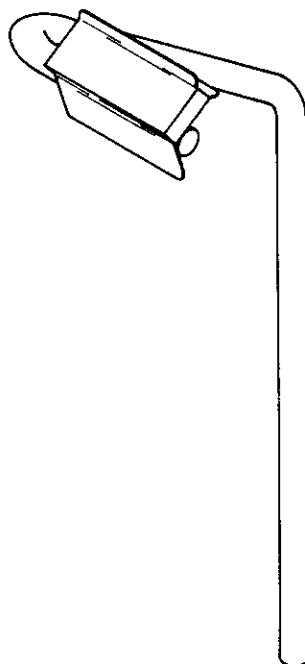

-303/11 (-900/..)

Nähwerkzeuge
Gauge parts

Organes de couture
Organos de costura

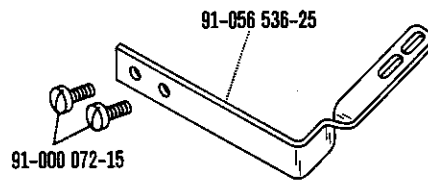

-303/11 (-900/..)

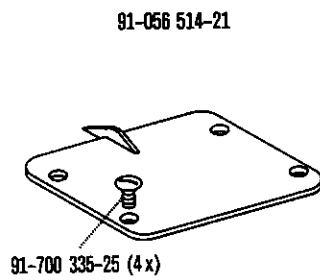

-303/11 (-900/..)

Nähwerkzeuge
Gauge parts

Organes de couture
Organos de costura

91-056 532-71/995

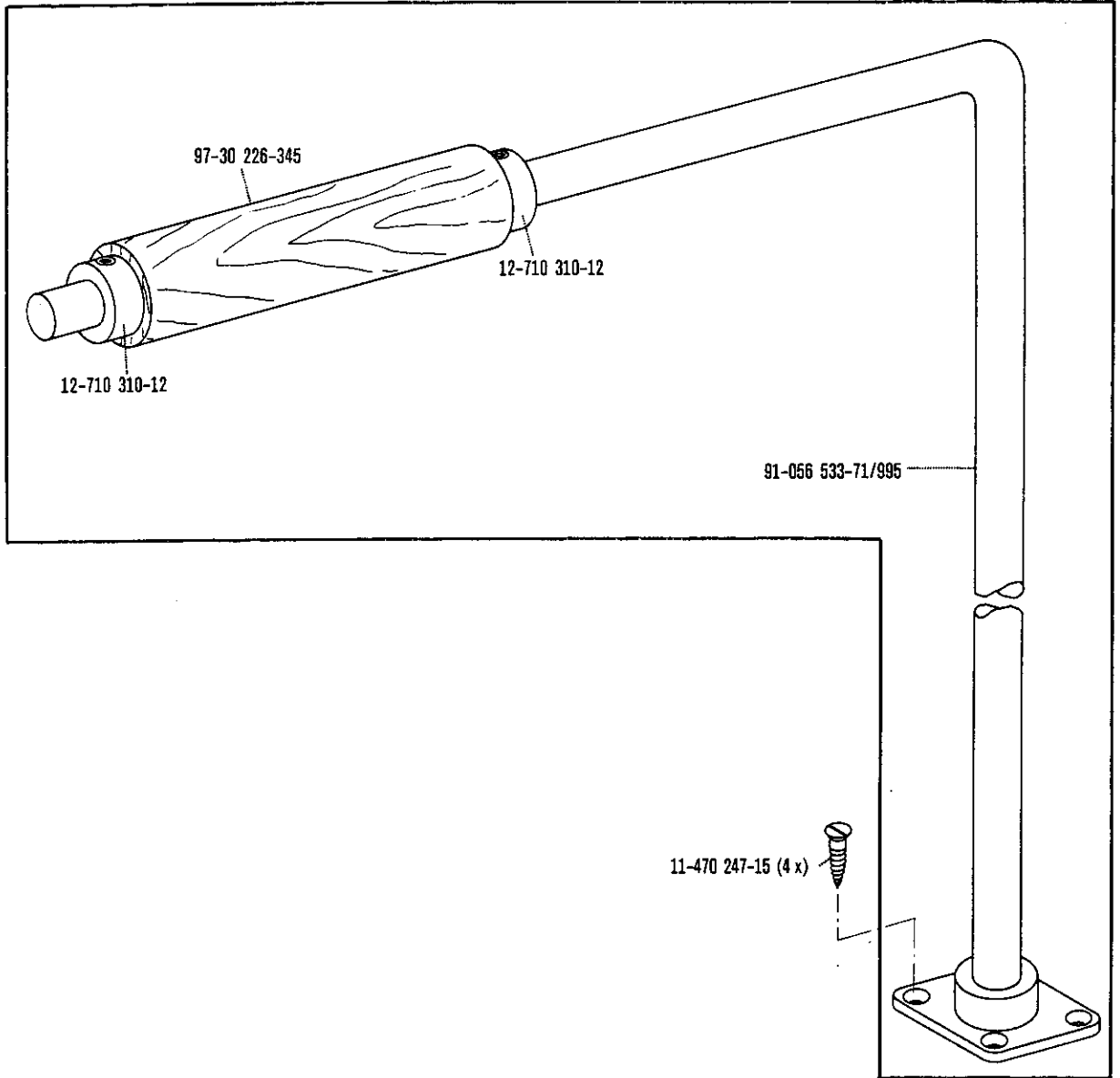

-303/11 (-900/..)