PFAFF[®] **489**

Unterklassen-Ausstattung

Subclass parts

Composition des sous-classes

Composición de las subclases

Equipement des sous-classes

Dotación de las subclases

Unterklasse Subclass Sous-Classe Subclase	Ausführung Model Version Tipo de máquina	Nadelstange Needle bar Barre à aiguille Barra de aguja	Stoffschieberpaar (4) Feed dog pair Paire de griffes Par de transportadores inferiores	Stoffschieber, vorn (5) Feed dog, front Griffe avant Elemento anterior del transportador anterior	Stoffschieber, hinten (5) Feed dog, rear Griffe arrière Elemento posterior del transportador inferior
-6/01*	BN 46	91-171 018-91	91-047 396-03	91-047 551-04	91-047 355-04
	CN 46		91-047 784-00 (28/2)	91-047 785-05 (28/2)	91-047 786-05 (28/2)
-32/21*	BN 46	91-171 018-91	91-047 394-03	91-047 356-04	91-047 357-04
			91-047 781-00 (28/2)	91-047 783-05 (28/2)	91-047 782-05 (28/2)
-34/01*	AN 46	91-171 018-91	91-047 394-03	91-047 356-04	91-047 357-04
	BN 46		91-047 781-00 (28/2)	91-047 783-05 (28/2)	91-047 782-05 (28/2)
-72/03*	AN 46	91-171 018-91	91-047 394-03	91-047 356-04	91-047 357-04
			91-047 781-00 (28/2)	91-047 783-05 (28/2)	91-047 782-05 (28/2)
-230/81*	BN 46	91-171 018-91	91-047 396-03	91-047 551-04	91-047 355-04
			91-047 784-00 (28/2)	91-047 785-05 (28/2)	91-047 786-05 (28/2)
-265/01*	A	91-171 018-91	91-047 394-03	91-047 356-04	91-047 357-04
			91-047 781-00 (28/2)	91-047 783-05 (28/2)	91-047 782-05 (28/2)
-265/02*	A	91-171 018-91	91-047 394-03	91-047 356-04	91-047 357-04
			91-047 781-00 (28/2)	91-047 783-05 (28/2)	91-047 782-05 (28/2)
-748/56-6/01*	BN 46	91-171 018-91	91-047 396-03	91-047 551-04	91-047 355-04
			91-047 784-00 (28/2)	91-047 785-05 (28/2)	91-047 786-05 (28/2)
-748/56-34/01*	AN 46	91-171 018-91	91-047 394-03	91-047 551-04	91-047 355-04
			91-047 784-00 (28/2)	91-047 784-05 (28/2)	91-047 786-05 (28/2)

*) Unterklasse kann mit Faden-durchzieh- und -abschneideinrichtung -900/51; /99 geliefert werden; dabei bleiben die aufgeführten Bestellnummern unverändert.

*) Subclass can be supplied with thread puller / trimmer -900/51; /99 in this case the ordering numbers listed remain unchanged.

*) Sous-classe livrable avec coupe-fil -900/51; /99 les numéros de commande restent inchangés.

*) La subclase se puede suministrar con el cortahilos automático -900/51; /99 permaneciendo invariables los números de pedido indicados.

(4) = Ausführung angeben
= Indicate model
= Préciser la version
= Indíquese el tipo de máquina

(22) = Zubehör
= Accessoires
= Accessoires
= Accesorios

(5) = Nähmuster einsenden
= Submit sewing sample
= Joindre échantillons de couture
= Envíese muestra de costura

(28/2) = Mit Kunststoffbelag
= With plastic coating
= Avec revêtement plastique
= Con recubrimiento de plástico

Equipement des sous-classes

Dotacion de las subclases

Unterklassen-Ausstattung

Subclass organization

Unterklasse Subclase Subclasse Subclase	Ausführung Model Version Tipo de máquina	Stichplatte (4) Needle plate Plaque à aiguille Placa de aguja	Nähfuß (4) Presser foot Pied presseur Pie prensateelas	Apparat (5) Attachment Appareil Aparato	Bandrollenträger Tape reel bracket Plateau derouleur Portarrollos	Bandführung Tape Guide Guide-ruban Guiacintas
-6/01*	BN 46 CN 46	91-058 132-04	91-054 004-03 91-054 012-03 (22)			
-32/21*	BN 46	91-058 130-04	91-051 997-01	91-053 769-24		
-34/01*	AN 46 BN 46	91-058 130-04	91-054 084-03 91-054 051-03 (22)			
-72/03*	AN 46	91-058 130-04	91-051 997-01	91-050 838-91	91-056 553-92	91-053 953-21
-230/81*	BN 46	91-058 132-04	99-117 802-91 99-117 803-91			
-265/01*	A	91-058 130-04	91-051 922-23 (5)	91-053 368-21		
-265/02*	A	91-058 130-04	91-051 922-23 (5)	91-053 575-21	91-041 644-91	
-748/56-6/01*	BN 46	91-058 132-04	91-155 125-03			
-748/56-34/01*	AN 46	91-058 130-04	91-157 866-03			

Unterklassen-Übersicht/Table of subclasses/Table des sous-classes/Tabla de subclases

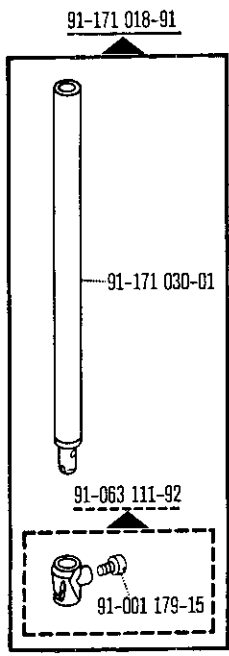

- 6/01
- 32/21
- 34/01
- 72/03
- 230/81
- 265/01
- 265/02
- 748/56-6/01
- 748/56-34/01

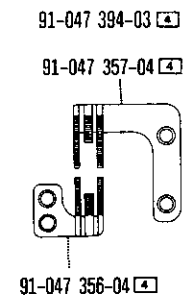

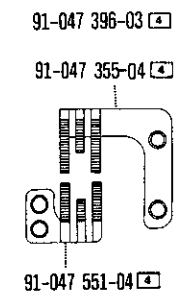

- 32/21
- 34/01
- 72/03
- 265/0
- 265/0
- 748/5

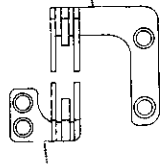
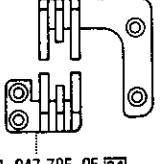
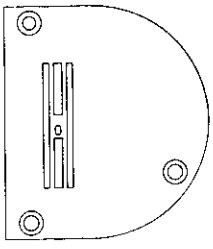
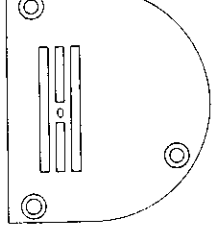
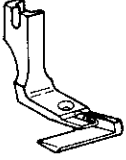

- 6/01
- 230/
- 748/

Unterklassen-Ubersicht/ Table of subclasses/ Table des sous-classes/ Tabla de subclases

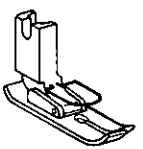
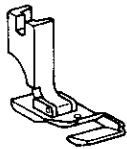
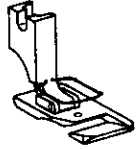
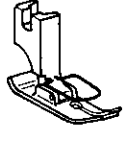
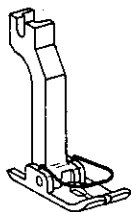
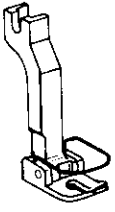
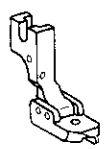
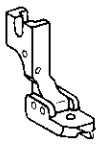
<p>91-047 781-00 </p> <p>91-047 782-05 </p>  <p>91-047 783-05 </p> <p>-32/21 -34/01 -72/03 -265/01 -265/02</p>	<p>91-047 784-00 </p> <p>91-047 786-05 </p>  <p>91-047 785-05 </p> <p>-6/01 -230/81 -748/56-6/01 -748/56-34/01</p>		
<p>91-058 130-04 </p>  <p>-32/21 -34/01 -72/03 -265/01 -265/02 -748/56-34/01</p>	<p>91-058 132-04 </p>  <p>-6/01 -230/81 -748/56-6/01</p>		
		<p>91-051 922-23 </p>  <p>-265/01 -265/02</p>	<p>91-051 997-01</p>  <p>-32/21 -72/03</p>
<p>91-054 004-03 </p>  <p>-6/01</p>	<p>91-054 012-03 </p>  <p>-6/01</p>	<p>91-054 051-03 </p>  <p>-34/01</p>	<p>91-054 084-03 </p>  <p>-34/01</p>
<p>91-155 125-03 </p>  <p>-748/56-6/01</p>	<p>91-157 866-03 </p>  <p>-748/56-34/01</p>	<p>99-117 802-91</p>  <p>-230/81</p>	<p>99-117 803-91</p>  <p>-230/81</p>

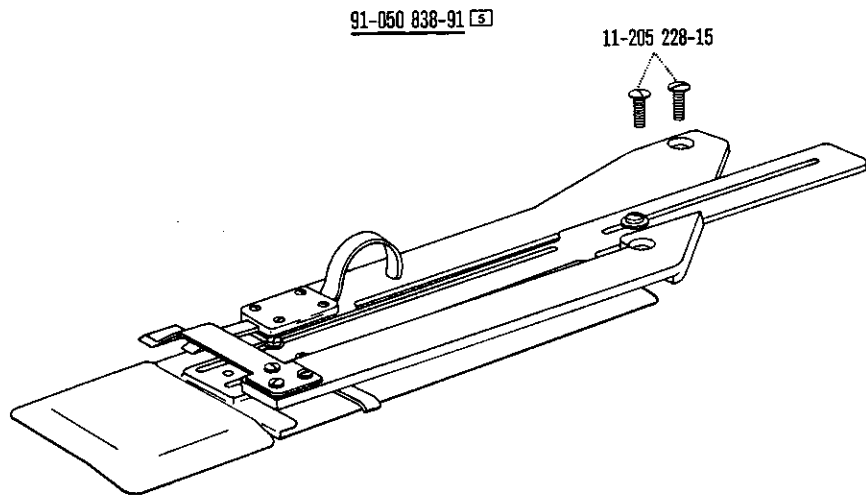

-72/0

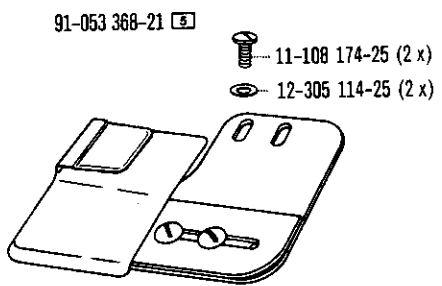

-265/01

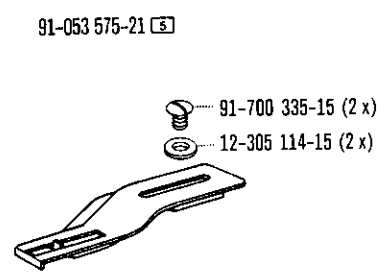

-265/0

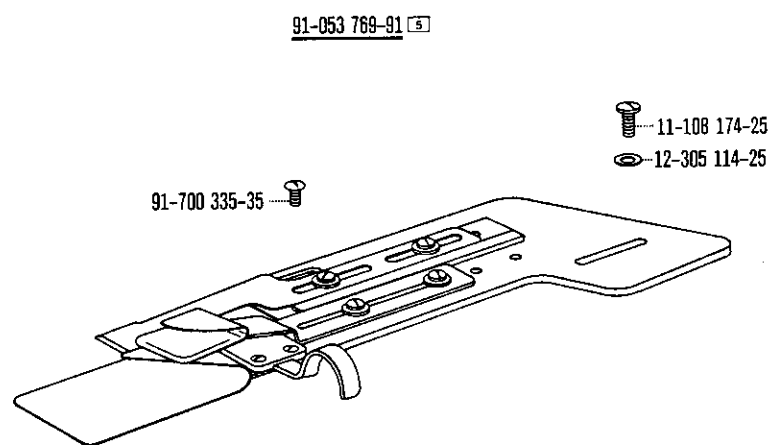

-32/1

91-041 644-91

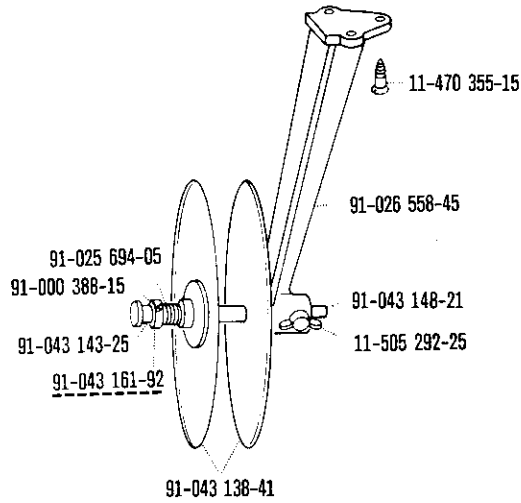

-265/02

91-056 553-92

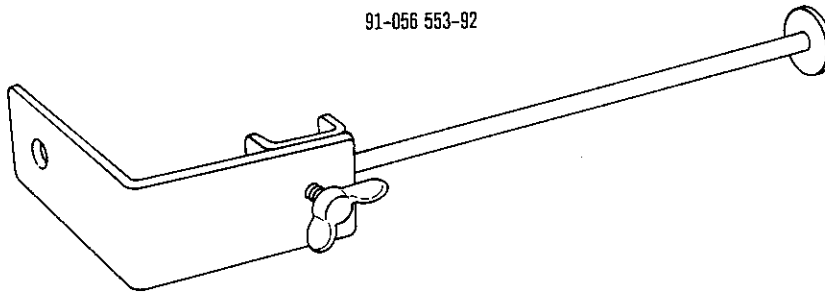

-72/03

91-053 953-21

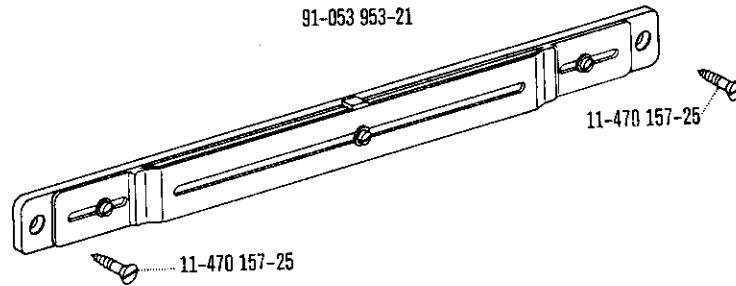

-72/03

Pfaff, D 6750 Kaiserslautern, Postfach 3020/3040, Telefon (0631) 200-0, Telex: 45753, Telefax (0631) 17202