

PFAFF

MAUSER SPEZIAL

9020

Parts list

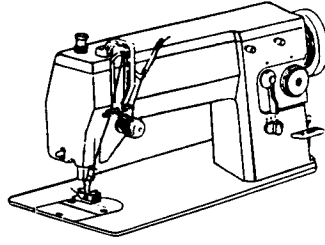

GS139-8



GS147-8

GR489/3-8

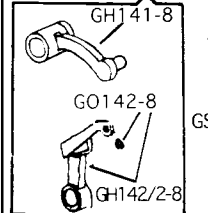

GS166

GR48

GH1

GR487/5-8

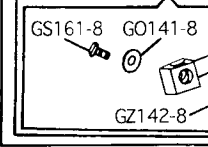

GS1

G

GR49

G

G

G

G

G

G

GS375-8(2)

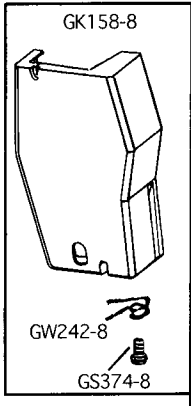

GS384-8

GL178-8

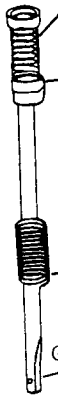

GW153-8

GZ187-8

GR231-8



GS223-8

GR523/2-8

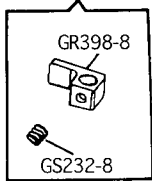

GX180-8

GR486/6-8

GZ223-8

GR485/5-8

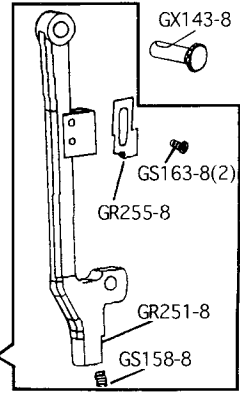

GR484/4-8

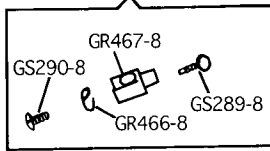

GR733-8



GS232-8



GX183-8

GS231-8



GR465/4-8

GR373-8

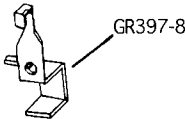

GR397-8



GW135-8

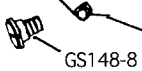

GS148-8

GR476/4-8

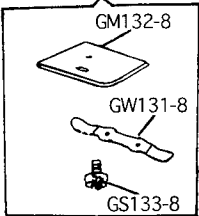

GM132-8

GW131-8

GS133-8

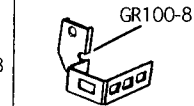

GR100-8

GR477/4-8

GS134-8(2)



GM156-8

GM130-8

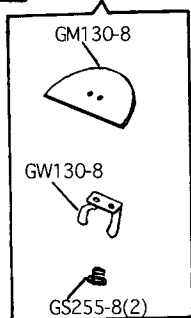

GW130-8

GS255-8(2)

GS288-8

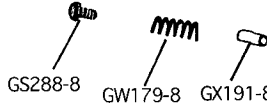

GW179-8

GX191-8

GT150-8



GS264-8

GR496/2-8

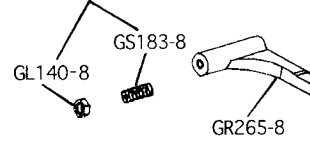

GL140-8

GS183-8

GR265-8

GS147-8

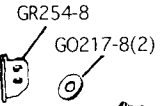

GR254-8

G0217-8(2)

GS132-8(2)

GR729/11-8

GR496/2-8

GS183-8

GR265-8

G0164-8

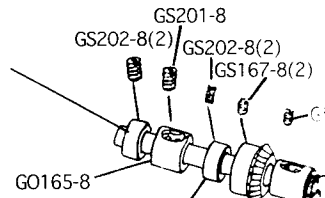

GS201-8

GS202-8(2)

GS202-8(2)

GS167-8(2)

G0165-8

G0164-8

GS132-8



GN130-8



GN131-8

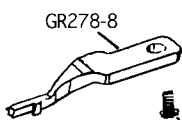

GR278-8

GN135-8

GS256-8

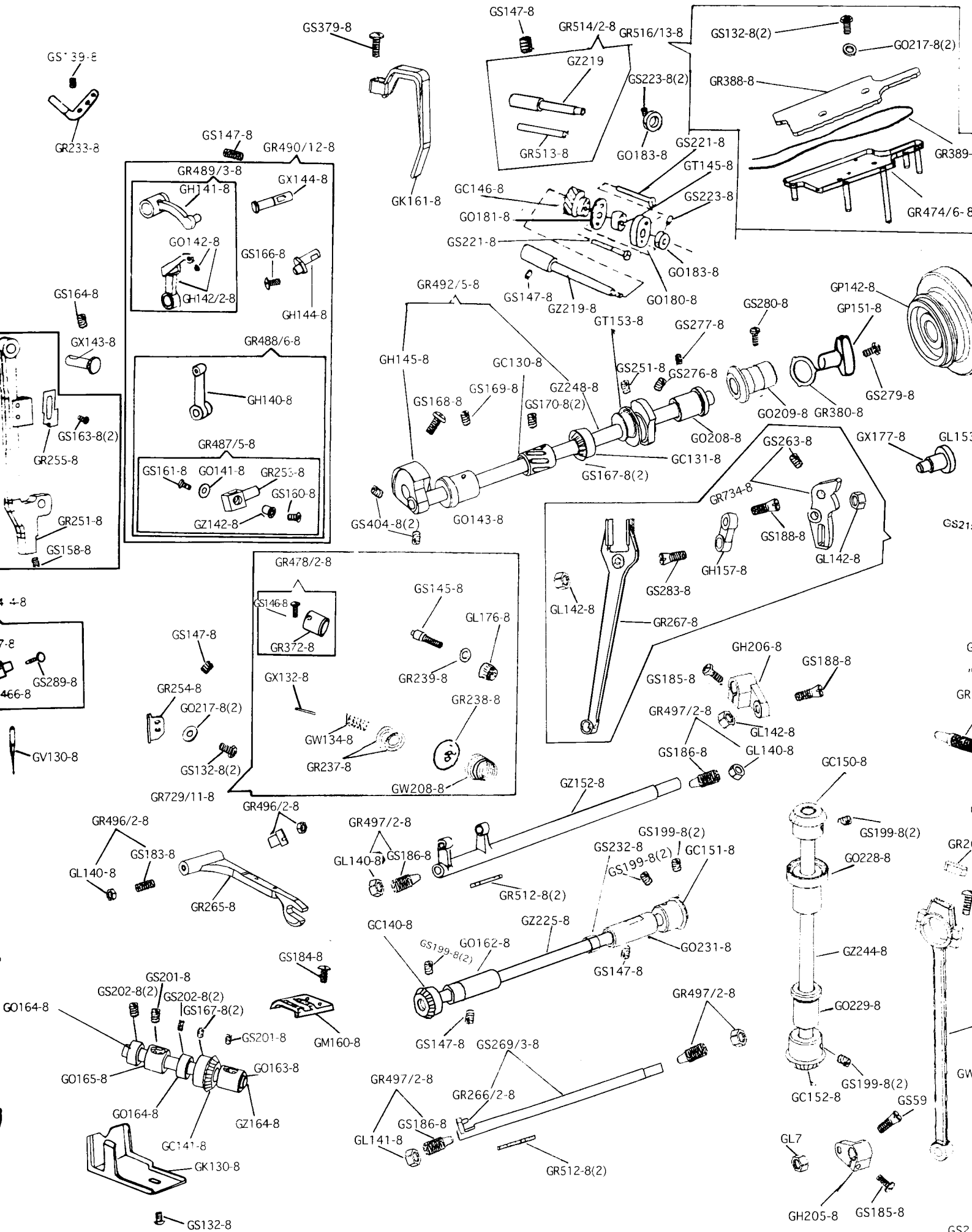

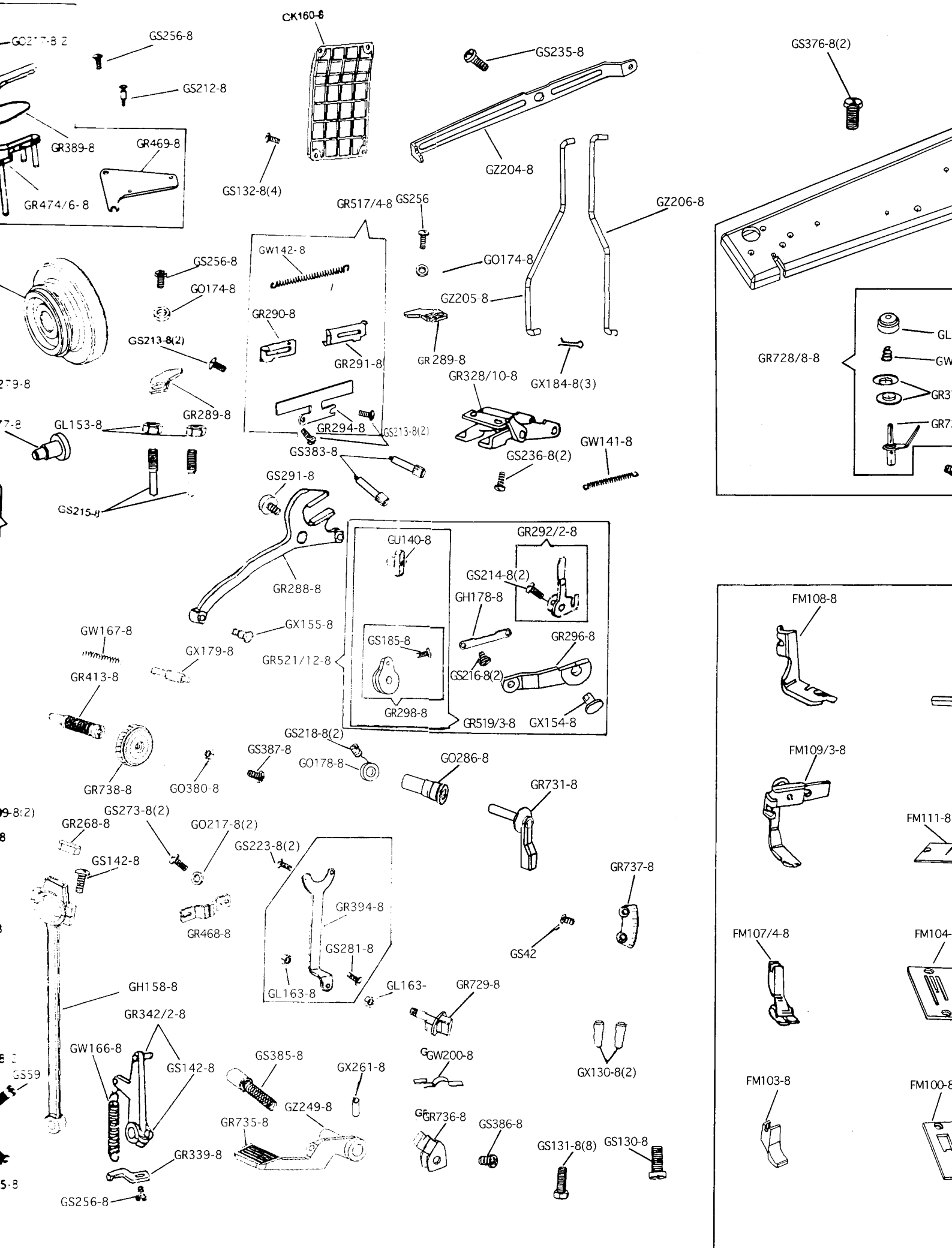

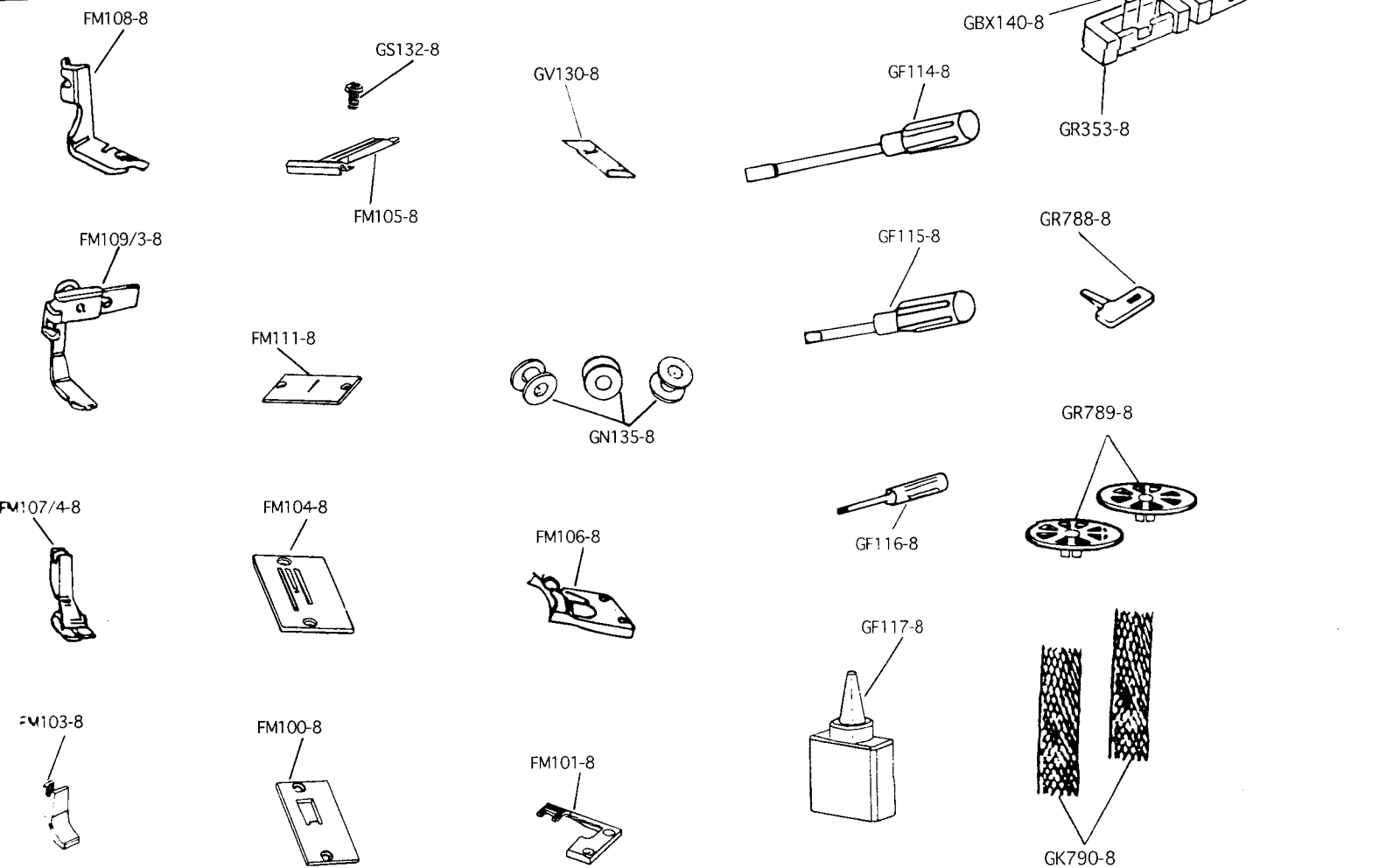
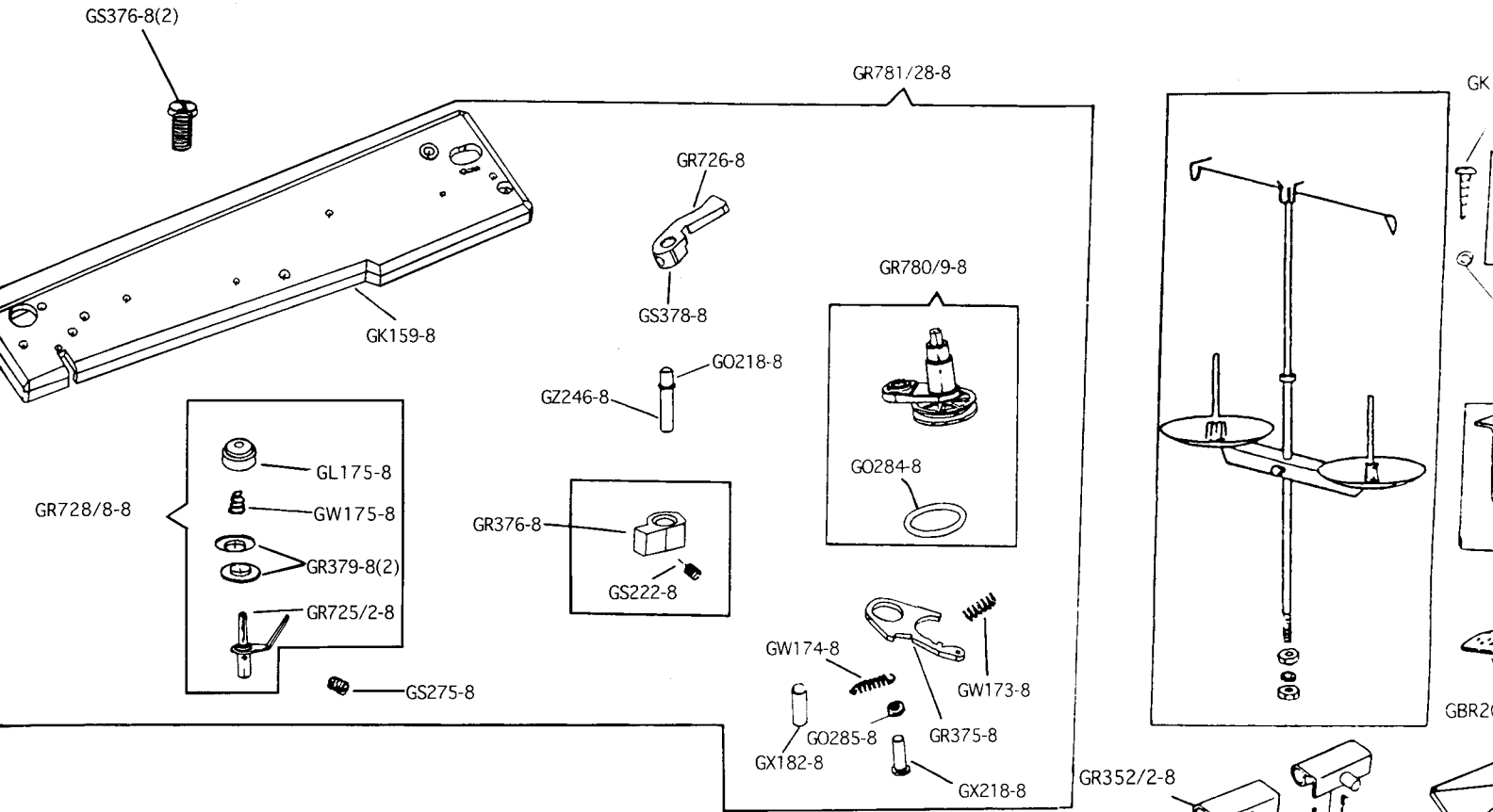

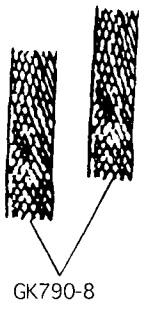
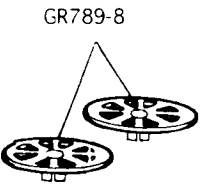
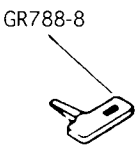
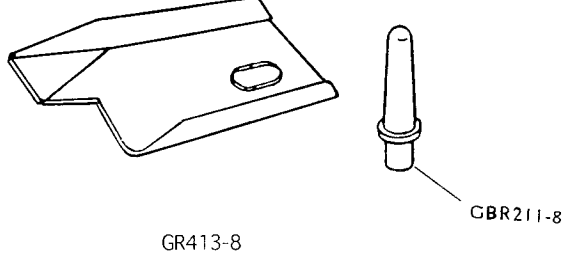
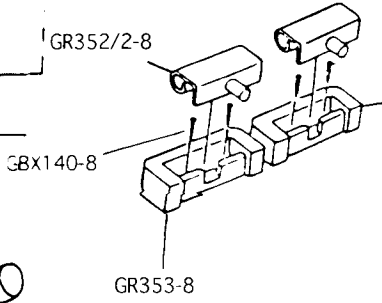
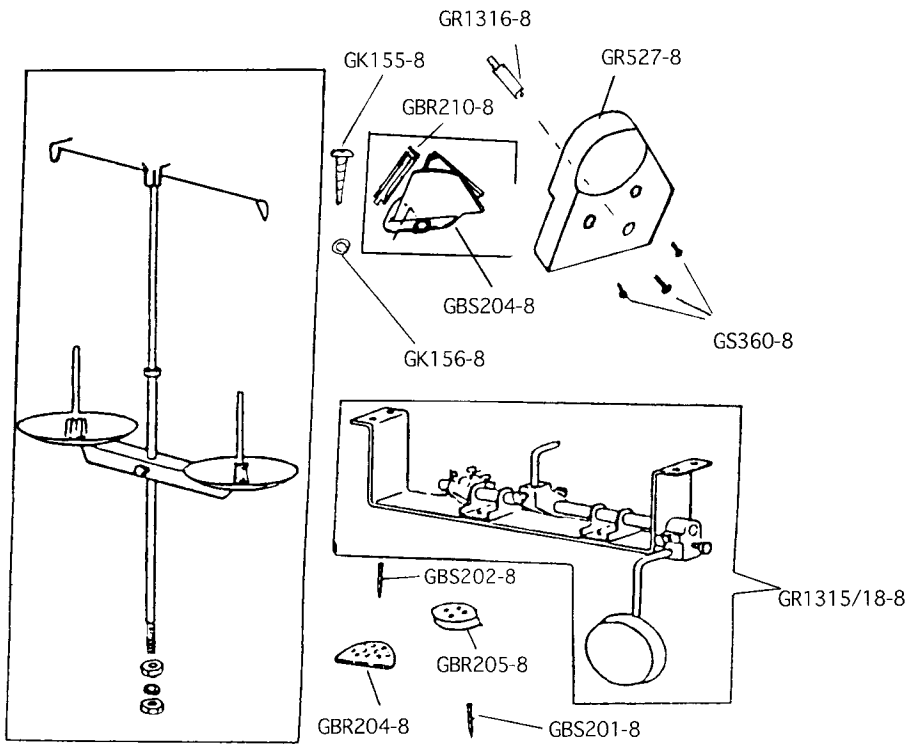

NUMERICAL LIST OF PARTS

Part NO.	Description	Part NO.	Description
GK158-8	Face plate	GR780/9-8	Thread winding shaft assembly
GR242-8	Face plate thread guard	GO284-8	Rubber ring
GS374-8	Face plate thread guard screw	GR375-8	Thread winding swaying handle
GS375-8	Face plate screw (2)	GX218-8	Thread winding crank pin
GK161-8	Thread take-up guard	GS275-8	Thread winding crank pin screw
GS379-8	Thread take-up guard screw	GW173-8	Thread winding swaying handle pressing spring
GK160-8	Back cover	GW174-8	Thread winding swaying handle extension spring
GS132-8	Back cover screw (4)	GX182-8	Extension spring pin
GR233-8	Thread retainer	GR376-8	Thread winding locating block
GS139-8	Thread retainer screw	GS222-8	Thread winding locating block set screw
GR231-8	Thread guard	GO285-8	Thread winding swaying handle cushion
GS223-8	Thread guard screw	GR726-8	Volume-adjusting plate
GX180-8	Thread sliding shell	GS378-8	Volume-adjusting plate screw
GT150-8	Linear lock eccentric cover	GZ246-8	Thread winding shaft
GS264-8	Linear lock eccentric cover screw	GO218-8	Thread winding shaft stop ring
GK130-8	Rotating hook guard plate	GS164-8	Pin screw of needle bar vibrating lever
GS132-8	Rotating hook guard plate screw	GR251-8	Needle bar vibrating lever
GM156-8	Throat plate	GS158-8	Eccentric pin screw of needle bar
GS338-8	Throat plate screw (2)	GR255-8	Needle bar position plate
GR476/4-8	Slide plate assembly	GS163-8	Needle bar position plate screw (2)
GM132-8	Slide plate	GX143-8	Pin of needle bar vibrating lever
GW131-8	Slide plate spring	GZ223-8	Needle bar
GS133-8	Slide plate spring screw (2)	GR467-8	Needle clamp
GR477/4-8	Bed plate assembly	GS290-8	Screw of thread guard
GM130-8	Bed plate	GR466-8	Needle bar thread guard
GW130-8	Bed plate spring	GS289-8	Needle set screw
GS255-8	Bed plate spring screw (2)	GS161-8	Pin screw of needle bar clamp
GR373-8	Thread tension releasing lever	GO241-8	Pin washer of needle bar clamp
GW135-8	Thread tension releasing lever spring	GR253-8	Needle bar clamp
GS148-8	Thread tension releasing lever screw	GZ142-8	Pin of needle bar clamp
GR729/11-8	Thread tension assembly	GS160-8	Pin set screw of needle bar clamp
GL176-8	Thread tension nut	GR254-8	Needle bar connecting link guide
GR239-8	Thread holding brake	GO217-8	Needle bar connecting link guide washer(2)
GW208-8	Thread tension spring	GS132-8	Needle bar connecting link guide screw
GR238-8	Thread tension releasing disc	GS166-8	Left-hand thread screw
GR237-8	Thread tension disc(2)	GH140-8	Needle bar connecting link
GS145-8	Thread tension post	GH144-8	Needle bar crank
GW134-8	Thread take-up spring	GH142/2-8	Thread take-up lever assembly
GR372-8	Thread take-up spring adjusting base	GO142-8	Thread guide ring
GS146-8	Thread tension post set screw	GH141-8	Thread take-up rocker
GS147-8	Thread tension assembly set screw	GX144-8	Thread take-up rocker pin
GX132-8	Thread tension releasing pin	GS147-8	Thread take-up rocker pin screw
GX191-8	Eccentric cover supporting pole	GS168-8	Thread take-up crank screw
GW179-8	Eccentric cover pressing spring	GH145-8	Thread take-up crank
GS288-8	Pressing spring screw	GS404-8	Needle bar crank set screw (2)
GK159-8	Upper cover	GO143-8	Upper shaft
GS376-8	Upper cover screw	GS277-8	Upper shaft set screw
GR728/8-8	Upper thread tension retainer	GC130-8	Upper shaft spiral gear
GR725/2-8	Upper thread retaining plate	GS170-8	Upper shaft spiral gear screw (2)
GR379-8	Upper thread tension disc(2)	GC131-8	Upper shaft bevel gear
GW175-8	Upper thread tension spring	GS167-8	Upper shaft bevel gear screw (2)
GL175-8	Upper thread tension nut	GT153-8	Feed cam
GS275-8	Upper thread tension post set screw	GS251-8	Feed cam set screw

NUMERICAL LIST OF PARTS

Part NO.	Description	Part NO.	Description
GS276-8	Feed cam position screw	FM111-8	Emboidery plate
GO208-8	Upper shaft back bushing	FM107/4-8	Straight stitch foot
GZ248-8	Upper shaft	FM104-8	Straight stitch throat plate
GO209-8	Hand wheel shaft bushing	FM103-8	Straight stitch feed dog
GS280-8	hand wheel shaft bushing screw	GV130-8	Needle
GP142-8	Hand wheel	GN135-8	Bobbin
GR380-8	Clutch wash	GF114-8	Screwdriver (L)
GP151-8	Clutch hand wheel	GF115-8	Screwdriver (M)
GS279-8	Small clutch screw	GF116-8	Screwdriver (S)
GV130-8	Needle	GF117-8	Oiler
GS277-8	Upper shaft back bushing	GR788-8	T-type open knife
GS200-8	Hand wheel set screw (2)	GR790-8	Anti-spill sleeve
GS142-8	Feed bar lifting link screw	GR789-8	Spool cap
GR268-8	Oil felt	GMI72-8	Buttonhole foot
GH158-8	Feed bar lifting link	GS256-8	Rotating hook position plate screw
GS59-8	Small cone nut	GR278-8	Rotating hook position plate
GH157-8	Stich regulator block connecting link	GN131-8	Bobbin case
GL142-8	Small cone nut	GN135-8	Bobbin
GL141-8	Feed rock shaft centre nut	GN130-8	Rotating hook
GS186-8	Feed rock shaft centre screw	GO163-8	Front bushing of rotating hook shaft
GH206-8	Feed rock shaft crank	GS201-8	Front bushing screw of rotating hook shaft
GS185-8	Feed crank screw	GO164-8	Retainer of rotating hook shaft(2)
GS184-8	Feed dog screw	GS202-8	Retainer screw of rotating hook shaft(4)
GMI60-8	Feed dog	GO165-8	Back bushing of rotating hook shaft
GL140-8	Feed bar centre nut	GS201-8	Back bushing screw of rotating hook shaft
GS183-8	Feed bar centre screw	GZ164-8	Rotating hook shaft
GZ152-8	Feed rock shaft	GS167-8	Rotating hook shaft bevel gear screw (2)
GR265-8	Feed bar	GC141-8	Rotating hook shaft bevel gear
GR269/3-8	Feed bar lifting crank assembly	GC140-8	Lower shaft bevel gear
GS185-8	Feed bar lifting crank screw	GS199-8	Lower shaft bevel gear screw (2)
GH205-8	Feed bar lifting crank	GO162-8	Front bushing of lower shaft
GR512-8(2)	Oil braid	GS147-8	Front bushing screw of lower shaft
GR267-8	Feed fork	GZ225-8	Lower shaft
GS283-8	Feed fork centre screw	GO232-8	Retainer of lower shaft
	Thread unwinder complete	GS199-8	Retainer screw of lower shaft(2)
GR1315/18-8	Knee lifter complete	GO231-8	Back bushing of lower shaft
GR527-8	Hand wheel cover	GS147-8	Back bushing screw of lower shaft
GBS204-8	Back cover of hand wheel	GC151-8	Lower shaft bevel gear
GS293-8	Back cover of hand wheel screw	GS199-8	Lower shaft bevel gear screw (2)
GS360-8	Hand wheel cover screw	GS199-8	Bevel gear screw of vertical shaft(2)
GBR204-8	Machine head cushion	GC152-8	Vertical shaft Bevel gear
GBR205-8	Machine head cushion	GO229-8	Lower bushing of vertical shaft
GBS202-8	Machine head cushion nail	GZ224-8	Vrtical shaft
GBS201-8	Oil reservoir nail	GO228-8	Upper bushing of vertical shaft
GR413-8	Oil reservoir	GS199-8	Bevel gear screw of vertical shaft(2)
GBR203-8	Machine head pole	GC150-8	Vertical shaft Bevel gear
GR353-8	Machine head hinge cushion rubber	GR288-8	Zigzag stitch regulator fork
GBX140-8	Machine head hinge cushion rubber nail	GZ219-8	Zigzag triangular cam shaft
GR352/2-8	Machine head hinge complete	GS147-8	Screw of zigzag triangular cam shaft
FM108-8	Hemmer foot	GC146-8	Zigzag triangular camgear
GS132-8	Hwm edge guide screw	GO181-8	Eccentric stop ring
FM105-8	Hem edge guide	GS221-8	Zigzag eccentric cam connecting screw(2)
FM109/3-8	Zipper foot complete	GT145-8	Zigzag eccentric cam

NUMERICAL LIST OF PARTS

Part NO.	Description	Description
GO180-8	Back stop ring of Zigzag eccentric cam	GW153-8 Presser bar spring
GS223-8	Stop ring screw of Zigzag triangular cam shaft (2)	GZ187-8 Presser bar
GO183-8	Stop ring of Zigzag triangular cam shaft	GS231-8 Presser foot screw
GW142-8	Bight amplitude regulating plate spring	GR465/4-8 Presser foot complete
GR469-8	Oil pan plate	GR733-8 Presser foot lifter
GX155-8	Zigzag stitch regulator fork eccentric	GS232-8 Presser foot lifter pin screw
GU140-8	Bight amplitude slide block	GX183-8 Presser foot lifter pin
GR298-8	Bight amplitude slide block guide	GS232-8 Presser bar guide bracket set screw
GS185-8	Bight amplitude slide block guide stud set screw	GR398-8 Presser bar guide bracket
GH178-8	Bight amplitude slide block crank link	GR397-8 Presser bar lifting and releasing lever bracket
GS216-8	Bight amplitude slide block crank link hinge(2)	GR328/10-8 Bell crank complete
GR296-8	Bight and L-C-R position lever arm	GS236-8 Knee lifter lever bracket screw
GX154-8	Bight amplitude slide block guide stud	GX184-8 Open pin
GS215-8	Bight and L-C-R position lever arm regulating screw(2)	GZ205-8 Lifting lever connecting rod
GL153-8	Bight and L-C-R position lever arm regulating nut(2)	GZ206-8 Bight amplitude slide block crank knee operating connection
GS214-8	Bight amplitude slide block crank set screw(2)	GS235-8 Lifting lever hinge screw
GW141-8	Bight amplitude slide block crank return spring	GZ204-8 Lifting lever
GR292/2-8	Bight amplitude slide block crank complete	GR1000-8 Needle guard
GS218-8	Bight amplitude slide block crank shaft bushing collar set screw(2)	GS413-8 Feed regulating stud
GO178-8	Bight amplitude slide block crank shaft bushing collar	GX177-8 Feed regulator hinge stud
GS291-8	Bight amplitude slide block cap screw	GS263-8 Feed regulator hinge stud set screw
GO286-8	Bight amplitude slide block crank shaft bushing	GR734-8 Feed regulator
GR731-8	Bight amplitude slide block crank shaft knob	GW166-8 Feed reverse lever return spring
GR468-8	Bight and L-C-R position block	GS256-8 Feed reverse lever return spring bracket screw
GS273-8	Bight and L-C-R position block set screw(2)	GR339-8 Feed reverse lever return spring bracket
GR729-8	Bight and L-C-R position lever complete	GR342/2-8 Feed reverse lever crank complete
GS281-8	Bight and L-C-R position lever screw pin	GS142-8 Feed reverse lever crank screw
GR394-8	Bight and L-C-R position lever	GZ249-8 Feed reverse lever hinge stud
GS223-8	Bight and L-C-R position lever set screw (2)	GR735-8 Feed reverse lever
GL163-8	Bight and L-C-R position lever screw pin nut (2)	GS385-8 Feed reverse adjusting screw
GR289-8	Bight amplitude stop plate (left)	GS387-8 Feed regulating dial stud
GR289-8	Bight amplitude stop plate (right)	Feed regulating dial stud washer
GO174-8	Bight amplitude stop plate washer(2)	GR738-8 Feed regulating dial
GS256-8	Bight amplitude stop plate screw (2)	GX179-8 Feed regulating stud lock pin
GS383-8	Bight amplitude regulating plate thumb screw(2)	GW167-8 Feed regulating stud lock pin spring
GS213-8	Bight amplitude regulating plate holder set screw(2)	GS42 Feed reverse regulating indicating-dial screw(2)
GR294-8	Bight amplitude regulating plate holder	GR737-8 Feed reverse regulating indicating-dial
GR290-8	Bight amplitude regulating plate (A)	GW200-8 Feed reverse regulating screw clamping spring
GR291-8	Bight amplitude regulating plate (B)	GR736-8 Feed reverse regulating plate
GS212-8	Oil reservoir plate set screw(front)	GS386-8 Feed reverse regulating plate screw
GS256-8	Oil reservoir plate set screw (back)	GX261-8 Feed reverse lever hinge stud
GR474/6-8	Oil reservoir complete	GR789-8 Thread Unwinder spool cap (2)
GR389-8	Oil wick	GR790-8 Thread Unwinder spool Net (2)
GR388-8	Oil reservoir felt	GR788-8 Screw Driver (for throat plate)
GO217-8	Oil reservoir set screw washer (2)	
GS132-8	oil reservoir set screw (2)	
GS384-8	Presser regulating thumb screw	
GL178-8	Presser regulating nut	

PFAFF

G.M. PFAFF
Aktiengesellschaft

Postfach 3020
D-67653 Kaiserslautern

Königstr. 154
D-67655 Kaiserslautern

Telefon: (0631) 200-0
Telefax: (0631) 17202
Internet: www.PFAFF.de