

OPERATING INSTRUCTIONS

SINGER*

MODELS 153B8, 153B8B

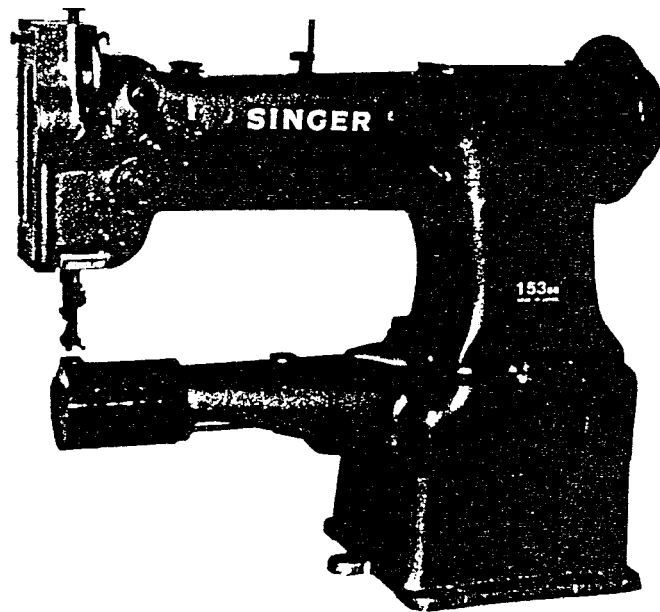

MADE IN JAPAN

SPECIFICATIONS

SPEED: Maximum 3000 r.p.m.
with reverse stitch mechanism 2800 r.p.m.
NEEDLE: Catalog No. 3355
HOOK: Rotating hook
STITCH LENGTH: Maximum 5 mm
SIZE OF BED: 65 X 296 mm
MOTOR: 250W. 2P. clutch motor
DIAMETER OF MOTOR PULLEY: 50 cycle 60 mm
60 cycle 50 mm

CONTENTS

	Page
Setting up the machine	2
Speed	3
Oiling	3
Needle and thread	6
Inserting and removing the bobbin	7
Winding bobbins	8
Threading the machine	9
Regulating the thread tension	10
Regulating the pressure on goods.....	11
Adjusting the stitch length.....	11
Adjusting the lift of the alternating presser feet	12
How to re-set the safety clutch mechanism	12

INFORMATION FOR ADJUSTMENT

Replacement of the timing belt.....	13
Adjusting the height of the feed dog	14
Adjusting the timing of the needle plate, needle and feeder	14
Adjusting the height of the needle bar	15
Timing between the needle and hook	15
Relative position between bobbin case of opener	16
Adjusting the height of the presser feet	16
Timing of the vibrating presser foot	17
Adjusting the thread controller spring.....	17

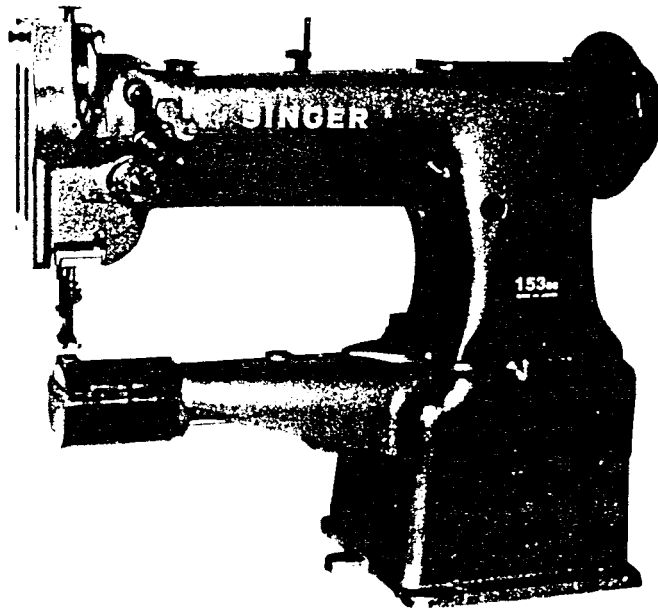

2

SETTING UP THE MACHINE

Before setting up the machine on the table, attach the relative parts to the table.

- | | | |
|------------------|---------------------|-----------------|
| 1. Motor | 2. Stand | 3. Treadle |
| 4. Pedal | 5. Machine rest pin | 6. Cotton stand |
| 7. Machine base | 8. Head | 9. Chain |
| 10. V shape belt | 11. Bobbin winder | |

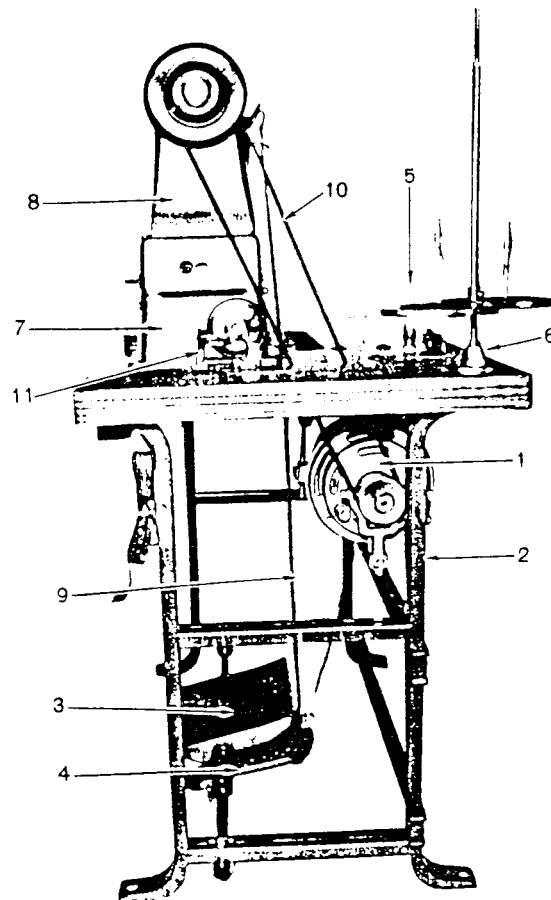

Fig. 1

SPEED

Maximum operating speed after a break-in period is 3000 stitches per minute depending, of course, on the type of material being sewn, its thickness and that of seams being crossed. (With reverse feed 2800 R.P.M.)

To assure durability and trouble-free operation, it is recommended that for the first several weeks of operation the maximum speed is held to not more than 2400 RPM in order to allow the parts to become properly broken in.

In operation the hand wheel of the machine always turns toward the operator.

OILING

Do not operate the machine, even if only for testing, unless it has been properly oiled at every spot requiring lubrication.

The arrows on the Figs. 2, 3, 4 and 5 indicate these spots.

Oiling must be done at least twice daily when the machine is in continuous operation to assure free running and durability of the operating parts.

The hook mechanism should receive careful attention when lubricating the machine.

The oil well beneath the hook should be filled with oil and the felt pad should be soaked with oil. In case of a new machine, oil pad every time a new bobbin is inserted.

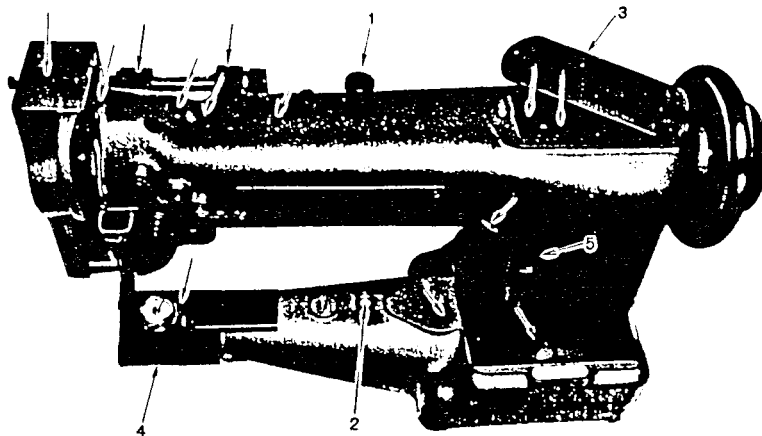

Fig. 2

4

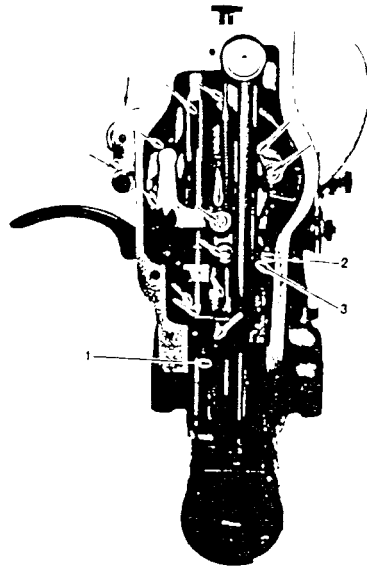

Fig. 3

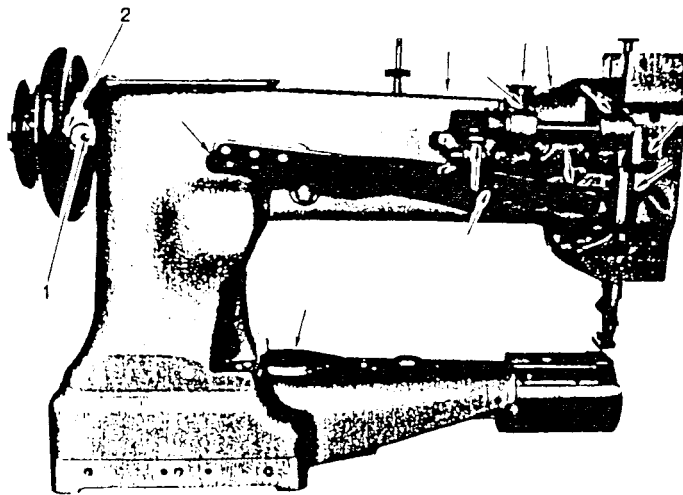

Fig. 4

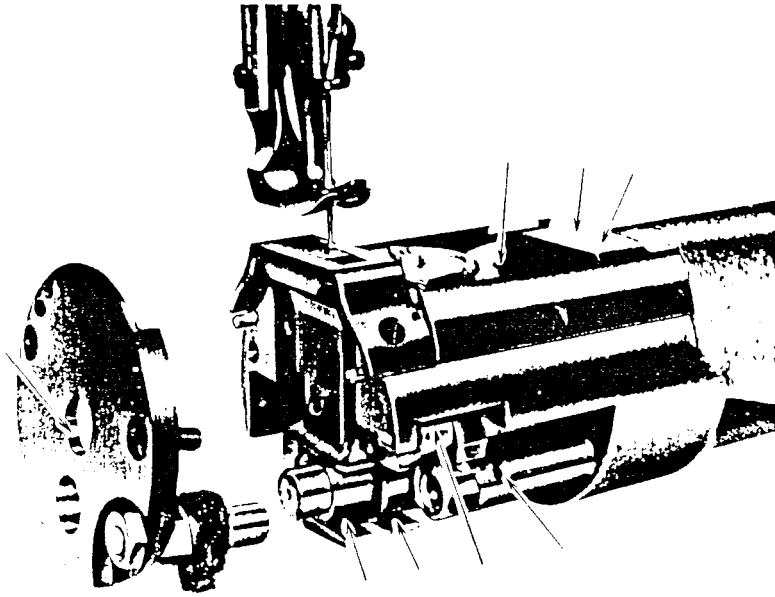

Fig. 5

6

NEEDLE

The machine is set up to use Cat. No. 3355 needles in sizes ranging from 14 to 24.

The thickness of the sewing thread, which must pass freely through the needle eye, determines the size of the needle.

To insert the needle, turn the machine pulley toward you until the needle bar (1) raises to its highest point, loosen the needle set screw (2), and put the needle up into the needle bar as far as it will go, with the long groove of the needle toward the left, and tighten the needle set screw securely.

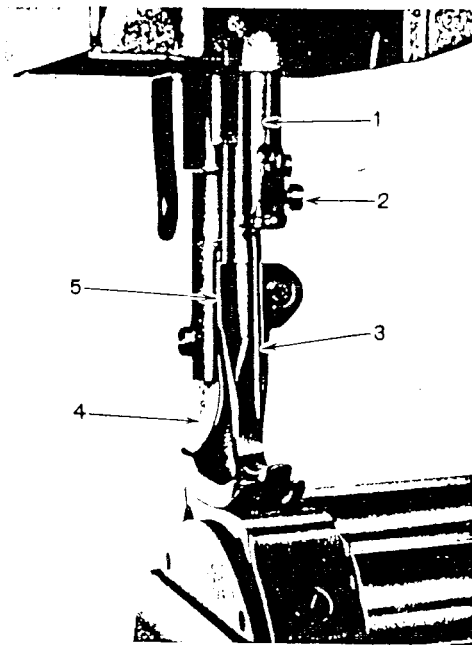

Fig. 7

THREAD

Cotton, synthetic, silk thread can be used according to your sewing purpose, the thickness of thread available is up to #8.

Only left twist thread is to be used for the needle, to test for twist, hold a length of thread between thumbs and index fingers of your hands. Turn the thread counterclockwise.

If it will twist tighter, it has a left twist.

If it unravels, it has a right twist.

The bobbin can be wound with either left or right twist thread.

INSERTING AND REMOVING BOBBINS (Fig. 8)

Raise the needle bar to its highest point. Push open the right-hand cover plate (1, Fig. 8) on the arm of the machine.

Pull up the latch (2, Fig. 8) and lift the bobbin from the bobbin case.

To insert a full bobbin, hold it on one of its sides between thumb and index finger of your right hand.

Be sure that the thread draws out from the bobbins from left to right. Place the bobbin on the center post of the bobbin case and push down the latch (2).

Pull the thread into the slot (3, Fig. 8) inside of the bobbin case and to the left between the bobbin case opener (4, Fig. 8) and a projection (5, Fig. 8) and under the tension spring (6, Fig. 8).

Draw out about 5 cm of the thread on the needle plate and close the cover plate, but leave sufficient space for passage of the thread.

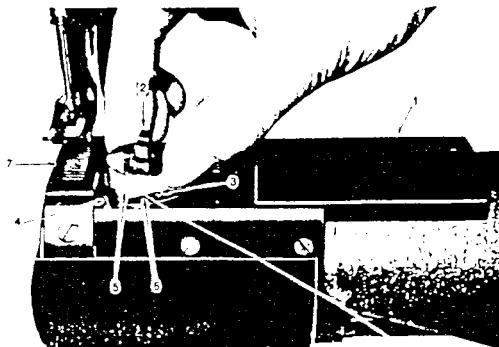

Fig. 8

nging from

gh the

needle
put the
rove of

rpose,

, hold
Turn

8

WINDING BOBBINS

The bobbin winder is mounted on the table top with its pulley in front of the driving belt so that the pulley will separate from the belt after the bobbin has been wound with sufficient thread.

Push the bobbin on bobbin spindle (1, Fig. 10) as far as it will go. Pass the thread from thread stand downward through the eye in the tension bracket. Then between and around the back of the tension discs, bring the thread forward toward the bobbin and wind from below in clockwise direction several times around the bobbin. Push bobbin winder lever (3, Fig. 10) downward until the wheel (2, Fig. 10) contacts the drive belt and start the machine.

After bobbin is filled with thread, release will cause the wheel to disengage from the belt and winding will stop.

Cut the thread and remove the bobbin from the winder spindle.

The adjustment screw (5, Fig. 10) can be turned in or out to increase or decrease the amount of the thread wound on the bobbin.

When fine thread is wound on bobbins, use light tension. It is regulated by turning the knurled nut (6, Fig. 10) on the tension bracket at the rear of the bobbin winder.

Bobbin can be wound while the machine is sewing.

If the thread does not wind evenly on bobbins, loosen the screw (4, Fig. 10) and move the bracket to the right or left as may be required, then tighten the screw.

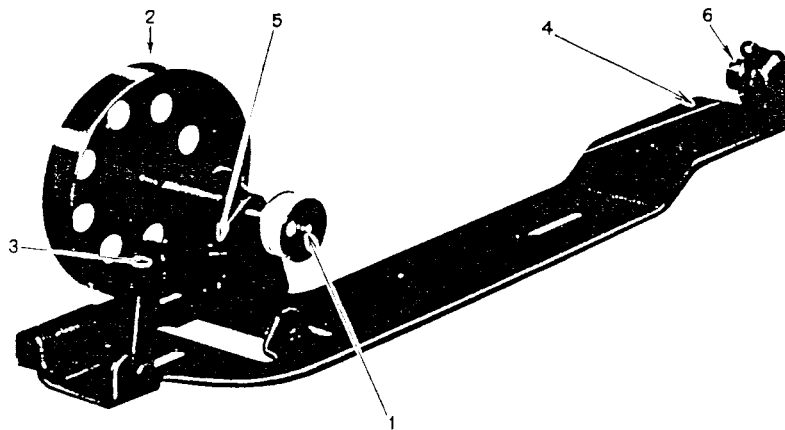

Fig. 10

THREADING THE MACHINE

Raise the needle bar to its highest point.

From the thread stand lead the thread from back to front through the lower guide hole in the spool pin (1) on the top of the machine arm, then again from right to left through the upper guide hole in this pin.

Pass the thread in weaving fashion through the three holes in the guide (2), and from right to left over and between the tension discs (3). Now pull the thread downward and from right to left beneath and around the thread controller (4), continue to pull the thread upward against the pressure of the wire spring into the fork (5) in the thread controller.

Guide upward through the thread guide (6) and from right to left through the eye in the take-up lever (7), down through the thread guide (6) again and then through (8), (9) and (10) from left to right through the eye of the needle.

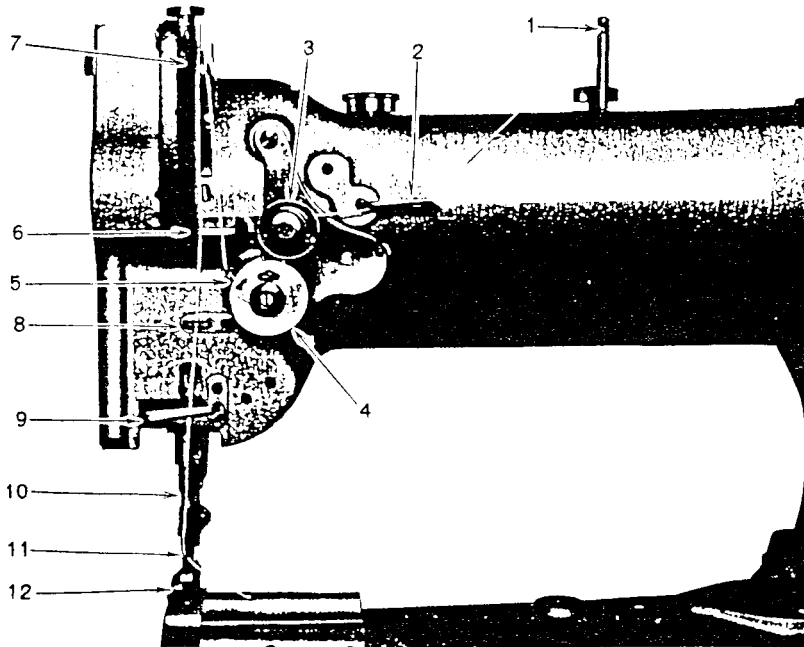

Fig. 11

10

REGULATING THE THREAD TENSIONS

For ordinary stitching, the tension of the upper and lower threads should be equal so as to lock both threads in the center of the fabric. If the tension on either thread is stronger than on the other, imperfect stitching will be the result.

If the tension on the upper thread is greater than that on the lower thread, it will be straight along the upper surface of the fabric.

If the tension on the lower thread is greater than that on the upper thread, the lower thread will lie straight along the underside of the fabric.

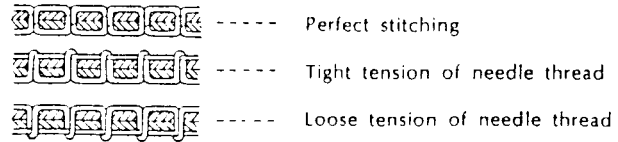

Fig. 12

A. TENSION OF THE UPPER THREAD

To adjust the tension of the upper (needle) thread, turn the serrated nut (1) to the right for increasing tension. If you desire to decrease it, turn the nut to the left.

B. TENSION OF THE BOBBIN THREAD

To increase the tension, turn the screw (1) to the right, and to decrease it turn the screw to the left by a screw driver.

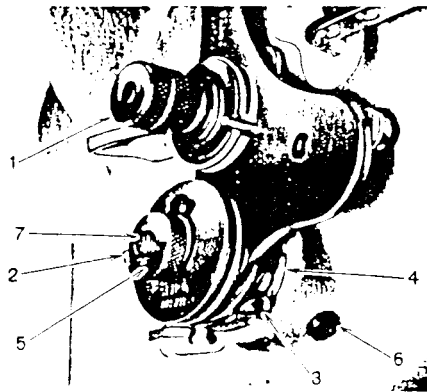

Fig. 13

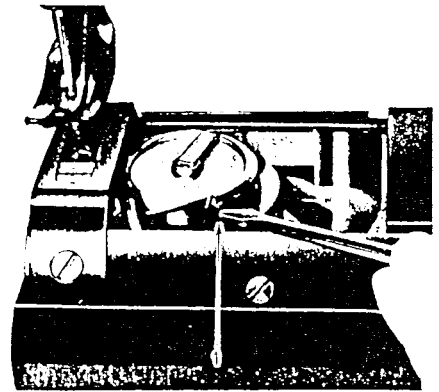

Fig. 14

ADJUSTMENT OF THE PRESSURE ON GOODS

The pressure of the presser feet is regulated by the adjusting screw (1, Fig. 2).

To increase the pressure, turn the screw to the right, and to decrease it to the left.

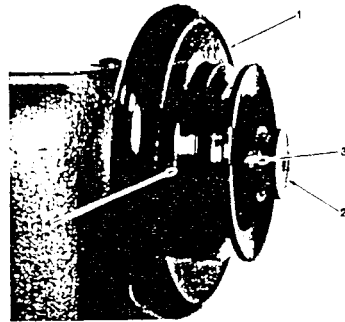

Fig. 15

ADJUSTING THE STITCH LENGTH

The length of the stitch is adjusted by turning the serrated knob (2, Fig. 15). It will be noticed that there is a notch (3, Fig. 15) in this hub wherein appears a number. Same indicates the approximate number of stitches per inch.

On the machine with reverse stitch mechanism, it is adjusted by turning the serrated nut (1, Fig. 16) so that the reference mark on the collar (3, Fig. 16) comes in line with the desired number of stitch length on the plate (2, Fig. 16).

The numerical numbers on the plate show millimeter.

When making reverse stitch, push the lever (4, Fig. 16) down as far as it will go.

Numerals on pulley show number of stitch per inch	Stitch length (m/m)
3	9
4	6.5
5	5
6	4.2
7	3.6
8	3.2
9	2.8
10	2.5
12	2.1
16	1.6
20	1.2
24	1

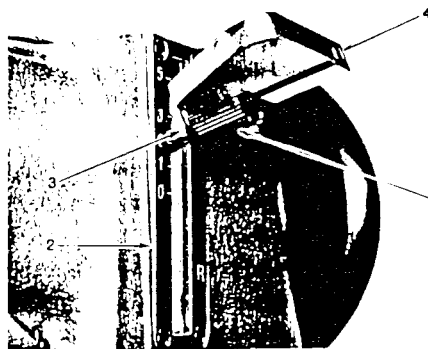

Fig. 16

12

ADJUSTING THE LIFT OF THE ALTERNATING PRESSER FEET

The thickness of the material sewn should control the height of the lift of the alternating presser feet.

It should normally be just high enough for clearance of the material. With normal adjustment both feet lift to equal height.

To adjust the lift, loosen the wing nut (1), move up the nut to raise the lift, and push down this nut to lower the lift.

When altering the lift of the lifting presser foot (4, Fig. 7) unequally against that of the vibrating presser foot (5, Fig. 7) or vice versa, see the instructions "ADJUSTING THE HEIGHT OF THE PRESSER FEET".

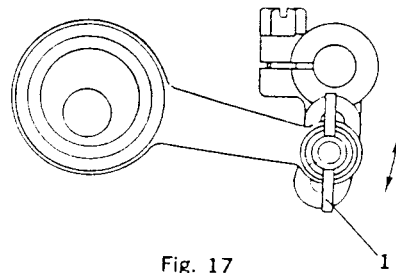

Fig. 17

HOW TO RE-SET THE SAFETY CLUTCH MECHANISM

The sewing hook and its mechanism are protected by a safety clutch. In case the hook gets jammed with thread or other foreign matter, the safety device disengages the driving belt, stops sewing, and thus prevents the machine from getting damaged.

If it should become necessary to re-engage the safety clutch, depress the button (2, Fig. 2) in the bed plate, at the same time, turn the handwheel away from you until the locking mechanism re-engages the driving shaft beneath the bed of the machine, open the slide plate above the hook and rock handwheel back and forth to remove any foreign matter which may have lodged in the hook.

Do not use any sharp-edged tools, lest the hook be damaged.

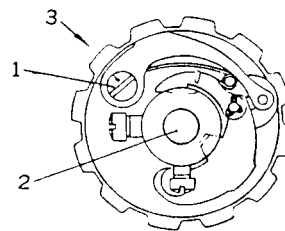

Fig. 18

REPLACEMENT OF THE TIMING BELT

1. INSERTING THE BELT

Turn the hand wheel toward you until the take-up lever reaches to its highest point.

Turn the lower shaft (1, Fig. 19) until the arrow mark on the lower belt pulley (2, Fig. 19) comes in line with another arrow on the timing plate (3, Fig. 19).

Insert a new timing belt into the belt pulley at this position.

2. REMOVING THE TIMING BELT

Move the machine top cover (2, Fig. 3), remove the timing belt from the belt pulley. Loosen the collar set screw (1, Fig. 20), draw out the feed regulating dial (2, Fig. 15) from the arm shaft.

Loosen the two set screws (4, Fig. 15), draw out the hand wheel (1, Fig. 15) from the arm shaft.

Loosen the set screw (1, Fig. 4) and draw out the rear bushing (2, Fig. 4) through the arm hole.

Removing and inserting the timing belt is made through the hole drawn out the rear bushing.

After inserting a new belt, replace the arm top cover, screws to their original places securely.

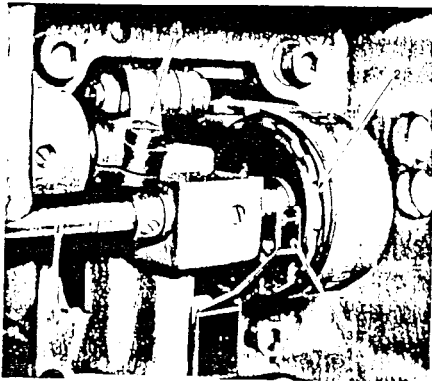

Fig. 19

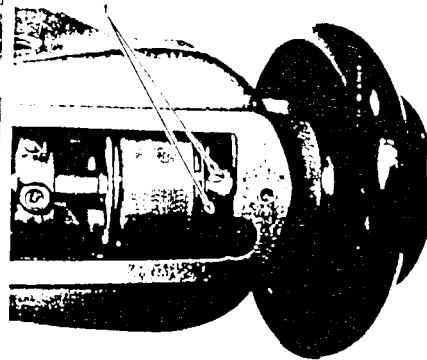

Fig. 20

14

ADJUSTING THE HEIGHT OF THE FEED DOG

The maximum height of the feed dog (1) from the surface of the needle plate (2) is normally 1 mm.

To adjust this height, turn the hand wheel so as to raise the feed dog to its highest point.

Draw out the cylinder (4, Fig. 2).

Loosen the set screw (3), adjust the height of the feeder by raising or lowering it.

Securely tighten the screw and replace the cylinder.

ADJUSTING THE TIMING OF THE NEEDLE PLATE, NEEDLE AND FEEDER

1. RELATIVE POSITION OF THE FEEDER TO NEEDLE PLATE

Adjust the feed motion to the maximum and loosen the screw (4, Fig. 19).

Set the position of the feeder so that both clearances A and B (Fig. 22) are equal before starting feed motion and after finishing the feed.

Securely tighten the screw.

2. THE POSITION OF THE NEEDLE AND NEEDLE HOLE OF THE FEEDER

To adjust this, turn the hand pulley to raise the needle bar to its highest point and put in a perfect needle.

Turning the hand wheel to lower slowly the needle bar, check whether the needle descends to the center of the needle hole of the feeder or not.

If the needle does not enter into the center of the hole, loosen the screw (1, Fig. 23) through the window of the arm (5, Fig. 2).

Holding the bottom of the needle bar rock frame (1, Fig. 3) move it as may be required to get the correct position to the feeder. Then, tighten the screw.

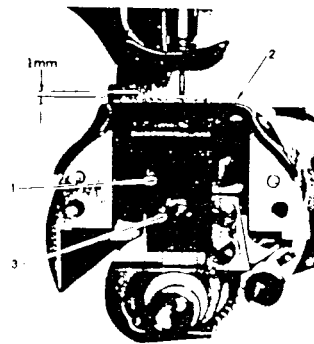

Fig. 21

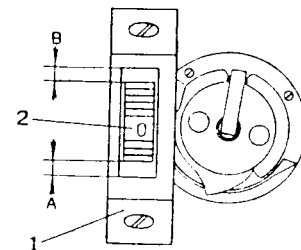

Fig. 22

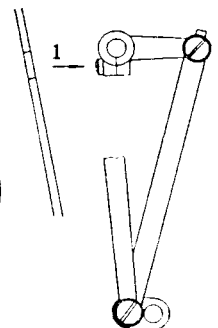

Fig. 23

ADJUSTING THE HEIGHT OF THE NEEDLE BAR

1. When the needle bar is at its highest point, normally the measurement between the surface of the needle plate and the upper end of the needle eye is 21.1 mm.

To adjust this, loosen the screw (2, Fig. 3), move the setting position of the needle bar and needle bar connecting stud (3, Fig. 3) to get the correct position. Then tighten the screw.

2. There is another method for this adjustment by setting the needle bar to its lowest point.

The normal position, in this case, is 4 mm approximately from the hook point to the upper end of the needle eye.

NOTE: These measurements are approximate standard, accordingly, following final adjustments are recommended.

TIMING BETWEEN THE HOOK AND NEEDLE

After setting the needle bar height as stated 1. or 2., confirm as follows:

Set the stitch length to 0, turn the hand wheel to lower the needle bar to its lowest point, turn the hand wheel toward you.

When the needle raises 1.9 mm from the lowest point of its travel, normally the hook point is at the center of the needle and the measurement between the hook point and the upper end of the needle eye should be 2.1 mm, furthermore the clearance between the hook point and the needle hollow should be about 0.05 mm to 0.2 mm.

If they are not measured as above, adjustments are made as follows:

1. TIMING ADJUSTMENT

Loosen three set screws (1, Fig. 25), set the correct timing by moving the hook. Then tighten the screws securely.

2. ADJUSTING THE CLEARANCE

Loosen the screw (2, Fig. 25) and the set screw (1, Fig. 25).

Move the hook saddle (3, Fig. 25) to the right or left to get the proper clearance and tighten the screws.

Be sure to use perfect needle.

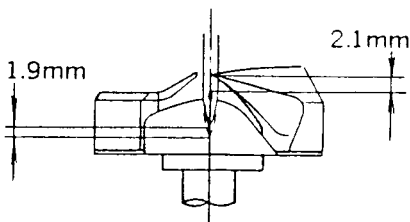

Fig. 24

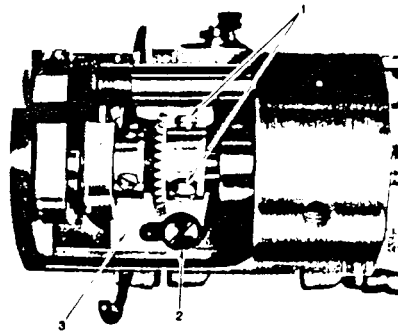

Fig. 25

16

RELATIVE POSITION BETWEEN BOBBIN CASE AND OPENER

1. Loosen the screw (1), turn the hand wheel until the opener (2) is located at the extreme right hand position of its travel.
2. In this position, adjust it so that the clearance between the inside edge of the opener and the tab on the bobbin case holder is about 0.2 mm.

After the adjustment, tighten the screw.

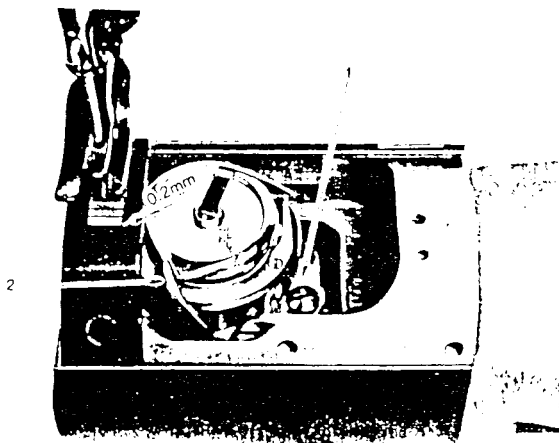

Fig. 26

ADJUSTING THE HEIGHT OF THE PRESSER FEET

1. ADJUSTMENT BY THE PRESSER BAR LIFTER

Loosen the screw (1, Fig. 2) sufficiently, raise the presser bar lifter and loosen the set screw (1, Fig. 27).

Move the lifting presser foot (4, Fig. 7) up or down as may be required so as to get the correct height and tighten the screw.

2. ADJUSTING THE LIFT OF ALTERNATING PRESSER FEET

If the height of the lifting presser foot changes, the momentums of the lifting and vibrating presser foot vary, thus the height of the vibrating presser foot must be adjusted.

A. Lower the presser bar lifter, holding the vibrating presser foot (5, Fig. 7), loosen the hexagon screw (2, Fig. 27) and move the presser foot up or down as may be required.

B. After setting the position, tighten the screw.

Normally, the momentums of the alternating presser feet are adjusted to equal, but for piping work, it is effective to adjust less momentum of the vibrating presser foot than that of the lifting presser foot.

TIMING OF THE VIBRATING PRESSER FOOT

Turn the balance wheel toward you, after lowering the presser bar lifter, the vibrating presser foot should reach the feeder earlier than the needle eye and when the needle raises, the vibrating presser foot should leave the feeder after the needle eye has left the feeder.

The vibrating presser foot must tightly hold the goods while the needle is passing the goods for avoiding irregular stitches.

To adjust this, set the lift of the alternating presser feet so that they are equal, loosen the two screws (3, Fig. 27) and adjust the rotating position of the cam (4, Fig. 27) faster or slower as may be desired, and tighten the screw.

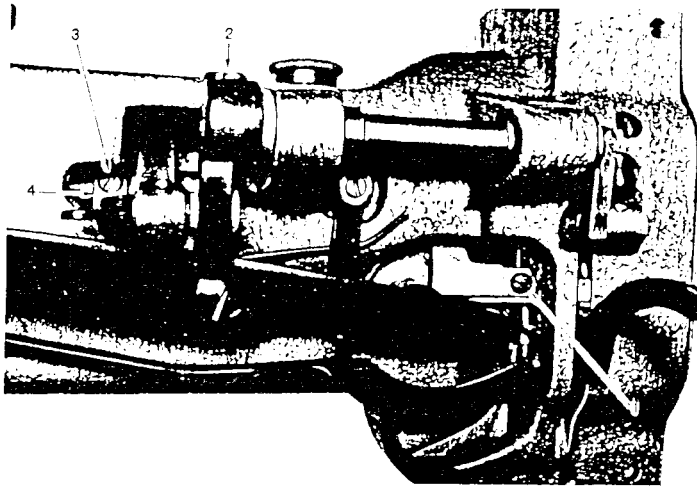

Fig. 27

ADJUSTING THE THREAD CONTROLLER SPRING

Normally the thread controller spring (2, Fig. 13) should take up the slack of the upper thread until the needle reaches the goods, and it should pause while the needle raises and the upper thread passes through the bobbin case.

For more controlling action on the thread, loosen the stop screw (3, Fig. 13) and move the stop (4, Fig. 13) to the right.

For less action, set the stop to the left. Then tighten the screw.

To strengthen the tension of the spring, loosen the serrated nut (5, Fig. 13), loosen the screw (6, Fig. 13) and turn the tension stud (7, Fig. 13) slightly to the left with a screw driver, or to lighten the tension, turn to the right.

Then tighten the screw and nut.