

SINGER
CLASS 240W

USE ONLY **SINGER*** OILS and LUBRICANTS

*They insure freedom from lubricating trouble and give
longer life to sewing equipment*

*The following is the correct lubricant for
Machines of Class 240w:*

TYPE C — MANUFACTURING MACHINE OIL, LIGHT GRADE

OTHER **SINGER** LUBRICANTS

TYPE E — THREAD LUBRICANT

For lubricating the needle thread of sewing machines for stitching fabrics or leather where a thread lubricant is required.

TYPE F — MOTOR OIL

For oil lubricated motors and plain bearings in power tables and transmitters.

NOTE: All of the above oils are available in 1 quart, 1 gallon and 5 gallon cans.

BALL BEARING LUBRICANT

This pure grease is specially designed for the lubrication of ball bearings and ball thrust bearings of motors and electric transmitters, ball bearing hangers of power tables, etc. Furnished in 1 lb. and 4 lb. tins.

3094w

ADJUSTERS MANUAL FOR **SINGER*** SEWING MACHINES OF **CLASS 240w** SINGLE THREAD CHAIN STITCH

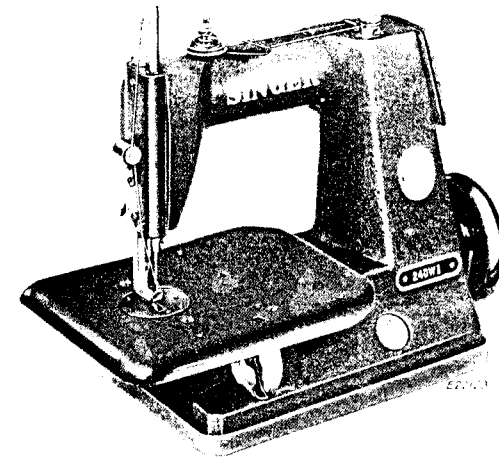

Machine 240w1

—
*A TRADE MARK OF

THE SINGER MANUFACTURING COMPANY

TO ALL WHOM IT MAY CONCERN:

3

The improper placing or renewal of the Trade Mark "SINGER" or any other of the Trade Marks of The Singer Manufacturing Company (all of which are duly Registered Trade Marks) on any machine that has been repaired, rebuilt, reconditioned, or altered in any way whatsoever outside a SINGER factory or an authorized SINGER agency is forbidden.

THE IMPORTANCE OF USING SINGER* PARTS AND NEEDLES IN SINGER MACHINES

The successful operation of SINGER machines can only be assured if SINGER parts and needles are used. Supplies are available at all SINGER Shops for the Manufacturing Trade, and mail orders will receive prompt attention.

SINGER Needles should be used
in SINGER Machines
These Needles and their Containers
are marked with the
Company's Trade Mark "SIMANCO." 1

Needles in Containers marked
"FOR SINGER MACHINES"
are NOT SINGER made needles. 2

Copyright, U. S. A., 1953, by The Singer Manufacturing Company
All Rights Reserved for all Countries

DESCRIPTION

Machines of Class 240W are single needle, single thread chain stitch machines with a rotary looper, embodying various thread controlling features to suit the variety of work for which they are designed.

Machine 240W1, illustrated on page 1, has a plain tension, a thread nipper, and a face plate thread retainer as means for controlling the thread required in stitching. The stitch range of this machine is from 7 to 30 stitches per inch.

Machine 240W2, in addition to the above features, has a thread measuring device which measures off a pre-determined length of

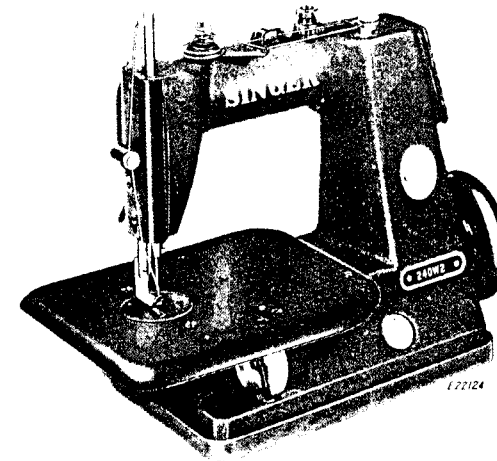

Fig. 2. Machine 240W2

thread for each stitch and relieves the needle bar take-up of its normal secondary function of pulling thread from the cone or spool. This machine has the same stitch range as the 240W1.

Machine 240W3 has a plain tension and a face plate thread retainer to control the thread for stitching. This machine is usually

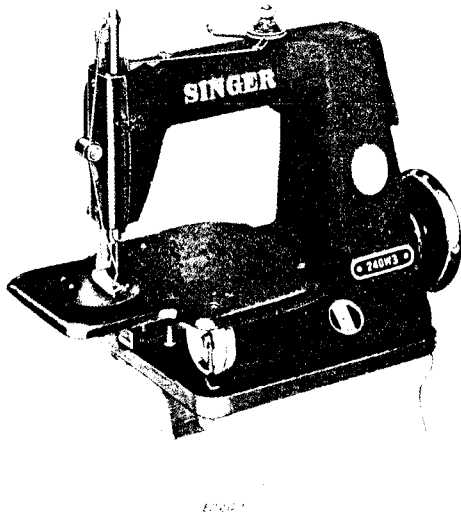

Fig. 3. Machine 240W3

used where great differences in thread demands are encountered in one seam. The cloth plate is reduced in the work area to accommodate cylindrical work, and the base length is reduced to provide extra clearance under the cloth plate. This machine is usually mounted on a 2" or 3" high wood base to enable the operator to utilize more fully the aforementioned clearances. The stitch range of this machine is from 4 to 16 stitches per inch.

Machine 240W4 has a thread measuring device, edge guiding presser foot and a thread cutter on the looper. This machine is especially adapted for the attachment of labels and has the same stitch range as the 240W1.

SPEED

Speed up to 5000 R.P.M. depending on materials used and operations performed.

It is advisable to run a new machine slower than maximum speed for the first few minutes to allow time for the oil to reach moving parts. The top of the driving wheel turns away from the operator.

Unless otherwise stated, all future references apply to **all** varieties of this class machine.

SETTING UP

The machine rests on resilient mounts in a mounting tray on locating pins, as shown in **Fig. 4**, and may be driven with either a round or a "V" belt. The use of a "V" belt provides better machine acceleration than that given by a round belt.

The 240W machine is normally mounted directly to the table top, or, as is the case with the 240W3, mounted on a simple wood base to provide the extra clearance under the cloth plate required in the cap or millinery industry.

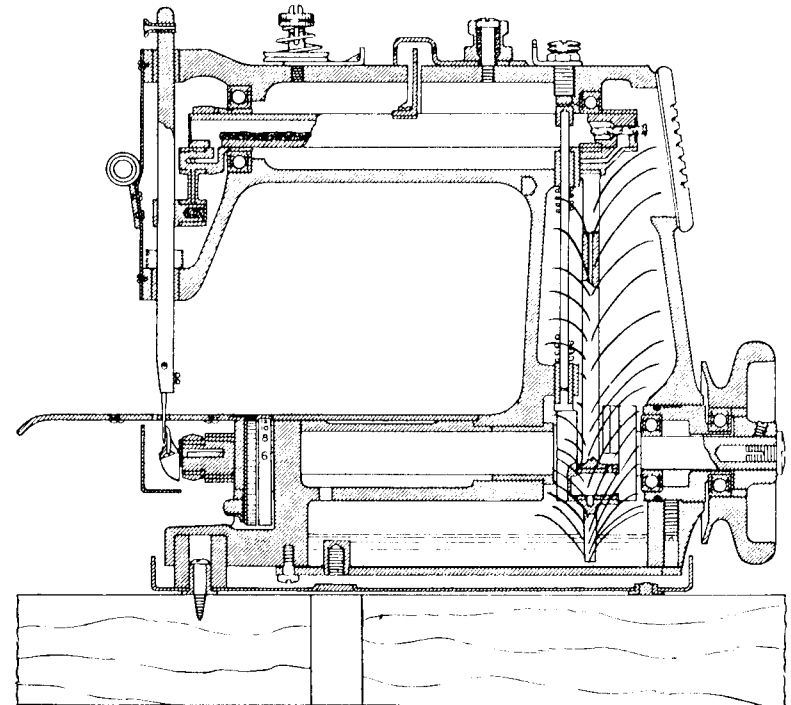

Fig. 4. Cross Section View of 240W Machine

To attach the 240W1, 240W2 or 240W4 to the table top, place the machine in the mounting tray and set tray on the table top with the center of the belt groove in the driving wheel directly in line with the center of the pulley on the driving equipment, and the edge of the cloth plate from three to four inches from the front of the table. This distance will vary with operator preference. Mark tray location, remove machine, and secure tray in place using four 1-1/8" No. 8 round head wood screws.

After replacing machine, bore a 5/8" diameter hole vertically through the table directly below the presser bar lifting rock shaft

crank to which the knee lifter (or foot lifter) chain attaches, as shown in Fig. 5. Attach the chain to the crank with an "S" hook and drop chain down through the hole. Secure knee lifter (supplied with each machine) to bottom of table using three 3/4" No. 12 round head wood screws with the knee pad located 6-1/2" to

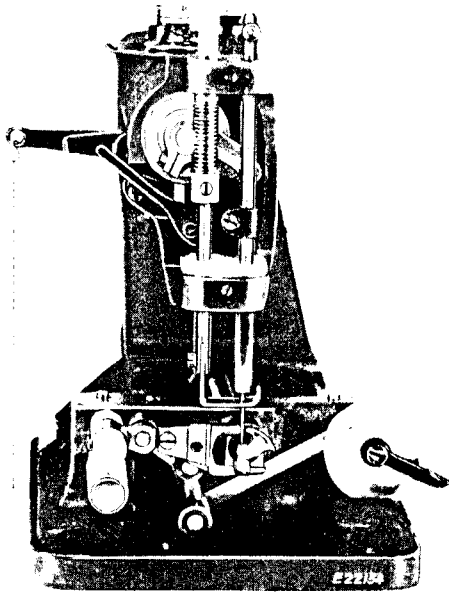

Fig. 5. Showing Knee Lifter (or Foot Lifter) Chain Connection.

the right of the needle center line. Adjust the knee lifter stop to permit the presser foot to be raised 5/16". The entire knee lifter plate may be moved toward or away from the front edge of the table within the adjustment range of the sliding rod. Rotate this rod until an "S" hook through its end lies just below the hole in the table. Attach chain with a **small** amount of slack.

If a SINGER transmitter is employed, use a 3/8" wide "V" belt to drive the machine. If line shafting is employed, use a 5/16" round leather belt. If a round belt is used, it is advisable to submerge the belt clip so that it will not strike the driving wheel.

To mount the 240W3, the same procedure is followed except that the machine is first placed in its mounting tray, the tray on the wood base, and the base on the table top, as shown in Fig. 3. Locate the belt groove of the driving wheel above the center of the pulley on the driving equipment and the edge of the cloth plate at the desired distance from the edge of the table. Mark the base's position on the table, remove the machine and tray, and secure base to the table top with four 2" No. 8 flat head wood screws. Secure tray to base and proceed as previously recommended.

TO LUBRICATE THE MACHINE

This class machine does not require oil-can lubrication by the operator. The bed of the machine is an oil reservoir from which all moving parts within the frame are automatically lubricated by splash, and the three major frame openings directly in contact with the oil are gasketed. It is imperative that TYPE "C" OIL, sold only by Singer Sewing Machine Co., be used exclusively to ensure proper flow through the bearings. For description of this oil, see inside front cover of this book.

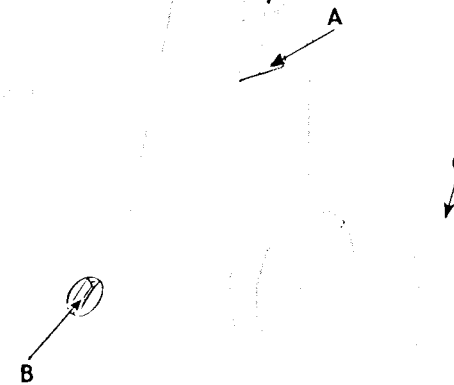

Fig. 6. Showing Oil Gauge B and Filling Point A for Oil Reservoir

Before starting the machine, remove the cover **C**, Fig. 6 and fill the oil reservoir through opening **A** to the top red line on the gauge **B**. Replace cover **C** and securely tighten its four screws.

Approximately 4-1/2 fluid oz. of oil are initially used in filling the bed reservoir and the oil level should be maintained between the two red lines on the sight gauge **B**, Fig. 6. Check the oil level when the machine is not running. When the machine is running, bubbles will be observed travelling thru the oil sight gauge. This is normal.

Under no circumstances allow the level to drop below the bottom red line. The addition of oil should not be necessary more than once every few months.

NEEDLES

Depending on the nature of the work to be stitched, use needles of Class and Varieties listed below:

CLASS AND VARIETY OF NEEDLES	SIZE Nos.
24x1	7, 8, 9, 10, 11, 12, 13, 14, 16, 17, 18, 19, 21, 22, 23, 24, 25, 27
24x2	7, 8, 9, 11, 13, 14, 16, 17, 18, 19, 21, 22, 23, 24, 25
24x3	7, 8, 9, 11, 12, 14, 16, 18, 19, 21, 22, 23, 25
24x5	9, 11, 13, 14, 16, 17, 18, 19, 21, 22
24x7	7, 8, 9, 11, 13, 14, 16, 17, 18, 19, 21, 22, 23, 24, 25
24x9	9, 11, 13, 14, 16, 17, 18, 19
24x11	7, 8, 9, 11, 13, 14, 16, 17, 18, 19, 21, 22, 23, 24, 25
24x13	8, 9, 11, 13, 14, 16, 18
24x15	8, 9, 11, 14, 16, 18

24x2 is recommended for sewing leather while all others may be used on fabrics and plastics in general.

The size of the needle to be used is determined by the size of the thread which must pass freely through the eye of the needle. Rough or uneven thread, or thread which passes with difficulty through the eye of the needle will interfere with the proper operation of the machine.

Orders for needles must specify the QUANTITY desired, the SIZE number, also the CLASS and VARIETY numbers separated by the letter X.

The following is an example of an intelligible order:

100 No. 11, 24x15 Needles

The best stitching results will be obtained with needles sold by Singer Sewing Machine Company.

TO SET THE NEEDLE

Turn the top of the driving wheel over from you until the needle bar moves to its highest point; loosen the screw at the lower end of the needle bar and put the needle up into the bar as far as it will go, with the long groove of the needle toward the left and the eye of the needle directly in line with the arm of the machine, then tighten the screw.

Needles with a flat on the shank should be positioned with the flat toward the needle set screw.

THREAD

Either left twist or right twist thread may be used on these machines. It should prove more economical over a period of time to use a good grade of thread.

THREADING

Each variety of machine must be threaded as shown in the following illustrations:

Fig. 7
Threading
Machine 240W1

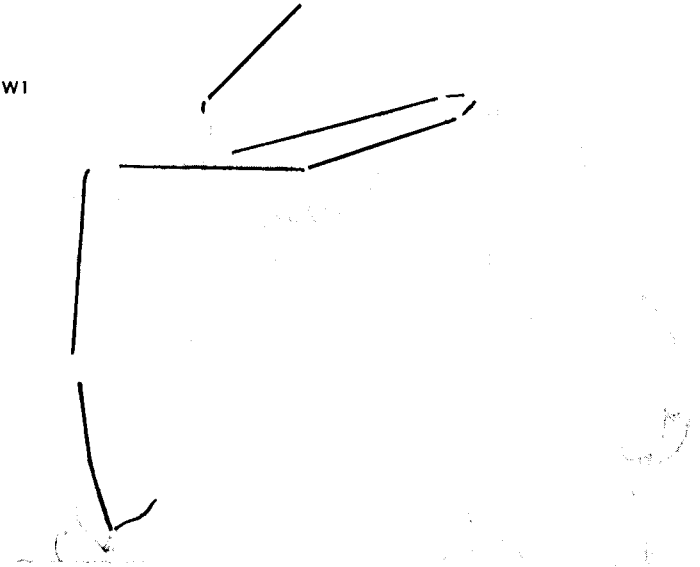
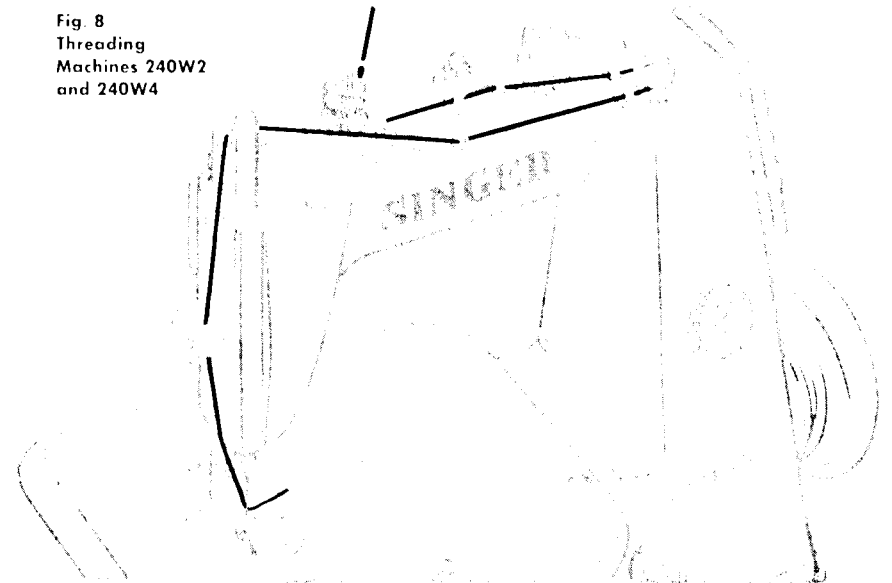

Fig. 8
Threading
Machines 240W2
and 240W4



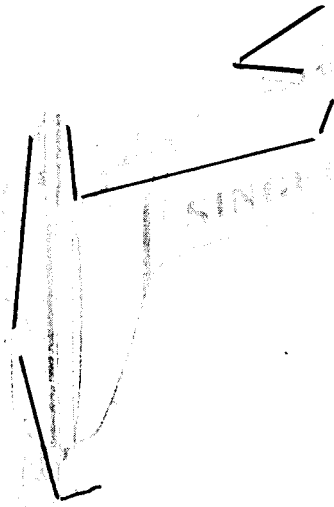

Fig. 9. Threading Machine 240W3

TO COMMENCE SEWING

Place the material beneath the presser foot, lower the presser foot and commence to sew, turning the top of the driving wheel away from you.

TO FASTEN OFF THE STITCHING OFF THE WORK MACHINES 240W1 TO 240W3

Sew two or more stitches past the end of the seam and stop the needle bar at its highest point, then with the left hand draw about three inches of thread through the tension discs. With the right hand draw the slack thread through the eye of the needle, then pull the thread upward from the work, the presser foot being down, and cut the thread close to the material. Raise the presser foot, pull the work from you and the end of the thread will be drawn through the loop; then pull the end of the thread to fasten, as shown in Fig. 10.

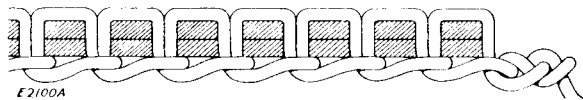

Fig. 10. Stitching Fastened at the End of a Seam

TO FASTEN OFF THE STITCHING IN THE WORK MACHINES 240W1 TO 240W3

When it is necessary to fasten off the last stitch in the work, stop the machine with the needle in the work, place the fingers on the material close to the presser foot to prevent the work from moving, raise the presser foot and take one more stitch in the last hole made, see Fig. 11, and stop the needle bar at its highest point,

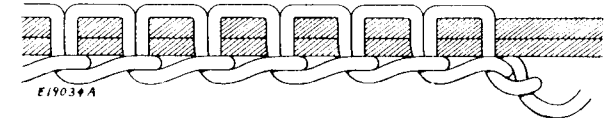

Fig. 11. Stitching Fastened off in the Work

then with the left hand draw about three inches of thread through the tension discs. With the right hand draw the slack thread through the eye of the needle, then pull the thread upward from the work and cut the thread close to the work.

Pull the work from you and the end of the thread will be drawn through the loop; then pull the end of the thread to fasten, as shown in Fig. 11.

TO REMOVE THE WORK MACHINE 240W4

Turn the driving wheel away from you until the needle reaches the highest point and is just starting down. This brings the thread behind the thread cutter on the back of the looper (the action of the thread may be observed under the cloth plate). Turn the driving wheel toward you to cut the thread while drawing the work away from you.

TO TAKE OUT A SEAM

The seam can be readily taken apart without injury to the material by unfastening the last stitch and drawing out the thread in the opposite direction to that in which the seam was sewed.

In cases where both ends of a seam are likely to be trimmed, as in fitting a garment, etc., always begin the seam at the end which is sure to be trimmed; at the other end reverse the work and stitch back sufficient distance to allow for trimming.

To remove a partially sewed seam while the work is still under the presser foot, turn the driving wheel backwards two stitches, (this, and when using a thread cutting looper for label sewing, are the only times turning the wheel backwards is permissible.) Raise the presser foot and remove the work. The stitching should leave the cloth easily.

TO REGULATE THE THREAD TENSION

Turn the small nut **D**, Fig. 12 above the tension spring in the direction indicated in Fig. 12 to increase or decrease the pressure

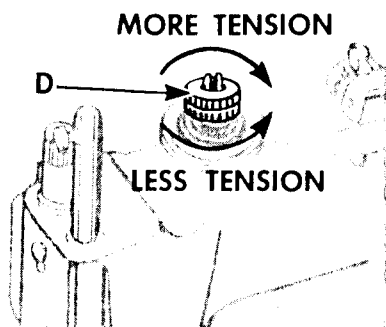

Fig. 12. Thread Tension Regulator

on the tension discs. On **Machines 240W2** and **240W4**, sufficient tension should be maintained so that the graduations on the thread measuring device closely correspond to the number of stitches per inch setting showing through the cloth plate opening.

TO REGULATE PRESSURE ON THE MATERIAL

The pressure of the presser foot on the material is regulated by a thumb screw **E**, Fig. 13 adjacent to the top of the needle bar.

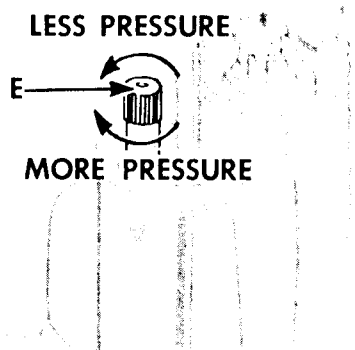

Fig. 13. Regulating Pressure on Material

To increase or decrease the pressure, turn this screw as indicated in Fig. 13. It is advisable to use the lightest pressure possible on the work which will permit satisfactory feeding of the material.

TO REGULATE THE LENGTH OF STITCH

To obtain a desired stitch length, raise the locking tab **F**, Fig. 14 on the stitch regulating wheel and turn the wheel until the number of stitches per inch desired appears in the opening **G**,

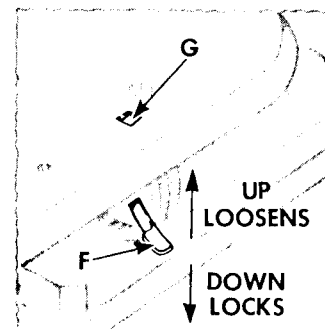

Fig. 14. Stitch Regulator

Fig. 14 in the cloth plate. Press locking tab downward to secure the feed at this figure. On **Machines 240W2** and **240W4**, the thread measuring device should be regulated correspondingly, see Fig. 15.

TO REGULATE THE THREAD MEASURING DEVICE MACHINES 240W2 AND 240W4

Rotate the knob **H**, Fig. 15 so that more thread is measured off for longer stitches (or smaller number of stitches per inch) and less thread for the shorter stitch (or larger number of stitches per inch). The numbers on the knob should correspond approximately to the number of stitches per inch to be sewed.

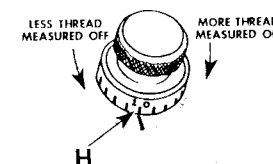

Fig. 15. Threading Measuring Device on Machines 240W2 and 240W4

TO ADJUST THE FACE PLATE THREAD RETAINER

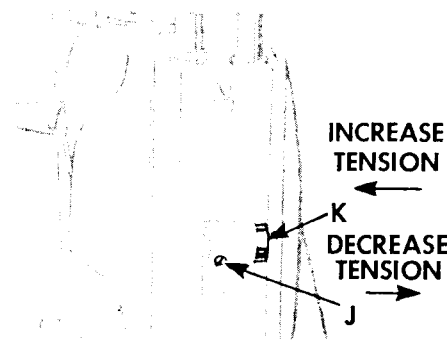

Fig. 16. Face Plate Thread Retainer

When a different amount of tension is desired on the face plate thread retainer from an existing setting, loosen set screw **J**, Fig. 16 and position the center stud **K**. Tighten the set screw **J**. Moving the stud **K**, as shown, increases or decreases the tension. This retainer controls the thread between the work and the take-up.

TO CLEAR THREAD FROM THE LOOPER

To clear thread from around the looper, swing the looper guard by its tab **L**, Fig. 17 to the left and backward, clear looper, and snap guard back into place. To prevent personal injury or material damage, it is essential that this guard be kept closed at all times when access to the looper is not required.

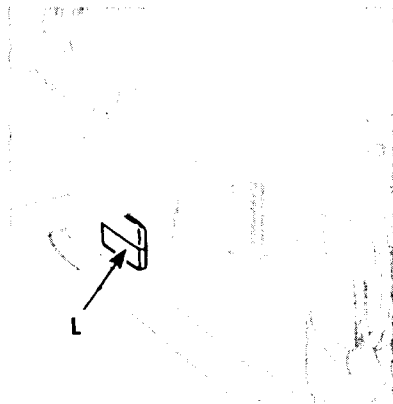

Fig. 17. Showing Looper Guard

RECOMMENDATIONS FOR PROPER OPERATION

The top of the driving wheel must always turn away from the operator during normal sewing.

Do not run the machine with the presser foot resting on the feed without cloth under the presser foot.

Do not try to help the machine by pulling the fabric lest you bend the needle. The machine feeds the work without assistance.

The guard around the looper should be kept closed when the machine is in operation.

Do not press the knee lifter lever while the machine is in operation, as this might prevent the work from feeding properly.

Occasionally remove the accumulation of lint from around the looper and from between the feed rows beneath the throat plate.

Do not run the machine with the needle threaded unless there is material clamped under the presser foot.

TIMING THE MACHINE

All eccentrics in the 240W machines are fixed and cannot drift out of adjustment. These include thread measuring, thread nipper, and feed timing. The looper shank has a flat so that it can be placed properly in the looper shaft in only one position.

PRESSER BAR ADJUSTMENTS

If adjustment of the presser foot is desired to centralize the slot about the needle, remove the face plate and loosen the set screw **M**, Fig. 18 in the presser bar lifting bracket and rotate the presser bar until the foot is centrally located. Tighten set screw. If the bottom of the presser foot does not lie flat against the throat plate when the feed dog is below the surface, loosen the set screw **M**, press the foot flat down on the plate, raise the presser bar lifter slightly and tighten set screw. This will ensure pressure on the foot and prevent the presser bar lifting bracket from striking the presser bar lifter during normal sewing.

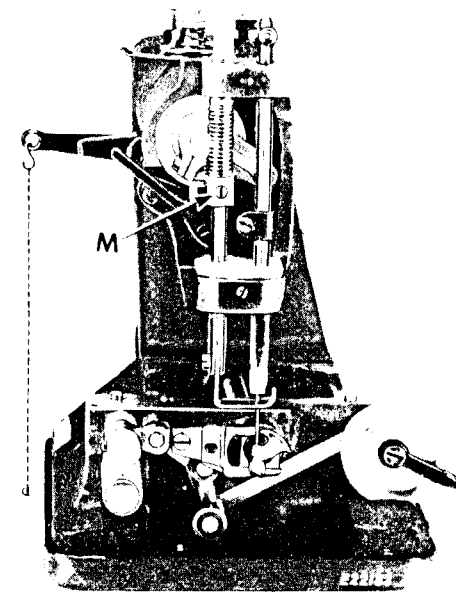

Fig. 18. Adjustment of Presser Bar

TO SET THE NEEDLE BAR HEIGHT

First check to be sure needle shank is in the needle bar hole as far as it can go. Remove the cloth plate. Turn the driving wheel until needle bar is at its lowest position. The timing mark about 1/2" from the top of the needle bar, should be just visible above the casting. If the needle is not correctly set with respect to looper point (for most work, the bottom of the looper point should be .010"-.015" above the top of the needle eye), see Fig. 19, loosen

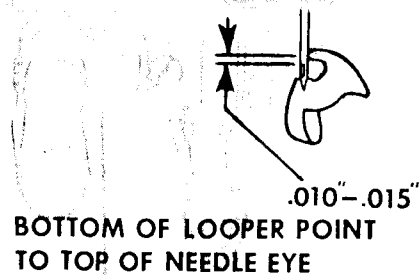

Fig. 19. Showing Correct Relationship of Needle and Looper

needle bar clamping screw and move the needle bar to the correct position. When the correct height is set, be sure thread tube at top of bar is parallel to the arm before tightening clamping screw.

TO REMOVE THE LOOPER

Remove the needle and the cloth plate, and rotate looper shaft until the point of the looper is at its highest position. Loosen both looper set screws **O**, Fig. 20 sufficiently to allow the looper to slide

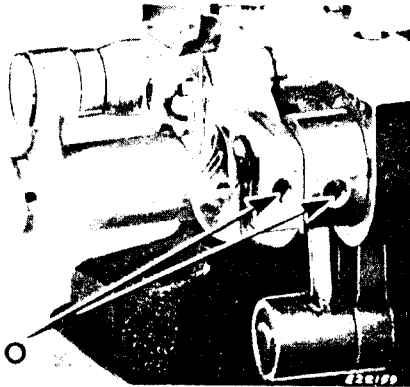

Fig. 20. To Remove Looper

out easily without disturbing the feed dog setting. Do not rotate the looper shaft while the set screws are loose, since scoring of the feed bearing surfaces is possible. To install a looper, reverse the procedure. To set the looper to the needle, loosen both screws slightly, slide the looper until the point is just short of touching the needle (after the height of the needle bar has been correctly set), then tighten the screws.

TO REMOVE THE LOOPER SHAFT

To remove the looper shaft, remove the needle, cloth plate, the looper, and then turn the looper set screws all the way in. Remove frame end cover held by four screws, and drain reservoir oil through

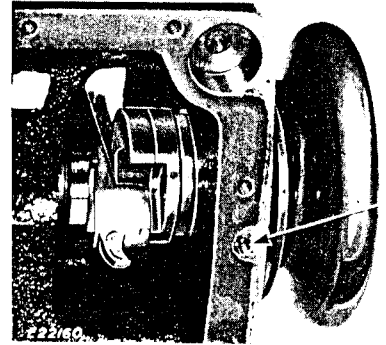

Fig. 21

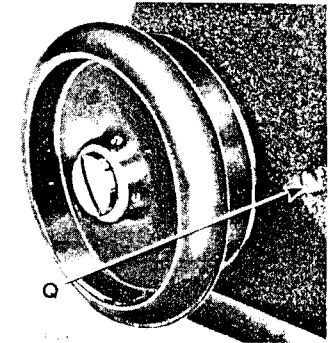

Fig. 22

this opening into a container. Remove oil reservoir cover held by twelve screws. Loosen and unscrew several turns, the bottom set screw **P**, Fig. 21 and rear set screw **Q**, Fig. 22 holding the driving wheel assembly. Pull assembly out, rotating the wheel back and forth as the pull is exerted. Swing the needle bar driving connection to the back of the machine and withdraw the looper shaft, being careful on the 240W1, 240W2 and 240W4 to hold hand over rear bearing area to prevent nipper rod and spring loss when the shaft is withdrawn.

To replace the shaft, press nipper rod up into frame and hold through upper rear frame opening. Insert looper shaft and release nipper rod. Swing connection into place, and insert driving wheel assembly. It is advisable to replace the neoprene ring seal each time the assembly is removed and reinstalled to ensure a tight oil seal after assembly. Press assembly in just enough to allow the connection the slightest axial movement (see Fig. 21). Secure both set screws lightly, then tightly. Replace oil reservoir cover, oil and frame end cover. The oil level should be at the upper red line on the oil level indicator.

TO ADJUST THE NIPPER (240W1, 240W2 and 240W4)

The thread nipper is actuated by a rod which bears on a fixed eccentric for its timing, therefore, the adjustment lies merely in changing the duration of nipper opening. This is made by screwing the nipper down against the nipper rod for a greater time interval and up away from the nipper rod for a lesser time interval, which means that raising the nipper causes it to open later and close earlier while lowering the nipper causes it to open earlier and close later. It is always fully open when the needle bar is at its highest position.

To adjust the thread nipper, place a screwdriver in the slot of screw **R**, Fig. 23 and hold, while loosening the lock nut **S**, Fig. 23 slightly. Turn the screw either way and lock the nut. Before tightening the locknut, be sure the nipper thread guide is positioned so that the thread from the nipper travels in a straight path through the tension thread guide hole to the needle bar thread tube.

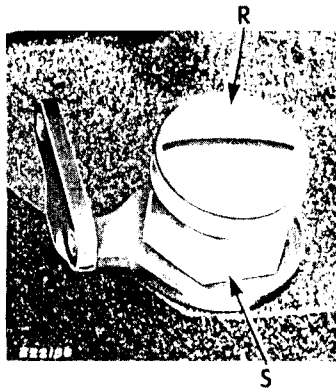

Fig. 23. Adjustment of Thread Nipper

TO ADJUST THE FRICTIONING OF THE FEED REGULATING WHEEL (INDEXED)

The feed regulating wheel **T**, Fig. 24 through levers, rotates a shaft when changing stitch length. The force required to rotate the wheel is regulated by a set screw on a split bushing around this shaft. To change this force, remove the lock screw at **X**, Fig. 24, exposing a set screw. Adjust this set screw for more or less friction on the shaft, then replace and tighten the lock screw.

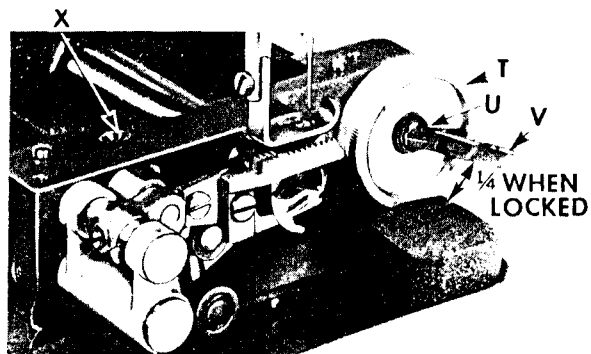

Fig. 24. Adjustment of Feed Regulating Wheel

TO REMOVE OR ADJUST FEED REGULATING LOCK SCREW LEVER

To remove the lock lever **V**, Fig. 24, hold lever down and remove cap screw **U**, Fig. 24. To replace or adjust the lock lever, make sure that screw with serrated head is tight, hold lever **V** in position (bottom of the lever about 1/4" from the casting), as shown in Fig. 24, and replace cap screw.

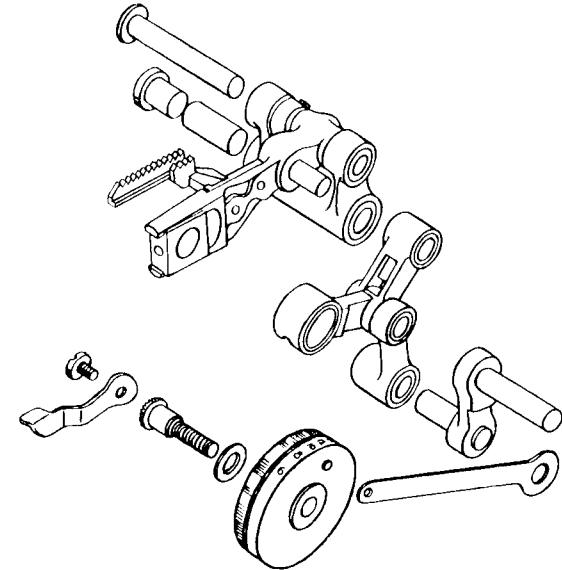

Fig. 25. Exploded view of Feeding Mechanism

TO ADJUST THE THROAT PLATE

The slots in the throat plate should be parallel with the line of feed. If they are not, remove the cloth plate, and loosen the two throat plate clamping screws on the bottom of the cloth plate. Place cloth plate on the two locating pins (don't put 3 screws in yet) and position the throat plate. While holding the throat plate and cloth plate together, remove the cloth plate and tighten the two screws. Replace the cloth plate.

NOTE

Whenever the cloth plate is off the machine, remove lint from around the feed links.

ADJUSTMENT OF THE FEED DOG

The feed dog may be moved up and down, in and out, back and forth and tilted.

If the feed dog rows lie to one side of the throat plate slots, and there is no general sideward play in the feed, loosen set screw **B2**, **Fig. 26** on back of the feed bar, adjust bar to centralize the feed dog and tighten set screw.

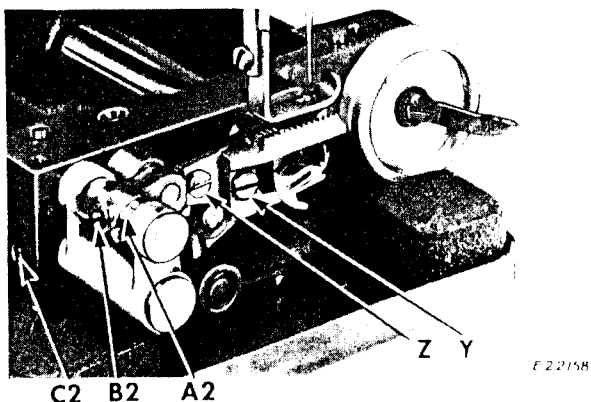

Fig. 26. Adjustment of Feed Dog

If the feed dog is too high or too low, loosen the feed dog clamping screw **Y**, **Fig. 26** and correct the height. Tighten the screw.

If the feed dog is not central with respect to back and forth travel, loosen the screws **Y** and **Z** slightly, and push the adjusting plate either way to correct the condition being careful not to change the tilt of the feed dog. Tighten the screws.

If the tilt of the feed dog is questioned, it may be checked by turning the driving wheel until the feed dog reaches its highest position. Lower the presser foot to the feed dog. The top of the feed dog should be level and flat against the presser foot. If it isn't, loosen the screws **Y** and **Z** slightly, and tilt the adjustable plate until the feed dog is level. Tighten the screws.

TO REMOVE THE NEEDLE BAR DRIVING SHAFT

If the needle bar driving shaft is to be removed, remove the face plate, the rear cover, the needle bar, and the presser bar assemblies. It is not necessary to drain the oil when performing this work. On the 240W2 and 240W4, remove the thread measuring pull-off finger (a split screwdriver will aid in installing this finger). Remove oil stop screw in rear of arm at the head end to gain access to the two clamping screws in the needle bar driving crank. Loosen these two screws, rotate the driving wheel until the driving shaft crank is in

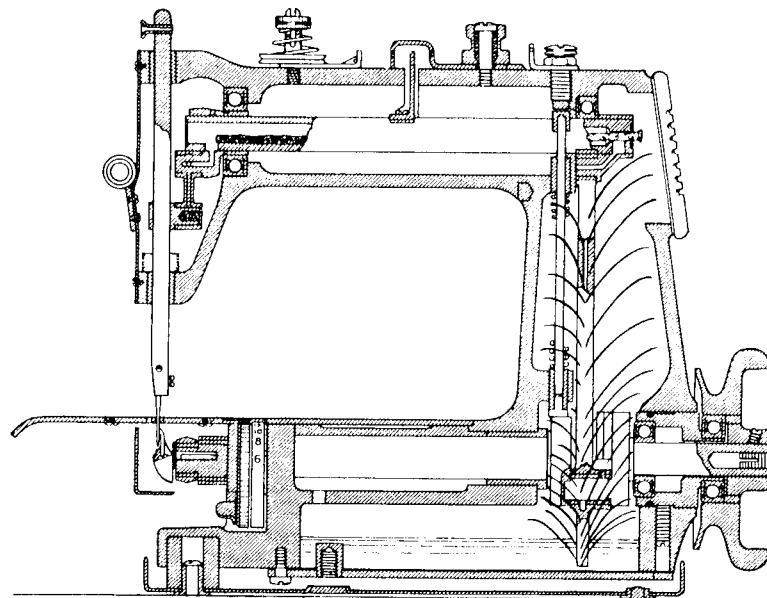

Fig. 27. Cross Section View of 240W Machine

the lowest position, then **press** out driving shaft through rear frame opening. **Hammering on shaft will damage ball bearings.** Press ball bearings on and off shafts in an arbor press. The ball bearings are double sealed bearings and may be installed without regard to position of the faces.

When replacing the shaft, be sure both bearings are seated in the frame before tightening the clamping screws at the front bearing. To position the needle bar driving crank before the final tightening of the two clamping screws, turn the driving wheel until the driving shaft crank is in a horizontal position. Set the needle bar driving crank in a horizontal position, then tighten screws. Lines on the end of the shaft and the needle bar driving crank will be approximately in line when the two parts are properly positioned. Turn driving wheel to check for freedom of the assembly. Install the connecting link, needle bar assembly, presser bar assembly, face plate, frame end cover, and the oil stop screw.

ELIMINATION OF PLAY IN THE LOOPER SHAFT AND NEEDLE BAR DRIVING SHAFT

To eliminate play in the looper shaft which would allow the looper to move toward or away from the needle (one of the causes of skipping), merely loosen the two set screws which hold the driving wheel assembly in place and press the assembly in as the wheel is turned. Remove the cloth plate and check looper shaft play. It should have just the slightest movement to indicate freedom of the needle bar driving connection. Tighten the two screws when a satisfactory condition has been reached.

To eliminate play in the needle bar driving shaft, loosen the two clamping screws mentioned in the paragraph on removing the needle bar driving shaft, squeeze the end of the driving shaft above the driving wheel against the driving crank and tighten the two clamping screws.

TO ELIMINATE LATERAL PLAY IN THE FEED DOG

Be sure screw **B2**, **Fig. 26** on feed bar is tight. Loosen screw **C2**, **Fig. 26** in frame, press end of feed bar carrier hinge stud in lightly while turning driving wheel, then tighten screw. Eliminate all end play of the feed bar hinge stud by adjusting collar **A2**, **Fig. 26**.

TO DISASSEMBLE THE DRIVING WHEEL ASSEMBLY

To remove the driving wheel assembly from the machine, remove frame end cover and drain the oil from the reservoir, loosen the two set screws in the rear and bottom of the frame sufficiently to clear the neoprene ring seal **Fig. 27**. Pull assembly out of the machine frame turning the driving wheel as it is withdrawn. Remove the large screw from the end of the shaft **Fig. 22**, loosen the two set screws in the driving wheel and remove it. Pressed into the driving wheel is a ball bearing which can be removed with special

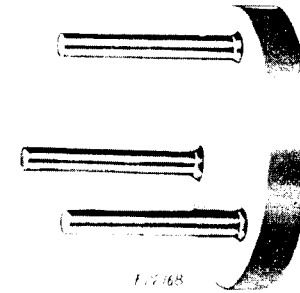

Fig. 28. Tool No. T-4332 for Removing Ball Bearing from Driving Wheel

three pronged tool, (#T-4332) shown in **Fig. 28**. When removing or installing bearings, never hammer on them, always press on the bearing race where the press fit exists, i.e., if the bearing press fit exists between the inner race and a shaft, do not press on the outer race to remove it, and vice versa, unless it is unavoidable.

To remove the driving wheel shaft sleeve from the shaft, use a bearing puller, or place plates under the sleeve, (with the shaft unsupported) and press off in a vice or arbor press. Do the same with the bearing.

Whenever the machine is disassembled, check oil passages to ensure that they are open. Use a fine wire to check the needle bar driving crank, the rear crank, and the needle bar connecting link. Blow through them as an extra check.

TO REPLACE NEEDLE BAR DRIVING SHAFT OIL WICK

If, after a considerable period of operation, the needle bar driving shaft oil wick becomes exceptionally dirty and this dirt impedes the passage of oil, replace the wick. This is done by prying out the disc from which the wick protrudes, drawing a new 6" long, 5/32" diameter wick through to extend 3/16" as shown in **Fig. 29**, and replacing the disc.

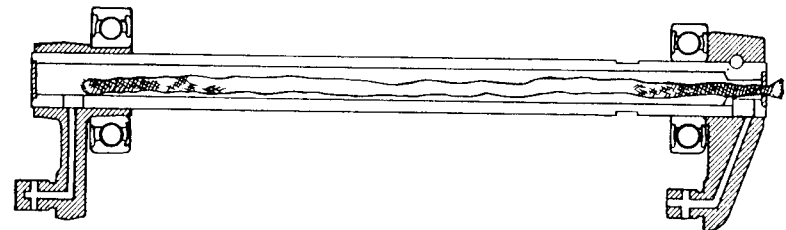

Fig. 29. Cross Section View of Arm Shaft Showing Oil Wick in Position