

INSTRUCTIONS  
FOR USING AND ADJUSTING  
SINGER SEWING MACHINE

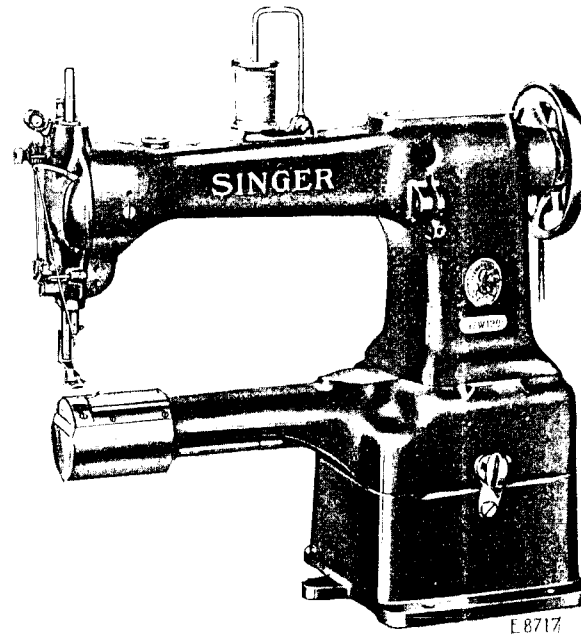

47w120

---

THE SINGER MANUFACTURING CO.

To all whom it may concern:

The placing or renewal of the name "Singer" (Reg. U. S. Pat. Off.) or any of the trade marks of The Singer Manufacturing Company on any machine that has been repaired, rebuilt, reconditioned or altered in any way whatsoever outside a Singer factory or an authorized Singer agency is forbidden.

#### Purchasing of Parts and Needles

Supplies of parts and needles for Singer machines can be purchased at any Singer Shop for the Manufacturing Trade or ordered by mail. If orders are sent by mail, money or a post office order covering their value, including postage, should be enclosed and the order will then be promptly filled and forwarded by mail or express.

Genuine Singer Needles should be used  
in Singer Machines.  
These Needles and their Containers  
are marked with the  
Company's Trade Mark "SIMANCO." 1

Needles in Containers marked  
"For Singer Machines"  
are not Singer made needles. 2

#### DESCRIPTION

Machine 47w120 has one needle and a rotary sewing hook and makes the lock stitch. It is especially designed for mending and darning work in laundries, etc. It is used for repairing table cloths, napkins, towels, stockings, socks, knit underwear, shirts, work clothes, barbers' coats, etc. Tubular shaped articles are conveniently handled on the cylinder bed of the machine.

When desired, the machine can be instantly converted into a flat bed machine by attaching a flat work plate, which is furnished, on order, at an additional charge.

The operator can freely move the work in any direction while darning, as there is no feeding mechanism to interfere with the handling of the work.

#### Speed

The maximum speed recommended for Machine 47w120 is 2000 stitches per minute. The machine should be run slower than the maximum speed at first until the parts which are in movable contact have become glazed by their action upon each other. When the machine is in operation, the balance wheel should always turn over toward the operator.

#### To Oil the Machine

When the machine is received from the factory, it should be thoroughly cleaned and oiled.

Oil should be applied to all oil holes and all other places where there are parts in movable contact. When the machine is in continuous use, it should be oiled at least twice each day.

Oil the bobbin case bearing in the sewing look race each time a bobbin is replaced.

## Needles

Needles for Machine 47w120 are of Class and Variety 126x3 and are made in sizes Nos. 10, 12, 14, 16, 18, 20, 22, 23 and 24.

The size of the needle to be used should be determined by the size of the thread which should pass freely through the eye of the needle. If rough or uneven thread is used or if it passes with difficulty through the eye of the needle, the successful use of the machine will be interfered with.

Orders for needles must specify the quantity required, the size number, also the class and variety numbers separated by the letter x.

The following is an example of an intelligible order:

"100 No. 14, 126x3 Needles."

The best results will be obtained in using the needles furnished by the Singer Sewing Machine Company.

## Thread

Use left twist thread for the needle. Either left or right twist thread may be used for the bobbin.

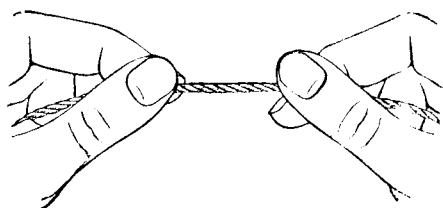

Fig. 2. How to Determine the Twist

Hold the thread as shown above. Then turn the thread over toward you between the thumb and forefinger of the right hand; if left twist, the strands will wind tighter; if right twist, the strands will unwind.

## To Remove the Bobbin

Draw out the slide plate in the bed of the machine and turn the balance wheel over toward you until the point of the sewing hook is toward you.

Place the thumb nail in the groove (D, Fig. 3) in the side of the bobbin case cap, lift the cap and remove the bobbin.

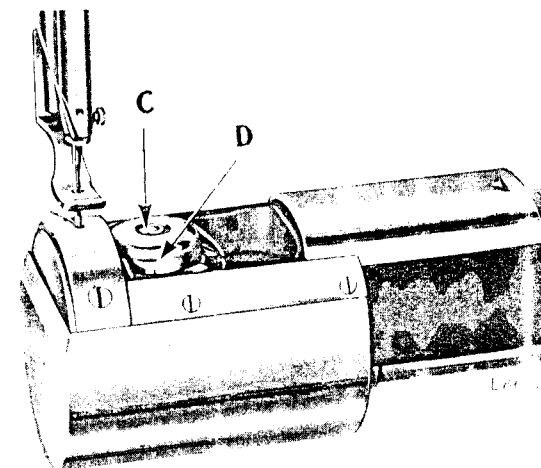

Fig. 3. Bobbin Case Cap in Position in Machine

### To Wind the Bobbin

(See Fig. 4)

Fasten the bobbin winder to the table with its driving pulley in front of the machine belt, so that the pulley will drop away from the belt when sufficient thread has been wound upon the bobbin.

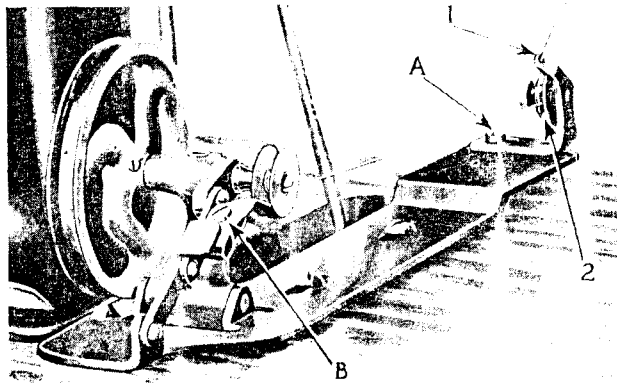

Fig. 4. Winding the Bobbin

Place the bobbin on the bobbin winder spindle and push it on as far as it will go.

Pass the thread down through the thread guide (1) in the tension bracket, around the back and between the tension discs (2). Then wind the end of the thread around the bobbin a few times, push the bobbin winder pulley over against the machine belt and start the machine.

When sufficient thread has been wound upon the bobbin, the bobbin winder will stop automatically.

If the thread does not wind evenly on the bobbin, loosen the screw (A) in the tension bracket and move the bracket to the right or left as may be required, then tighten the screw.

The amount of thread wound on the bobbin is regulated by the screw (B). To wind more thread on the bobbin, turn the screw (B) inwardly. To wind less thread on the bobbin, turn the screw outwardly.

Bobbins can be wound while the machine is stitching.

### To Thread the Bobbin Case Cap

Hold the bobbin between the thumb and forefinger of the right hand, the thread drawing on top from the left toward the right.

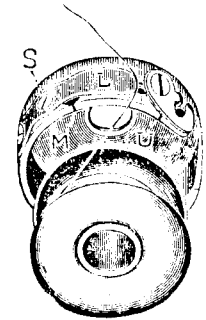

Fig. 5

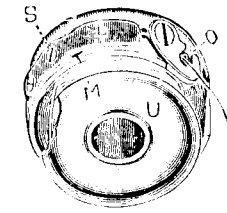

Fig. 6

Threading the Bobbin Case Cap

With the left hand hold the bobbin case cap and place the bobbin into it, as shown in Fig. 5.

Draw the thread under the bobbin case tension spring (L, Fig. 5) and into the slot (M, Fig. 5), back under the tension spring (L), into the slot (U, Fig. 5) and out under the thread guide (O) as shown in Fig. 6. After threading the bobbin case cap, place it on the bobbin case base and push down the latch (C, Fig. 3).

When closing the slide plate in the bed of the machine, draw a loose end of the bobbin thread about two inches long above the slide and leave just enough space for the thread to pass through.

### To Set the Needle

Turn the balance wheel over toward you until the needle bar is at its highest point; loosen the set screw in the lower end of the needle bar and put the needle up into the bar as far as it will go with its long groove toward the left and the eye of the needle directly in line with the cylinder bed of the machine, then tighten the set screw.

### To Thread the Needle

(See Fig. 7)

Place the spool of thread on the spool holder; pass the thread through the leader (1) near the needle bar, then under the thread

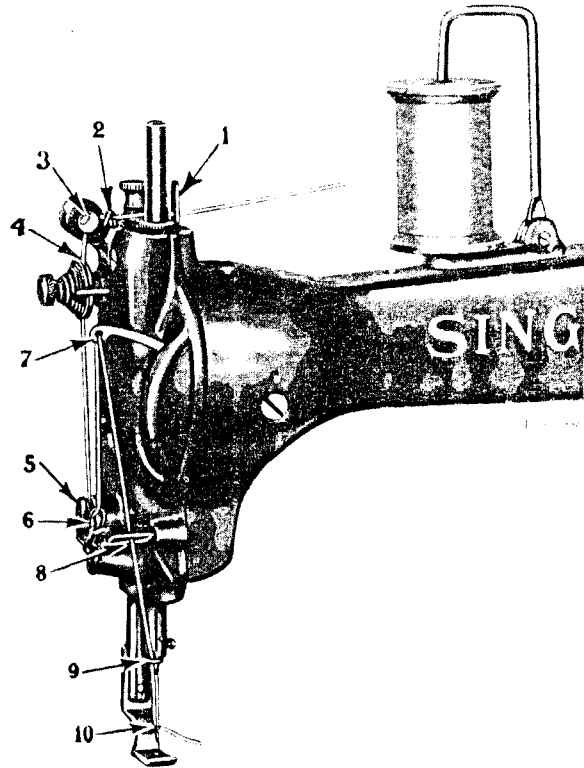

Fig. 7. Threading the Needle

retainer guide wire (2), down through the thread retainer (3), and draw it between the tension discs (4), under and up over the notch in the thread controller (5), under the controller spring (6), thence up through the thread take-up lever (7), down through the thread guide (8), and through the needle bar thread guide (9), threading the needle (10) from the left towards the sewing hook. Draw about two inches of thread through the eye of the needle with which to commence sewing.

### To Prepare for Sewing

With the left hand hold the end of the needle thread, leaving it slack from the hand to the needle. Turn the balance wheel over toward you until the needle moves down and up again to its highest point, thus catching the bobbin thread; draw up the needle thread and the bobbin thread will come up with it through the hole in the throat plate. Lay the threads back under the presser foot and close the slide plate.

### To Commence Darning

Place the work in the machine, having the unworn part near the hole under the needle. Commence the darning by making a

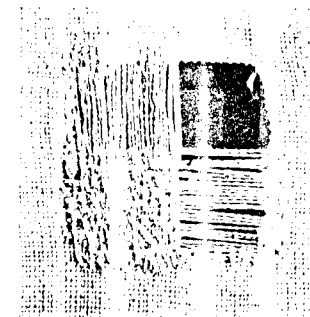

Fig. 8. Darning in Process

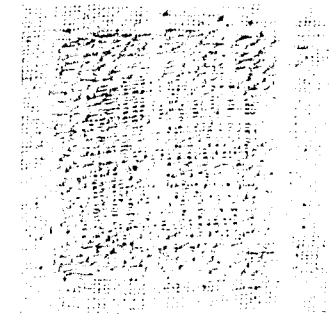

Fig. 9. Darning Finished

line of stitches across the hole a little longer than the width of the hole. Continue making parallel lines of stitches across the hole, moving the work backward and forward and at the same time gradually moving the work sidewise until the hole is covered with lines of stitches running across the hole. Then commence as before and move the work lengthwise of the hole until the stitches across the hole are completely covered and the darn is finished.

When darning flat work, it is advisable to use embroidery hoops to hold the work.

### To Remove the Work

Stop the machine with the thread take-up lever at its highest point, raise the presser foot and draw the work backward, cut the threads close to the goods, leaving two or three inches of thread with which to commence sewing.

### Tensions

The needle and bobbin threads should be locked in the centre of the thickness of the material, thus:



Fig. 10. Perfect Stitch

If the tension on the needle thread is too tight, or if that on the bobbin thread is too loose, the needle thread will lie straight along the upper surface of the material, thus:



Fig. 11. Tight Needle Thread Tension

If the tension on the bobbin thread is too tight, or if that on the needle thread is too loose, the bobbin thread will lie straight along the under side of the material, thus:



Fig. 12. Loose Needle Thread Tension

### To Regulate the Tensions

The tension on the needle thread should only be regulated when the presser foot is down. Having lowered the presser foot, turn the tension thumb nut on the face plate over toward you to increase the tension on the needle thread, or over from you to decrease the tension.

The tension on the bobbin thread is regulated by means of the screw (S, Fig. 5) nearest the centre of the bobbin case cap tension spring. To increase the tension, turn this screw over to the right. To decrease the tension turn the screw over to the left.

When the tension on the bobbin thread has been once properly adjusted, it is seldom necessary to change it, as a correct stitch can usually be obtained by varying the tension on the needle thread.

## INSTRUCTIONS

FOR

### ADJUSTERS AND MACHINISTS

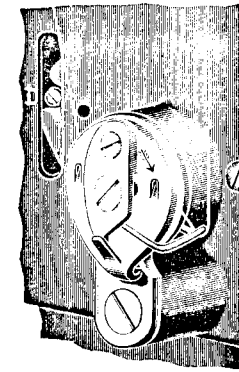

Fig. 13

### Thread Controller

The function of the thread controller spring is to hold back the slack of the upper thread until the eye of the needle reaches the goods in its descent.

When once correctly adjusted to thin material, the stop is automatically adapted to varying thicknesses by the rise and fall of the presser bar.

To change the stop for more controller action on the thread, loosen screw (D, see Fig. 13) which projects through the slot in the face plate, and set it lower, and for less action set it higher.

It may be found advisable to increase the tension of the spring for coarse thread, or lessen it for fine.

To vary the tension of the controller spring, remove the face plate and loosen the small set screw at the right of the controller (see Fig. 13) which sets the thread controller stud, then from the inside turn the stud forward or backward as required by using a screw driver in the slot of the screw which holds the thread controller stop and retighten the set screw. In any case when an unusually light tension is used, the tension on the controller spring should be correspondingly light. The coils of the controller spring should be oiled occasionally.

**To place a new thread controller in position.** Remove the entire thread controller by taking out the largest screw (see Fig. 13) and release the spring by removing the middle screw. (Be careful not to lose the small roller.) Place the new spring, the roller and screw in their positions. Next put the entire thread controller on the face plate, taking care to slide the little tail, on the coil of the spring, into the notch in the stud over which the coil slides.

Oil the small roller occasionally.

### To Set the Needle Bar

The needle bar which is in the machine when shipped from the factory, has upon it (about two inches from the bottom) two lines  $\frac{3}{32}$  inch apart. When the needle bar is at its lowest point set it so that its highest mark is even with the underside of the arm head.

**To set a new needle bar which has no mark.** Set the needle bar so that when it rises  $\frac{3}{32}$  inch from its lowest position, the point of the hook will be at the centre of the needle and about  $\frac{1}{16}$  inch above the eye.

### To Adjust the Hook to and from the Needle

If the hook runs too far from or too near the needle, loosen the hook saddle screws just enough to permit the saddle to be driven with light blows to the position desired, and retighten the hook saddle screws.

## To Time the Sewing Hook

To see if the sewing hook is in correct time, remove the slide and throat plate and turn the balance wheel over toward you until the needle bar has passed its lowest position and has risen so that the lower mark on it is even with the underside of the arm head. If in correct time, the point of the sewing hook will be at the centre of the needle and  $\frac{1}{16}$  inch above the eye. If the hook is not in correct time, loosen the screws in the bevel gear on the shaft under the hook and turn the gear forward or backward until the hook is in time as instructed above, then tighten the screws in the bevel gear.

On very heavy work, it may be necessary to set the needle bar a little lower and the hook slightly slower than the above rule.

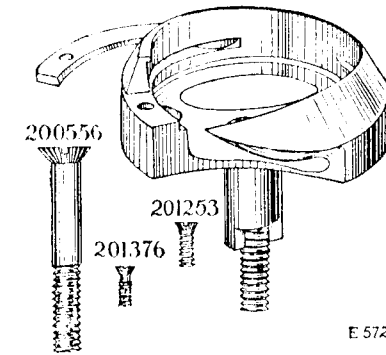

Fig. 14

### To Remove the Hook from the Machine

Remove the hook gib screw at the heel of the hook and move the gib aside to allow the base of the bobbin case to be taken out, after which remove the screw, shown in Fig. 14, from the centre of the hook. Tapping the hook lightly on the bottom of its rim will force it from its socket. Do not try to pry it out, as prying may bend the shank of the hook. In replacing the hook, be sure that the prongs of the shank properly enter the slot at the bottom of the socket, otherwise the hook will be out of time.

### To Remove the Arm Shaft

Through the large hole near the presser bar, loosen the set screw and remove the check and position screws from the take-up cam; detach the arm shaft connections from the upper cranks, remove the balance wheel, loosen the arm shaft bushing (back) position screw and drive the bushing out, then draw out the arm shaft.

#### To Remove the Arm Shaft Bushing (Front)

Loosen its position screw at the back of the arm, and after removing the needle bar, take-up cam, etc., insert a brass rod through the bushing (back) hole and drive the front bushing out.

#### To Remove the Arm Shaft Bushing (Centre)

Loosen its position screw and insert a brass rod from the front and drive the bushing out.

### Take-up Cam and End Play of Shaft

When replacing the arm shaft bushings, see that the grooves are in line for the position screws to enter, and tighten the screws. When setting the take-up cam be sure to replace its position screw in the hole nearest to the presser bar when the screw holes are uppermost, turn the position screw firmly into the shaft, and the check screw upon it. The end play of the upper shaft is taken up by means of the screw in the end of the shaft at the balance wheel.

### Balance Wheel

The balance wheel is counterbalanced to prevent excessive vibration of the machine and the shaft is grooved for the position screw to enter and correctly locate the counterbalance.

Place the balance wheel on the shaft so that the screw farthest from you will enter the groove in the shaft.