

**SINGER**  
95-10

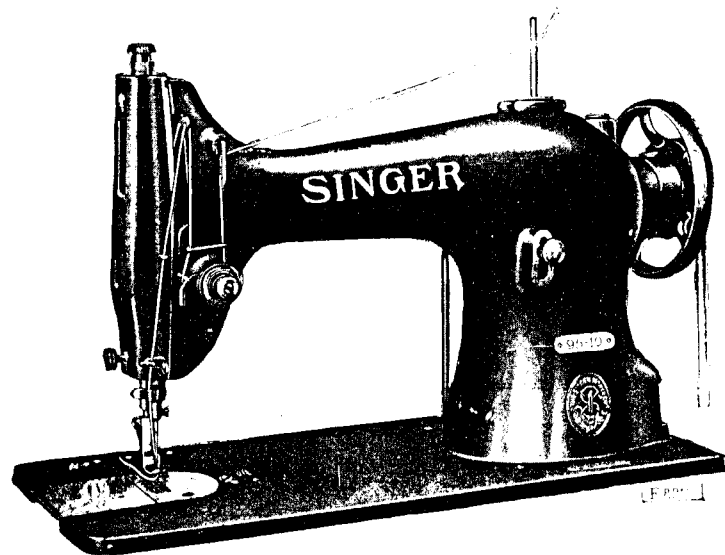

### DESCRIPTION

Machine 95-10 makes the lock stitch and is designed for sewing light and medium weight fabrics at high speed. It has the gear driven rotary hook.

### Speed

The maximum speed recommended for Machine 95-10 is 3500 stitches per minute. The machine should be run slower than the maximum speed until the parts which are in movable contact have become glazed by their action upon each other. If the fabric to be sewn is very closely woven or filled with dressing, the high speed of the machine may cause the needle to become heated. In such cases the speed must, of course, be reduced.

### Needles

Needles for Machine 95-10 are of Class and Variety 88 x 1, and are furnished in the following sizes, Nos. 9, 11, 14, 16, 17 and 18.

The size of the needle to be used should be determined by the size of the thread which must pass freely through the eye of the needle. If rough or uneven thread is used, or if it passes with difficulty through the eye of the needle, the successful use of the machine will be interfered with.

Orders for needles must specify the *quantity* required, the *size* number, also the *class* and *variety* numbers separated by an x.

The following is an example of an intelligible order:

“100 No. 14, 88 x 1 Needles.”

The best stitching results will be obtained in using the needles furnished by the Singer Sewing Machine Company.

### Thread

Left twist thread should be used in the needle. Either right or left twist thread can be used in the bobbin.

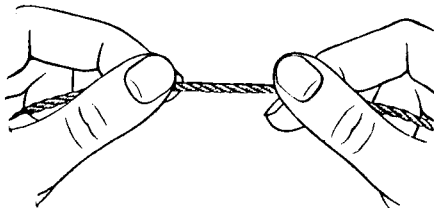

FIG. 2. HOW TO DETERMINE THE TWIST

Hold the thread as shown above. Turn the thread over toward you between the thumb and forefinger of the right hand; if left twist, the strands will wind tighter; if right twist, the strands will unwind.

### Relative Sizes of Needles and Thread

The following sizes of needles and thread are recommended according to the class of work:

SIZES OF NEEDLES	CLASSES OF WORK	SIZES OF COTTON AND SILK
9	Very Fine Work.	90 to 100 Cotton OO Silk
11	Mulls, Japanese Silk, Chiffon, etc.	80 to 90 Cotton O Silk
14	Shirtings, Sheetings, Calicoes, Muslins, Silks, Dress Goods and all classes of general work.	60 to 80 Cotton A and B Silk
16 and 17	All kinds of heavy Calicoes, light Woolen Goods, heavy Silk, Seaming, Stitching, etc.	40 to 60 Cotton C Silk
18	Tickings, Upholstery, Woolen Goods, Trousers, Boys' Clothing, Cloaks, etc.	30 to 40 Cotton D Silk

### To Ensure Perfect Action of the Machine

The balance wheel must always turn over toward the operator.

Do not run the machine with the presser foot resting on the feed without cloth under the presser foot.

Do not run the machine when both bobbin case and needle are threaded unless there is material under the presser foot.

Do not try to help the machine by pulling the fabric lest you bend the needle; the machine feeds the work without assistance.

The slide over the bobbin case should be kept closed when the machine is in operation.

### To Remove the Bobbin

Turn the balance wheel over toward you until the needle moves up to its highest point. Draw out the slide in the bed of

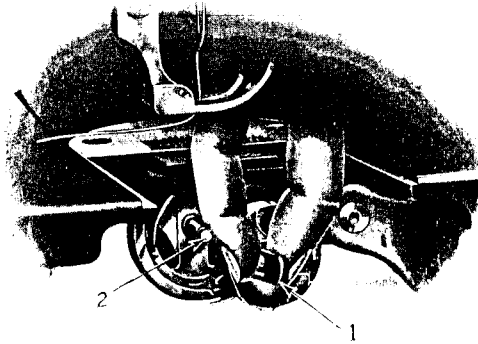

FIG. 3. REMOVING THE BOBBIN

the machine, reach down with the thumb and forefinger of the left hand, open the bobbin case latch (1, Fig. 3) with the thumb and lift out the bobbin case. While the latch remains open, the bobbin is retained in the bobbin case. Release the latch, turn the open end of the bobbin case downward and the bobbin will drop out.

### To Wind the Bobbin

(SEE FIG. 4)

Fasten the bobbin winder to the table with its driving pulley in front of the machine belt, so that the pulley will drop away from the belt when sufficient thread has been wound upon the bobbin.

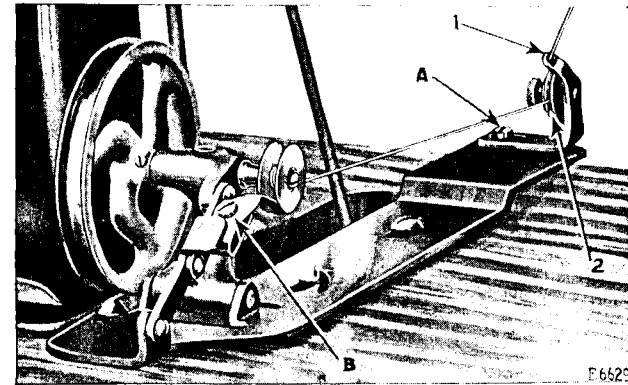

FIG. 4. WINDING THE BOBBIN

Place the bobbin on the bobbin winder spindle and push it on as far as it will go.

Pass the thread down through the thread guide (1) in the tension bracket, around the back and between the tension discs (2). Then wind the end of the thread around the bobbin a few times, push the bobbin winder pulley over against the machine belt and start the machine.

When sufficient thread has been wound upon the bobbin, the bobbin winder will stop automatically.

If the thread does not wind evenly on the bobbin, loosen the screw (A) in the tension bracket and move the bracket to the right or left as may be required, then tighten the screw.

The amount of thread wound on the bobbin is regulated by the screw (B). To wind more thread on the bobbin, turn the screw (B) inwardly. To wind less thread on the bobbin, turn this screw outwardly.

Bobbins can be wound while the machine is stitching.

### To Thread the Bobbin Case

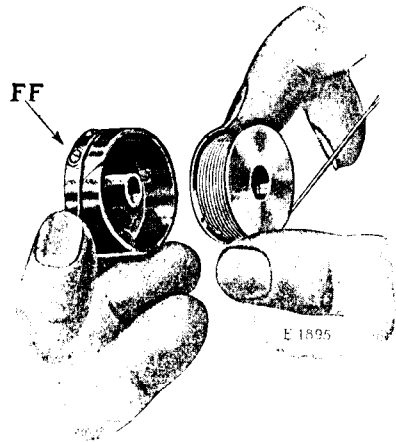

FIG. 5

Hold the bobbin between the thumb and forefinger of the right hand, as shown in Fig. 5, the thread drawing on the bottom from the left toward the right.

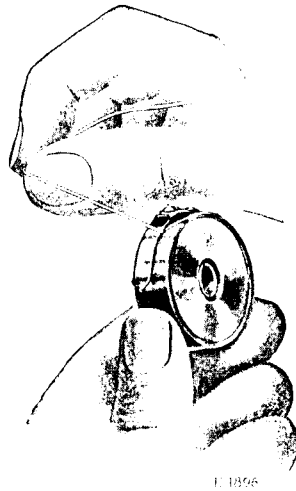

FIG. 6

With the left hand hold the bobbin case as shown in Fig. 5, the slot in the edge being near the top, and place the bobbin into it.

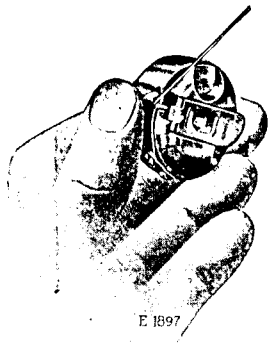

FIG. 7

Then pull the thread into the slot in the edge of the bobbin case as shown in Fig. 6; draw the thread under the tension spring and into the delivery eye at the end of the tension spring (see Fig. 7).

### To Replace the Bobbin Case

After threading, take the bobbin case by the latch, holding it between the thumb and forefinger of the left hand, place the

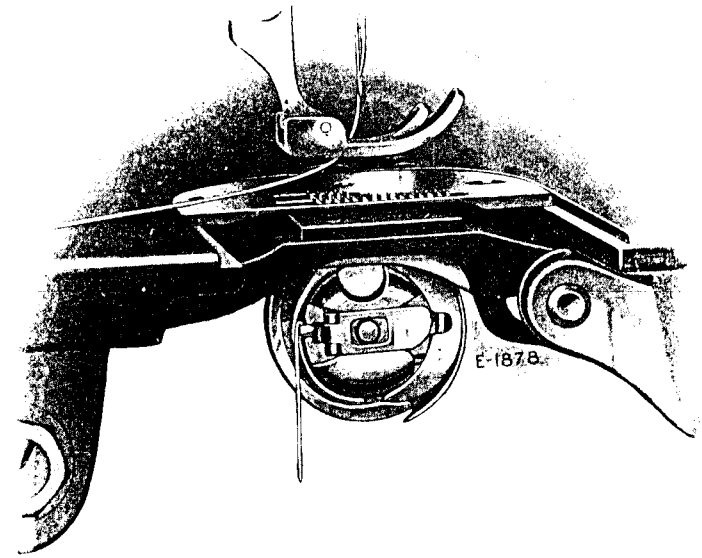

FIG. 8. BOBBIN CASE THREADED AND REPLACED

bobbin case on the centre stud (2, Fig. 3, page 4) of the bobbin case holder, release the latch and press the bobbin case back until the latch catches the groove near the end of the stud (see Fig. 8). Allow about two inches of thread to hang free and replace the slide in the bed of the machine.

### To Set the Needle

Turn the balance wheel over toward you until the needle bar moves up to its highest point; loosen the screw (JJ, Fig. 14, page 11) in the lower end of the needle bar and put the needle up into the bar as far as it will go, with the long groove of the needle toward the left and the eye of the needle directly in line with the arm of the machine, then tighten the screw.

### To Thread the Needle

Pass the thread from the unwinder, or from the spool on the spool pin on the top of the machine, from right to left through

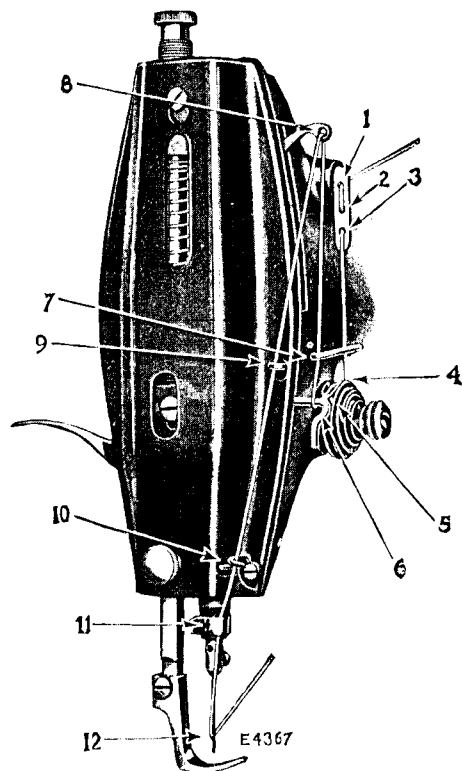

FIG. 9. THREADING THE NEEDLE

the top hole (1) in the thread retainer, from left to right through the centre hole (2) in the thread retainer, and from right to left through the bottom hole (3) in the thread retainer, down from right to left between the tension discs (4), into the thread take-up spring (5), under the slack thread regulator (6), up and back of the wire thread guide (7), up and from right to left through the hole in the end of the thread take-up lever (8), down through the thread guide (9), down through the thread eyelet (10), into the thread guide (11), and from left to right through the eye of the needle (12). Draw about two inches of thread through the eye of the needle with which to commence sewing.

### To Prepare for Sewing

With the left hand hold the end of the needle thread, leaving it slack from the hand to the needle, turn the balance wheel over

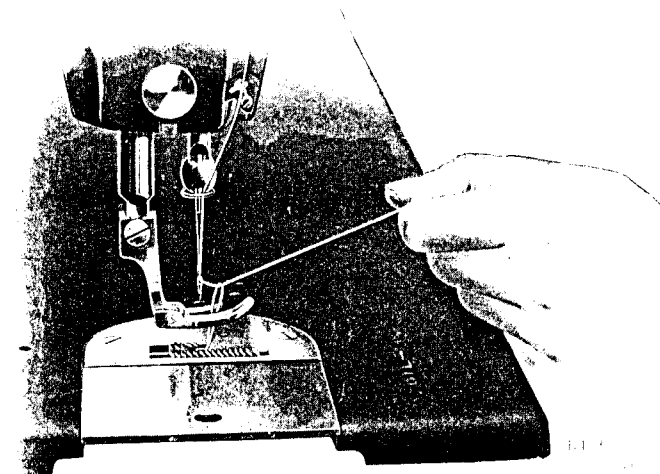

FIG. 10. DRAWING UP THE BOBBIN THREAD

toward you until the needle moves down and up again to its highest point, thus catching the bobbin thread; draw up the needle thread and the bobbin thread will come up with it through the hole in the throat plate (see Fig. 10). Lay both threads back under the presser foot.

### To Commence Sewing

Place the material beneath the presser foot, lower the presser foot and commence to sew, turning the balance wheel over toward you.

### To Remove the Work

Let the thread take-up lever rest at its highest point, raise the presser foot and draw the work back and cut the threads close to the goods.

### Tensions

For ordinary stitching, the needle and bobbin threads should be locked in the centre of the thickness of the material, thus:



FIG. 11. PERFECT STITCH

If the tension on the needle thread is too tight, or if that on the bobbin thread is too loose, the needle thread will lie straight along the upper surface of the material, thus:



FIG. 12. TIGHT NEEDLE THREAD TENSION

If the tension on the bobbin thread is too tight, or if that on the needle thread is too loose, the bobbin thread will lie straight along the under side of the material, thus:



FIG. 13. LOOSE NEEDLE THREAD TENSION

### To Regulate the Tensions

The tension on the needle thread should only be regulated when the presser foot is down. Having lowered the presser foot, turn the small thumb nut (HH, Fig. 14, page 11) at the front of the tension discs over to the right to increase the tension. To decrease the tension, turn this thumb nut over to the left.

The tension on the bobbin thread is regulated by the large screw (FF, Fig. 5, page 6) in the tension spring on the outside of the bobbin case. To increase the tension, turn this screw over to the right. To decrease the tension, turn this screw over to the left.

When the tension on the bobbin thread has been once properly adjusted, it is seldom necessary to change it, as a correct stitch can usually be obtained by varying the tension on the needle thread.

### To Regulate the Length of Stitch

The length of stitch is regulated by the thumb screw (KK, Fig. 14) in the slot on the front of the upright part of the arm. To lengthen the stitch, loosen this thumb screw and move it downwardly. To shorten the stitch, loosen this thumb screw and move it upwardly. When the desired length of stitch has been obtained, tighten the thumb screw (KK).

### To Regulate the Pressure on the Material

The pressure on the material is regulated by the thumb screw (GG, Fig. 14.) To increase the pressure, turn this thumb screw over to the right. To decrease the pressure, turn this thumb screw over to the left.

### To Oil the Machine

To ensure easy running and prevent unnecessary wear of the parts which are in movable contact, the machine requires oiling.

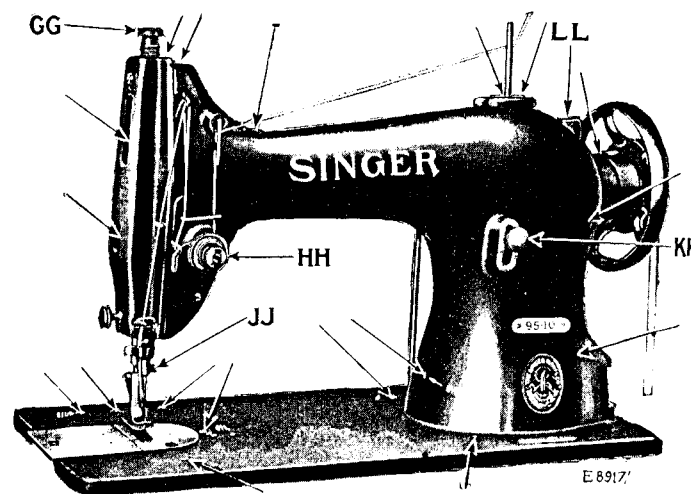

FIG. 14. OILING POINTS AND ADJUSTMENTS AT THE FRONT OF THE MACHINE

Oil should be applied at the places as shown by arrows in Figs. 14, 15 and 16, and when the machine is in continuous use

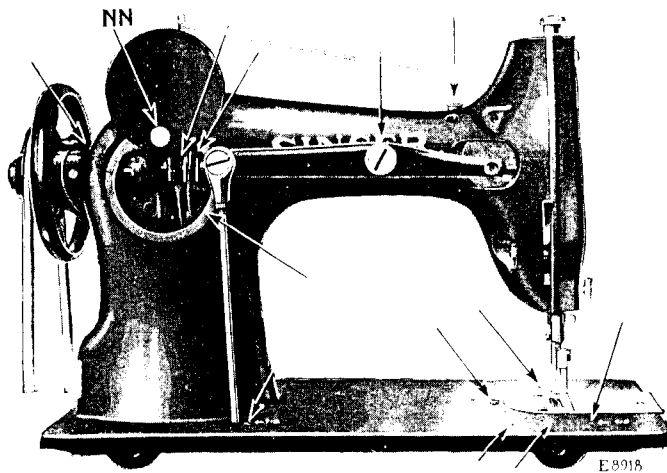

FIG. 15. OILING POINTS AT THE BACK OF THE MACHINE

it should be oiled at least twice each day. Loosen the thumb screw (NN, Fig. 15) in the round cover plate on the back of the machine, turn the cover plate up and oil the bearings which are thus uncovered.

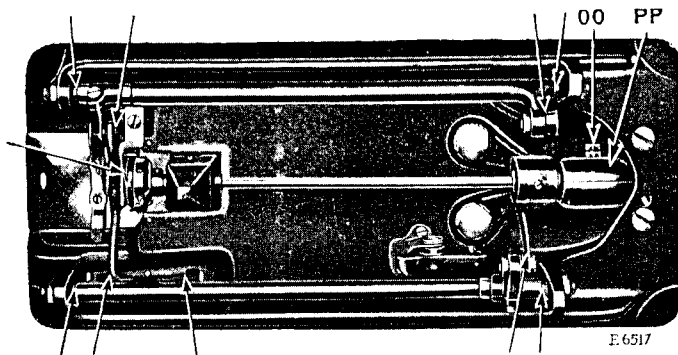

FIG. 16. BASE OF MACHINE, SHOWING OILING POINTS

### Special Notice

Sufficient oil should be applied to the wicking which is retained in the oil tube (LL, Fig. 14) to keep the wicking saturated. This tube conducts the oil to the arm shaft gears.

Turn the machine back on its hinges and apply oil at the places as shown by arrows in Fig. 16.

Occasionally remove the knurled thumb screw (OO, Fig. 16) and fill the gear case (PP, Fig. 16) with the Singer High Speed Lubricant, a grease which is especially prepared for this purpose, then replace the thumb screw (OO).

Oil should be regularly applied to the bobbin case holder bearing in the sewing hook race.



### To Set the Needle Bar at the Correct Height

See that the needle is pushed up into the needle bar as far as it will go, then remove the face plate.

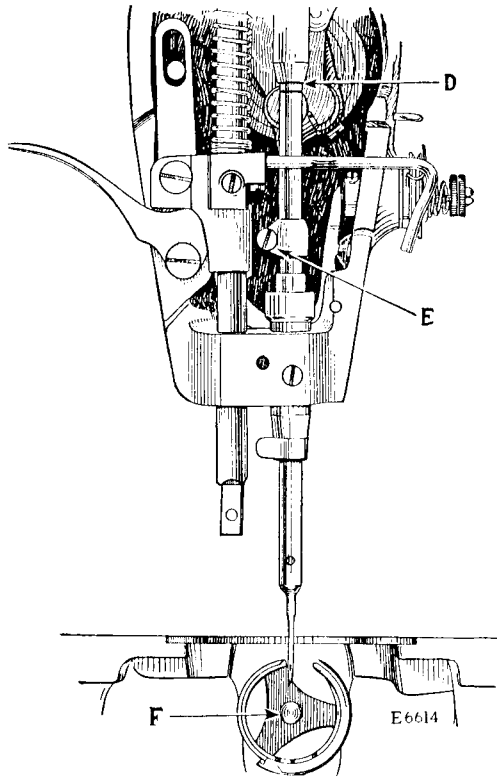

FIG. 17. SHOWING NEEDLE BAR SET AT THE CORRECT HEIGHT

The needle bar which is in the machine when shipped from the factory has two timing marks near its upper end.

Turn the balance wheel over toward you, until the needle bar moves down to its lowest point. When the needle bar is in this position, the **upper timing mark** on the needle bar should be centred with the lower end of the needle bar bushing, as shown at D, in Fig. 17.

In case the needle bar is not set at the correct height, loosen the screw (E, Fig. 17) in the needle bar connecting stud and move the needle bar up or down until the **upper timing mark** is centred with the lower end of the needle bar bushing, as shown at D, in Fig. 17, then securely tighten the screw (E).

### To Time the Sewing Hook

Remove the slide plate and bobbin case. Take out the screw (G, Fig. 18) and remove the bobbin case holder position bracket

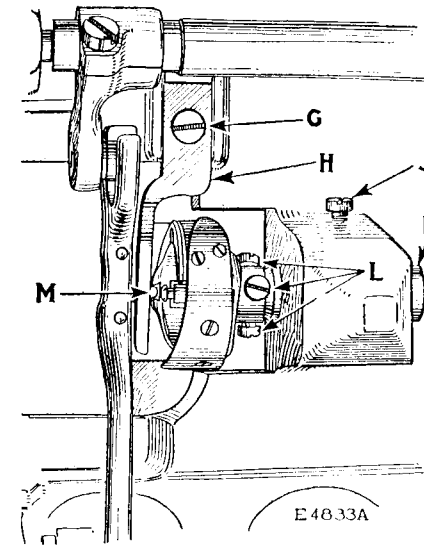

FIG. 18. VIEW OF UNDERSIDE OF MACHINE SHOWING BOBBIN CASE HOLDER POSITION BRACKET (H) AND ADJUSTMENTS ON MACHINE

(H, Fig. 18). Take out the three screws (N, Fig. 19) and remove the rotating hook section (O, Fig. 19) and bobbin case holder (P, Fig. 19). This will give a clear view of the point of the hook and the needle for the purpose of timing.

Remove the bobbin case (Q, Fig. 21) until it is in the position shown in Fig. 21. The hook can then be removed from the hook shaft.

In placing a new sewing hook on the shaft, have the (U) of the hook at the bottom and the bobbin case turned to the position shown in Fig. 21, so that the ear the feed bar (S).

When the hook is in position on the shaft, turn the bobbin case (P, Fig. 21) until the notch (T, Fig. 21) is at the top, the bobbin case holder position bracket (H, Fig. 18), and look to see that the position stud (M, Fig. 18) enters the hole at the top of the bobbin case holder, as shown in Fig. 18,

To determine whether the hook is correctly timed, turn the balance wheel over toward you until the **lower timing mark** on

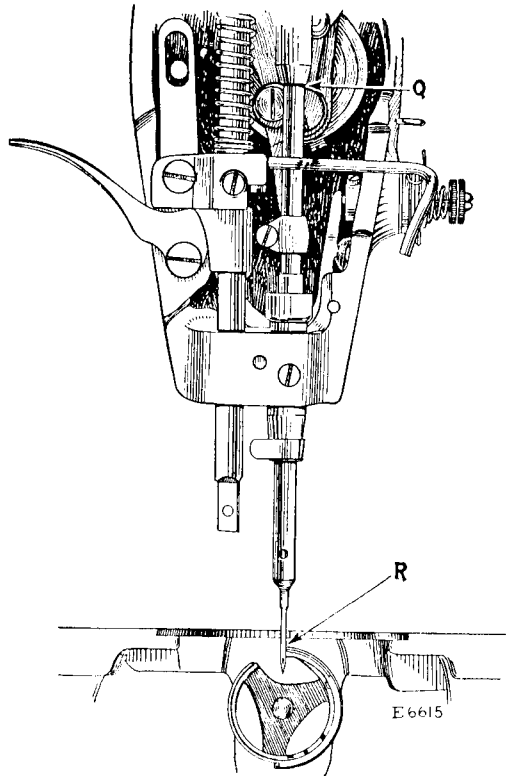

FIG. 20. NEEDLE AND SEWING HOOK CORRECTLY TIMED

the needle bar is centred with the lower end of the needle bar bushing, as shown at Q, in Fig. 20, when the needle bar is on

FIG. 17. SHOWING NEEDLE BAR SET AT THE CORRECT position, the needle, as

The needle bar which is in the machine when the factory has two timing marks near its upper end, three screws Turn the balance wheel over toward you, until the needle moves down to its lowest point. When the needle is in the correct position, the **upper timing mark** on the needle should be centred with the lower end of the needle bar bushing. If the needle is set too far out or too far in, the needle will not be correctly timed.

In case the needle bar is not set at the correct position, the bushing the screw (E, Fig. 17) in the needle bar connecting it in or out, the needle bar up or down until the **upper timing mark** on the needle is centred with the lower end of the needle bar bushing. Tighten the screw (E), in Fig. 17, then securely tighten the screw (E).

### To Remove and Replace the Sewing Hook

Remove the needle, slide plate and bobbin case. Take out the screw (G, Fig. 18, page 17) and remove the bobbin case holder

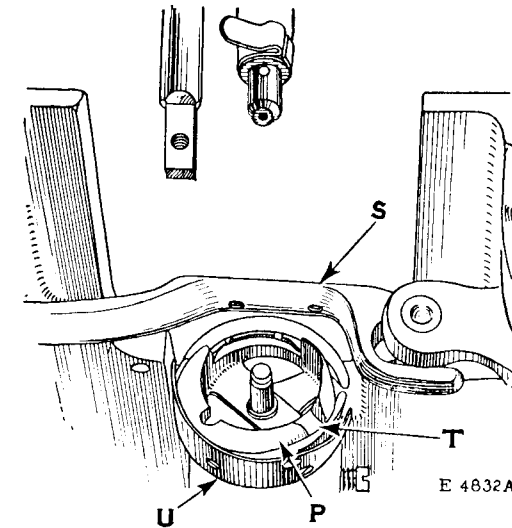

FIG. 21. SHOWING CORRECT POSITION OF THREAD GUARD (U) AND BOBBIN CASE HOLDER (P) FOR REMOVAL OF SEWING HOOK

position bracket (H, Fig. 18). Loosen the three set screws (L, Fig. 18) in the hub of the hook, then turn the balance wheel over toward you until the feed bar (S, Fig. 21) is raised to its highest point. Turn the sewing hook until the thread guard (U, Fig. 21) is at the bottom, as shown in Fig. 21, and turn the bobbin case holder (P, Fig. 21) until it is in the position shown in Fig. 21. The sewing hook can then be removed from the hook shaft.

When replacing a new sewing hook on the shaft, have the thread guard (U) of the hook at the bottom and the bobbin case holder (P) turned to the position shown in Fig. 21, so that the hook will clear the feed bar (S).

When the hook is in position on the shaft, turn the bobbin case holder (P, Fig. 21) until the notch (T, Fig. 21) is at the top, then replace the bobbin case holder position bracket (H, Fig. 18), being careful to see that the position stud (M, Fig. 18) enters the notch at the top of the bobbin case holder, as shown in Fig. 18,

then securely fasten the position bracket by means of the screw (G, Fig. 18). Replace the needle and time the sewing hook as instructed on pages 17 and 18. When tightening the three screws (L, Fig. 18) in the hub of the hook, draw the hook shaft toward the needle bar end of the machine and press the hook toward the balance wheel so as to take up the end play in the shaft. Then replace bobbin case and slide plate.

### To Remove and Replace the Sewing Hook Shaft

Remove the sewing hook as instructed on page 19. Take out the screw (V, Fig. 22) and remove both sections of the gear case (W, Fig. 22), then wipe the grease away from the gears.

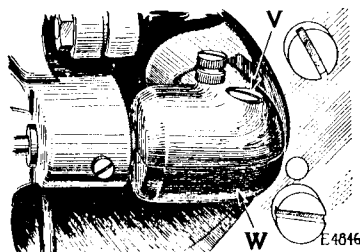

FIG. 22. VIEW OF UNDERSIDE OF MACHINE, SHOWING GEAR CASE

Before removing the hook shaft (X, Fig. 23) from the machine, the gears (Y and Z, Fig. 23) should be marked, using chalk or a red pencil to mark one of the teeth of the gear (Y) and the space of the gear (Z) in which the marked tooth meshes. This is important, as the gears may become dislodged when removing the hook shaft, and the marks will enable you to retain the original relative positions of the gears.

To remove the hook shaft, loosen the two set screws in the gear (Y, Fig. 23), then insert the new hook shaft into the gear

(Y), from the right hand end, pushing the old shaft out of the gear, toward the needle bar by means of the new shaft as shown

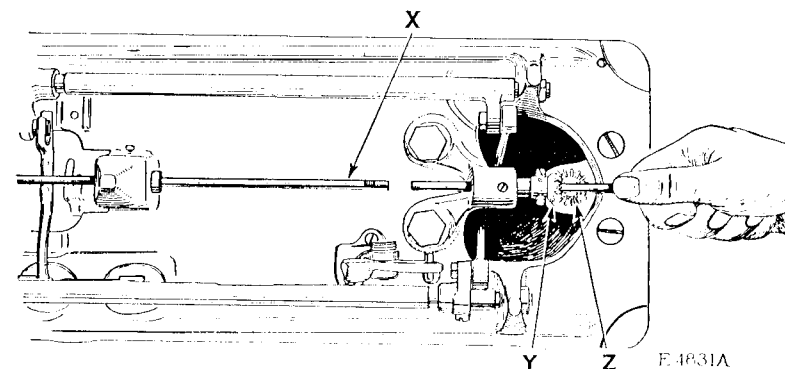

FIG. 23. REMOVING AND REPLACING SEWING HOOK SHAFT

in Fig. 23. By removing the old shaft in this manner, the relative positions of the gears (Y and Z) will not be disturbed. When placing the new shaft into position in the machine, see that the flat portion near one end of the shaft is at the right so that one of the set screws in the gear (Y, Fig. 23) will bear against it when the gear is fastened in position on the shaft. The shaft should be set so that its left end is flush with the body of the sewing hook as shown at F, in Fig. 17, page 16. It is advisable to remove the rotating hook section as instructed on page 17, and take out the bobbin case holder so that you can see whether the end of the shaft is flush with the body of the hook. When the shaft is correctly positioned, securely tighten the two set screws in the gear (Y), taking care that one of the screws bears against the flat portion of the shaft. Then time the sewing hook as instructed on pages 17 and 18, and replace the bobbin case holder and rotating hook section. Pack both halves of the gear case (W, Fig. 22) with Singer Lubricant, replace the gear case and securely fasten it in position by means of the screw (V, Fig. 22).

### To Time the Feeding Mechanism

The feeding mechanism should be timed so that the feed dog starts its feeding movement (away from the operator) when the

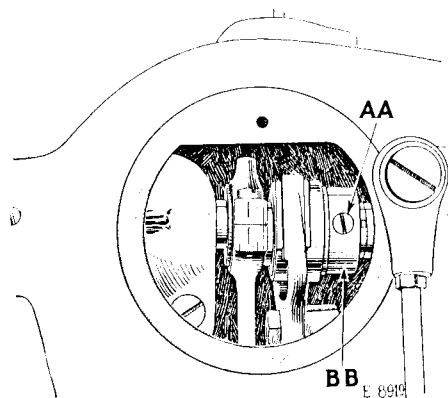

FIG. 24. ADJUSTMENT FOR TIMING FEEDING MECHANISM

needle bar commences its downward stroke. The feed should always finish its feeding movement before the needle reaches the goods on its downward stroke.

When it is necessary to time the feeding mechanism, press the stitch regulator (KK, Fig. 14, page 11) down to its lowest point for the longest stitch and turn up the round cover plate at the back of the machine. Loosen the feed eccentric set screw (AA, Fig. 24) and turn the feed eccentric (BB, Fig. 24) until the feed is correctly timed as instructed above, then securely tighten the set screw (AA).

### To Adjust the Thread Take-up Spring

The thread take-up spring (CC, Fig. 25) should be set so that when the eye of the needle reaches the goods on the downward

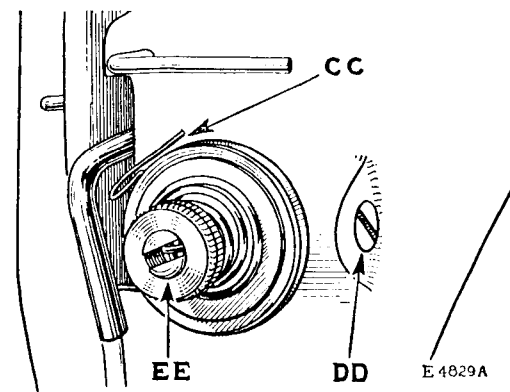

FIG. 25. ADJUSTMENT OF THREAD TAKE-UP SPRING

stroke of the needle bar, the spring will be through acting and will rest against the stop on the thread take-up spring regulator. If the thread take-up spring is not correctly set, as instructed above, loosen the set screw (DD, Fig. 25) in the arm of the machine, and turn the tension stud (EE, Fig. 25) to the right for more movement of the spring or to the left for less movement. When the spring is correctly set, securely tighten the set screw (DD).

The tension on the thread take-up spring (CC) is regulated by turning the tension stud (EE) to the right to increase the tension, or to the left to decrease the tension. The tension on the thread take-up spring should be just sufficient to take up the slack of the needle thread until the eye of the needle reaches the goods in its descent.

### Purchasing of Parts and Needles

Supplies of parts and needles for Singer machines can be purchased at any Singer shop or ordered by mail. If orders are sent by mail, money or a post office order covering their value, including postage, should be enclosed and the order will then be promptly filled and forwarded by mail or express.